

Jordi & Jamil Instruments



SURGICAL instruments
Catalogue

Company Profile

We at **Jordi & Jamil** welcome you to the world of reliable quality in the products where it matters the most, to the world of precision, where lack of it could be a matter of life and death.

Jordi & Jamil is an industry leader in manufacturing and providing worldwide solutions for SURGICAL / DENTAL / DIAGNOSTIC & HOLLOW WARE instruments.

Our Professionals continually strive to satisfy your technical and clinical needs of surgical instruments.

We maintain a team work environment throughout the company by placing experienced members on critical manufacturing processes in instrument craftsmanship with state-of-the-art precision manufacturing equipments and the latest technologies to achieve the highest possible results.

Our instruments range from precision micro handheld surgical instruments(including forceps, clamps, scissors, needle holders, cutting and clasping devices) used in general surgery, ophthalmic, neurosurgical, ENT and cardiovascular specialties to macro instruments used in spinal, orthopedic and other surgical areas.

Jordi & Jamil holds worldwide recognized certifications such as:

ISO 9001	ISO 7151
CE Certified	ISO 17664:2004
EN 13485:2012	ISO 13402
ISO 7153-1	ISO 15223

Which ensures our clientage that they are in best hands when it comes to quality of the instruments as well as their compliance with the international standards.

Our Quality policy ensures that every instrument is manufactured to its highest quality by maintaining quality checks at every stage, as it is our belief that our success depends on establishing enduring relationships with our customers and consistently producing high quality products that meet their demanding standards and timetables.



Production View





















	<p>01</p>	<p>Percussion Hammers & Aesthesiometers Tongue Depressors Diagnostic Sets Examination & Measuring Instruments Dissecting Knives Scalpels, Tenotomes & Resection Knives</p>	<p>Page 01-21</p>
	<p>02</p>	<p>Scissors</p>	<p>Page 22-70</p>
	<p>03</p>	<p>Probes Cotton Applicators Suture Clips Clip Applying Forceps And Removing Forceps</p>	<p>Page 71-77</p>
	<p>04</p>	<p>Self-Retaining Retractors Abdominal Retractors</p>	<p>Page 78-102</p>
	<p>05</p>	<p>Sponge and Dressing Forceps Washing Forceps Organ and Tissue Grasping Forceps Towel Clamps</p>	<p>Page 103-111</p>
	<p>06</p>	<p>Bone Punches Rongeurs Amputation</p>	<p>Page 112-130</p>

TABLE OF CONTENTS

Page 131 - 147	Dissecting and Tissue Forceps	07	
Page 148 - 156	Obstetrics Tracheotomy	08	
Page 157 - 185	Haemostatic Forceps	09	
Page 186 - 222	Ent Surgery	10	
Page 223 - 241	Elevators Bone Levers Raspatories Bone Files Bone Curettes	11	
Page 242	Trocars	12	

	<p>13</p>	<p>Vaginal Specula</p>	<p>Page 243 - 253</p>
	<p>14</p>	<p>Wound Retractors</p>	<p>Page 254 - 288</p>
	<p>15</p>	<p>Dilators Biopsy Instruments And Curettes Uterine Probes, Uterine Dressing - Tenaculum Ovum Forceps Uterine Elevating Forceps</p>	<p>Page 289 - 311</p>
	<p>16</p>	<p>Cardiovascular And Thoracic Surgery Muller Vessel Clips Bulldog Clamps</p>	<p>Page 312 - 374</p>
	<p>17</p>	<p>Needle Holders Suture Instruments Ligature Needles Guiding Probes</p>	<p>Page 375 - 395</p>
	<p>18</p>	<p>Gall Bladder, Liver and Spleen Instruments Genito Urinary Instruments</p>	<p>Page 396 - 406</p>

TABLE OF CONTENTS

Page 407 - 463	<p>Mallets Tempers, Chisels, Gouges Bone Holding Forceps Rongeurs Bone Cutting Forceps Meniscus Instruments</p> <p>Wire Extension Hand Drills, Awls Reamers Bone Biopsy Instruments Finger Nail Instruments</p>	19	
Page 464 - 470	Plaster Instruments	20	
Page 471 - 499	NeuroSurgery Laminectomy	21	
Page 500 - 534	Abdominal Surgery Intestinal and Rectal Instruments	22	
Page 535 - 551	Micro Instruments	23	
Page 552 - 564	Suction Instruments	24	

Page 1-21

- Percussion Hammers & Aesthesiometers
- Tongue Depressors
- Diagnostic Sets
- Examination & Measuring Instruments
- Dissecting Knives
- Scalpels, Tenotomes & Resection Knives

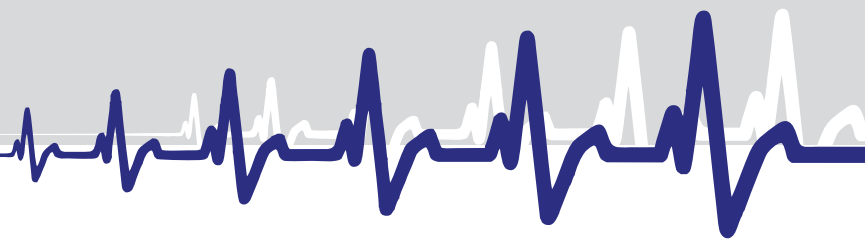

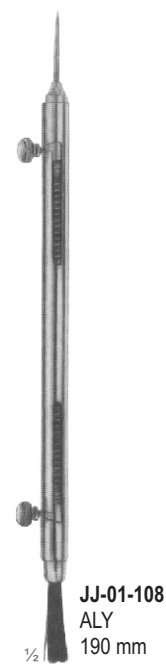
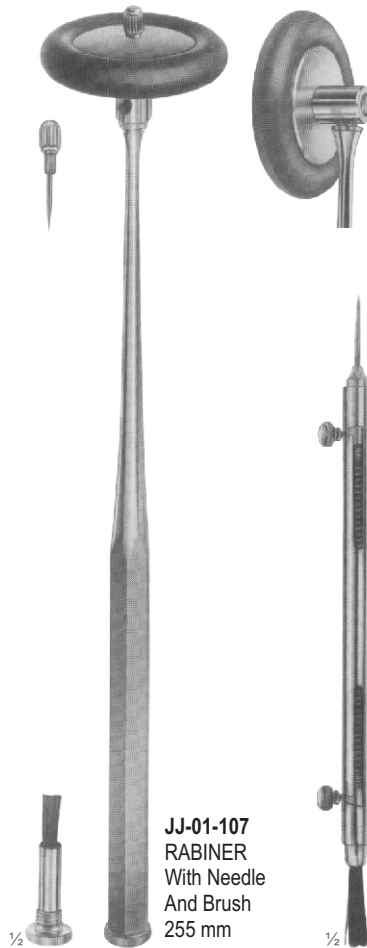
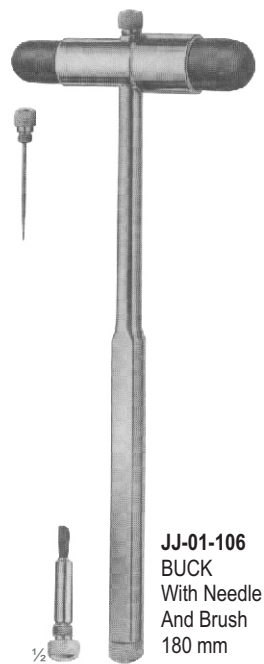
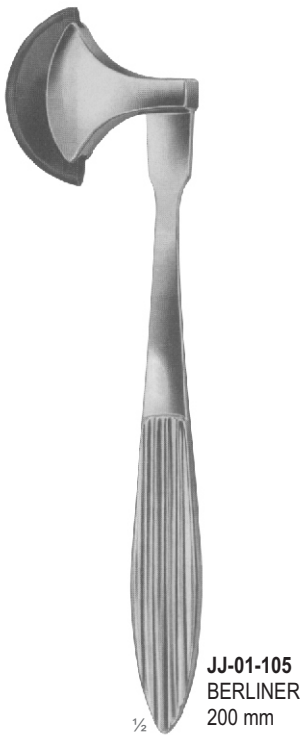
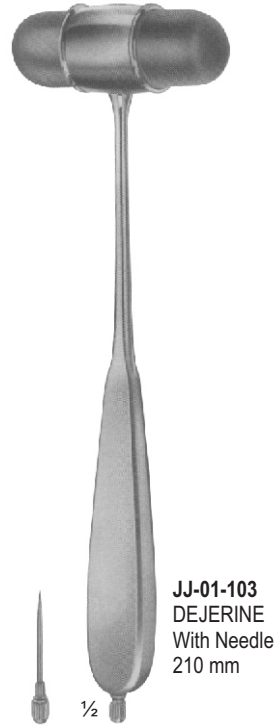

TONGUE DEPRESSORS

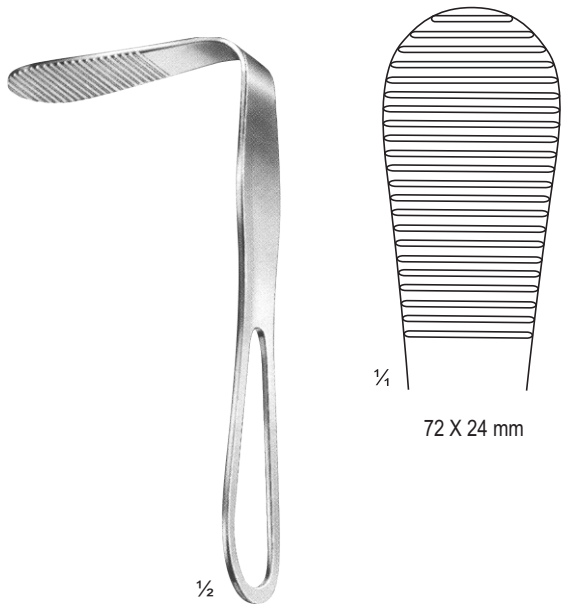

JJ-01-110
HARTMANN
150 mm

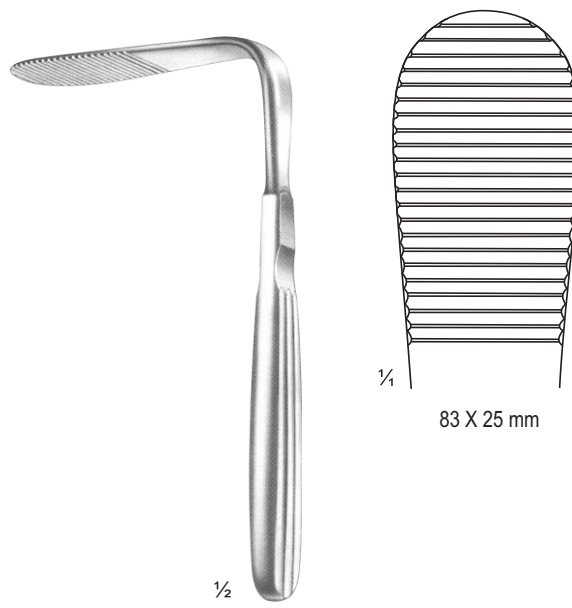

JJ-01-111
TOBOLD
150 mm



JJ-01-112
TOBOLD
160 mm

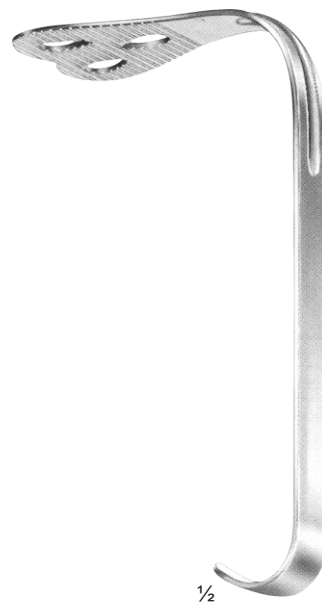

JJ-01-113 - JJ-01-114
WIEDER

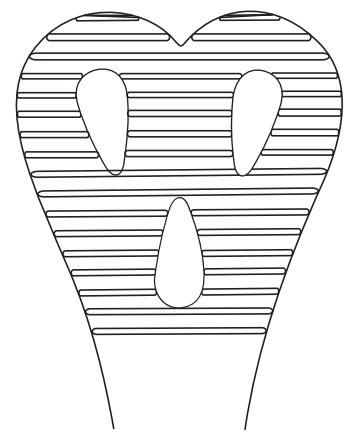

JJ-01-113
15 cm
43 mm

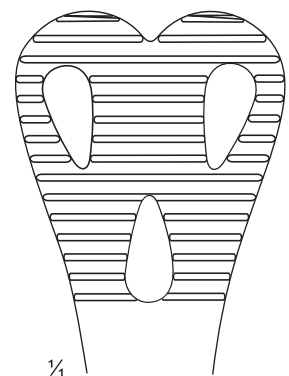

JJ-01-114
140 mm
36 mm



1/2
JJ-01-115
150 mm

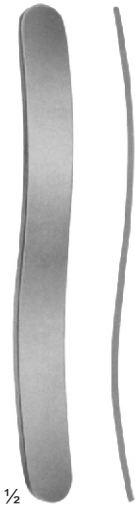

1/2
JJ-01-116
145 mm



1/2
JJ-01-117
140 mm

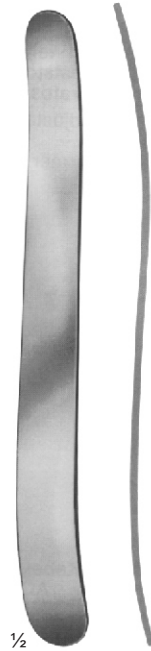

1/2
JJ-01-118
BUCHWALD
180 mm

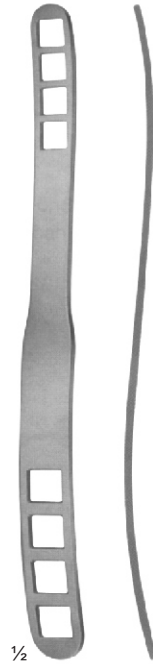

1/2
JJ-01-119
BRUNINGS
190 mm

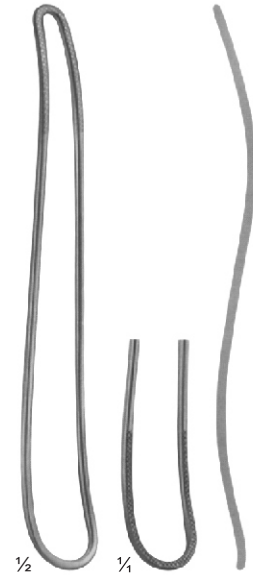

1/2 1/4
JJ-01-120
FRENZEL
165 mm

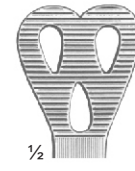

1/2
150 mm



1/2
140 mm

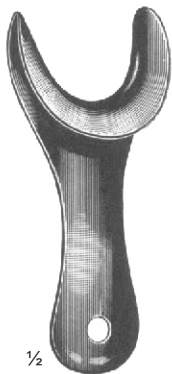

1/2
JJ-01-121
SIMPLEX
110 mm



JJ-01-122
STEMBERG
120 mm, 140 mm, 160 mm

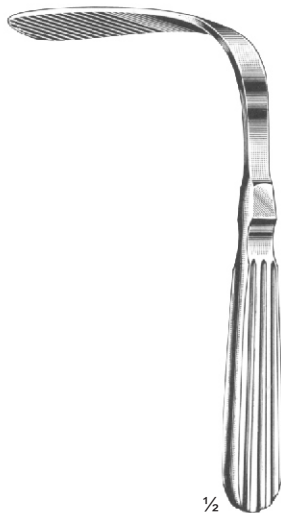

1/2
JJ-01-123
TOBOLD
145 mm



1/2
JJ-01-124
ANDREW
110 mm



1/2
JJ-01-125
WIEDER

INSTRUMENTS FOR ANAESTHESIA AND TONGUE FORCEPS



1/2

JJ-01-126
HEISTER
Mouth Gag
Size: 130 mm

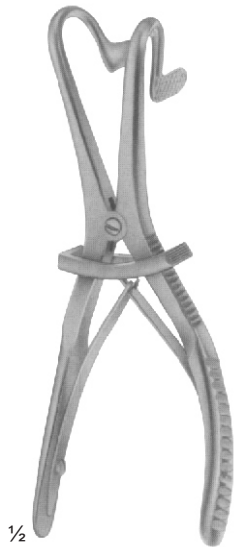

1/2

JJ-01-127
FERGUSSON-ACKLAND
Mouth Gag
Size: 145 mm



1/2

JJ-01-128
DENHARDT
Mouth Gag With Silicon
Inserts, Interchangeable
Size: 125 mm



1/2

JJ-01-129
ROSER KONIG
Mouth Gag
Size: 160 mm,
185 mm

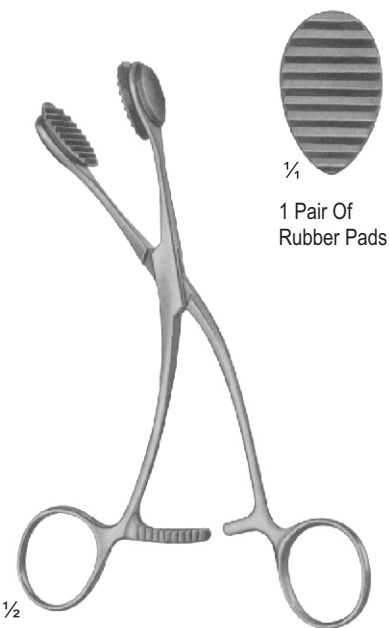

1/2

JJ-01-130
YOUNG
165 mm



1/4

1 Pair Of
Rubber Pads

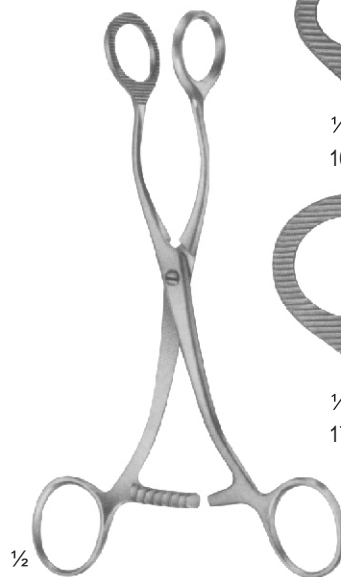

1/2

JJ-01-131
COLLIN
160 mm, 170 mm



1/4

160 mm



1/4

170 mm

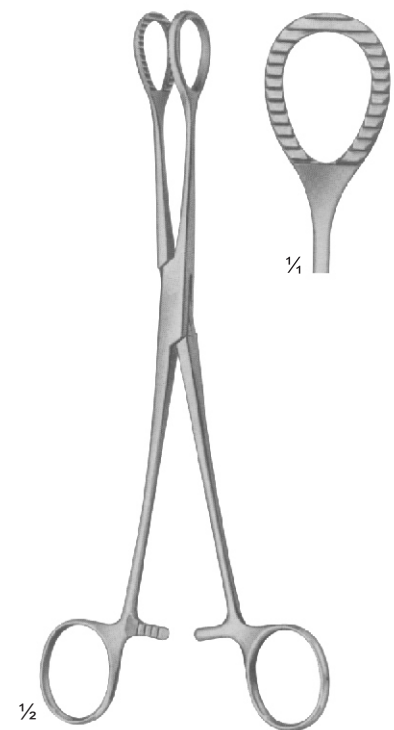

1/2

JJ-01-132
HEYWOOD-SMITH modif.
215 mm



JJ-01-133
Infants
150 mm



JJ-01-134
Children
200 mm



JJ-01-135
Adults
250 mm



JJ-01-133 - JJ-01-135
MAGILL



JJ-01-136
TUBING CLAMP
7", 8"
180 mm, 200 mm



JJ-01-137
Medium battery handle
only, 25 mm diam.



JJ-01-138
Spare bulb
2.7 volt, for
autosopes



JJ-01-139
Spare bulb
2.6 volt, for
ophthalmoscopes



JJ-01-140
Otoscope Set, Consists Of
Battery Handle Without Batteries,
3 Ear Specula, 1 Bulb In Velvet Lined Case



JJ-01-141
Diagnostic Set, Otoscope With Three Specula,
Nasal Speculam, Lamp Holder, Two Laryngeal
Mirrors, Tongue Blade Holder

DIAGNOSTIC SETS (LARYNGOSCOPE)



1/3

JJ-01-142
MILLER
 Laryngoscope Set, Consists Of Battery Handle
 (Without Battery) With Four Miller
 Laryngoscope Blades

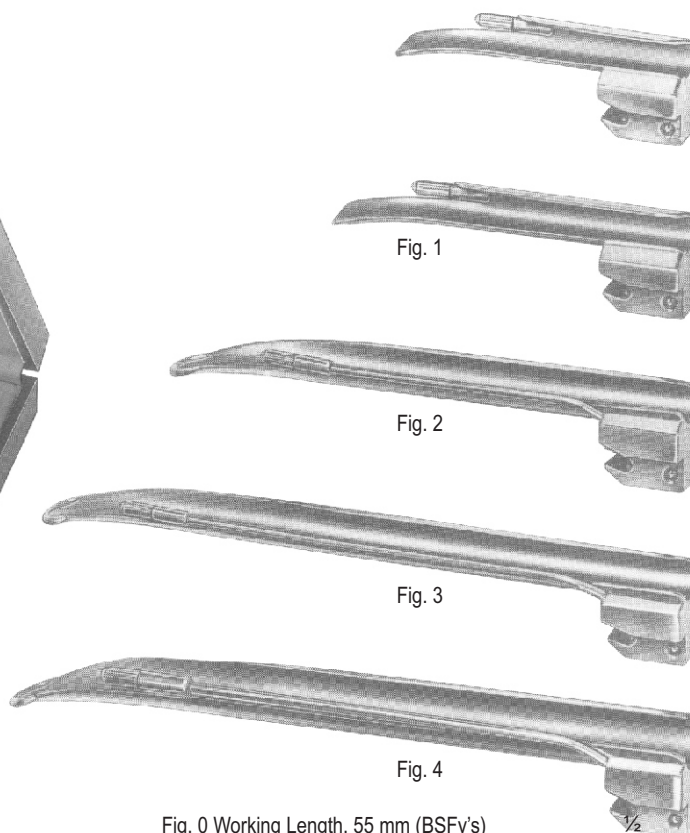

Fig. 0 Working Length, 55 mm (BSFy's)
 Fig. 1 Working Length, 80 mm (Children's)
 Fig. 2 Working Length, 130 mm (Adolescent's)
 Fig. 3 Working Length, 170 mm (Women's)
 Fig. 4 Working Length, 180 mm (Men's)



1/3

JJ-01-143
GUEDEL-NEGUS
 Laryngoscope Set, Consists Of Battery Handle
 (Without Battery) With Four Miller
 Laryngoscope Blades

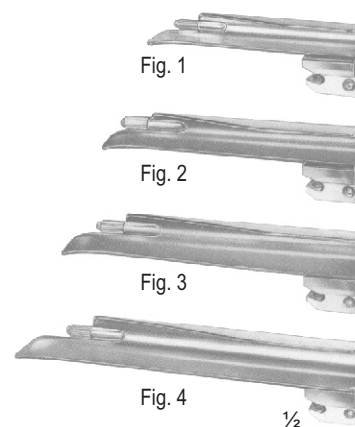
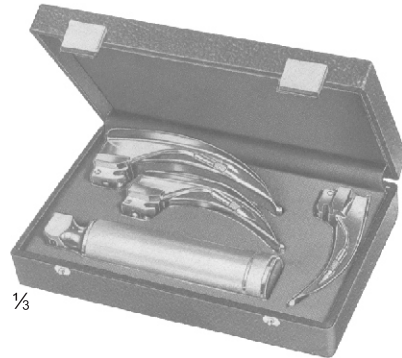

Fig. 1 Working Length, 70 mm (Children's)
 Fig. 2 Working Length, 90 mm (Adolescent's)
 Fig. 3 Working Length, 110 mm (Women's)
 Fig. 4 Working Length, 135 mm (Men's)



JJ-01-144
McIntosh
Laryngoscope Set, Consists Of Battery Handle
(Without Battery) With Three McIntosh Blades,
Fig. 1, Fig. 2, Fig. 3

1/3

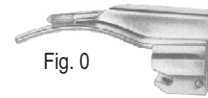

Fig. 0

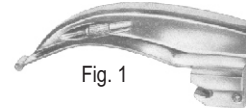

Fig. 1

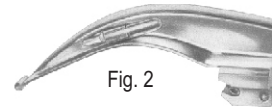

Fig. 2

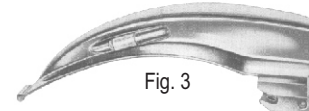

Fig. 3

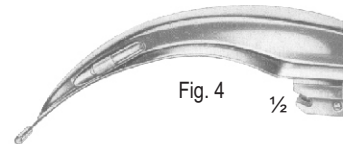
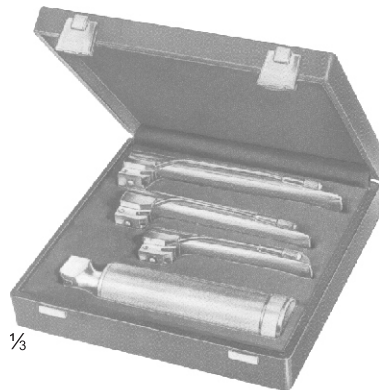

Fig. 4

1/2

JJ-01-145
McIntosh
Laryngoscope Set, Consists Of Battery Handle (Without Battery)
With Five McIntosh Blades, Fig. 1, Fig. 2, Fig. 3, Fig. 4, Fig. 5

- Fig. 0 Working Length, 55 mm (BSFy's)
- Fig. 1 Working Length, 75 mm (Children's)
- Fig. 2 Working Length, 90 mm (Adolescent's)
- Fig. 3 Working Length, 110 mm (Women's)
- Fig. 4 Working Length, 135 mm (Men's)



JJ-01-146
6GER
Laryngoscope Set, Consists Of
Battery Handle (Without Battery)
With Three Foregger Blades,
Fig. 1, Fig. 2, Fig. 3,

1/3



Fig. 1



Fig. 2



Fig. 3

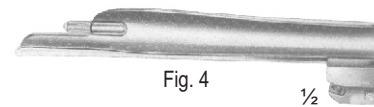

Fig. 4

1/2

JJ-01-147
FOREGGER
Laryngoscope Set, Consists Of
Battery Handle (Without Battery)
With Five Foregger Blades,
Fig. 1, Fig. 2, Fig. 3, Fig. 4, Fig. 5

- Fig. 1 Working Length, 70 mm (Children's)
- Fig. 2 Working Length, 90 mm (Adolescent's)
- Fig. 3 Working Length, 110 mm (Women's)
- Fig. 4 Working Length, 135 mm (Men's)



1/2

JJ-01-148
Fiber Optic
Battery Handle



1/2

JJ-01-149
Fiber Optic
Battery Handle



1/4

JJ-01-150
Replacement Lamp
(Krypton) 2.5 V



1/4

JJ-01-151
Replacement Lamp
(Halogen) 2.5 V

EXAMINATION & MEASURING INSTRUMENTS



JJ-01-152
Boley



Metal: **JJ-01-153**
Wax : **JJ-01-154**
Double Side Marking
Iwanson

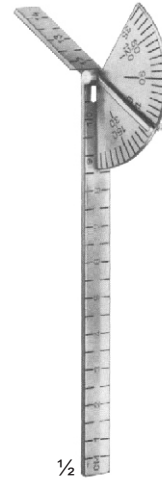

JJ-01-155
CAROLL
140 mm



JJ-01-156
TOWNLEY
100 mm

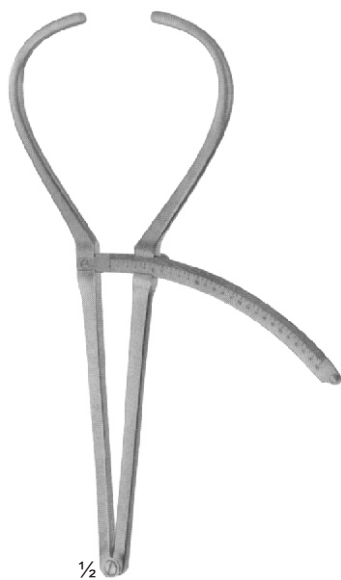

JJ-01-157
BERTILLON
Caliper For Measuring The Head
320 mm

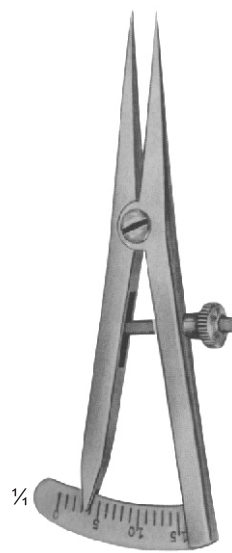

JJ-01-158
CASTROVIEJO
Caliper

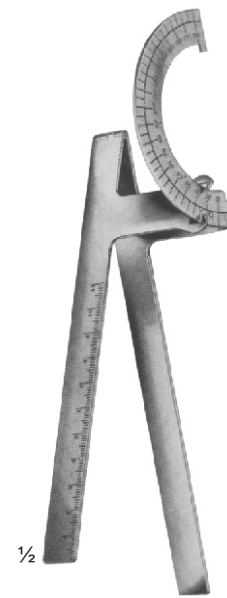

JJ-01-159
MOLTGEN
Goniometer



JJ-01-160 - JJ-01-169
Fig. 1 - 10



JJ-01-160
Fig. 1



JJ-01-161
Fig. 2



JJ-01-162
Fig. 3



JJ-01-163
Fig. 4



JJ-01-164
Fig. 5



JJ-01-165
Fig. 6



JJ-01-166
Fig. 7



JJ-01-167
Fig. 8



JJ-01-168
Fig. 9



JJ-01-169
Fig. 10

SCALPELS, TENOTOMES & RESECTION KNIVES

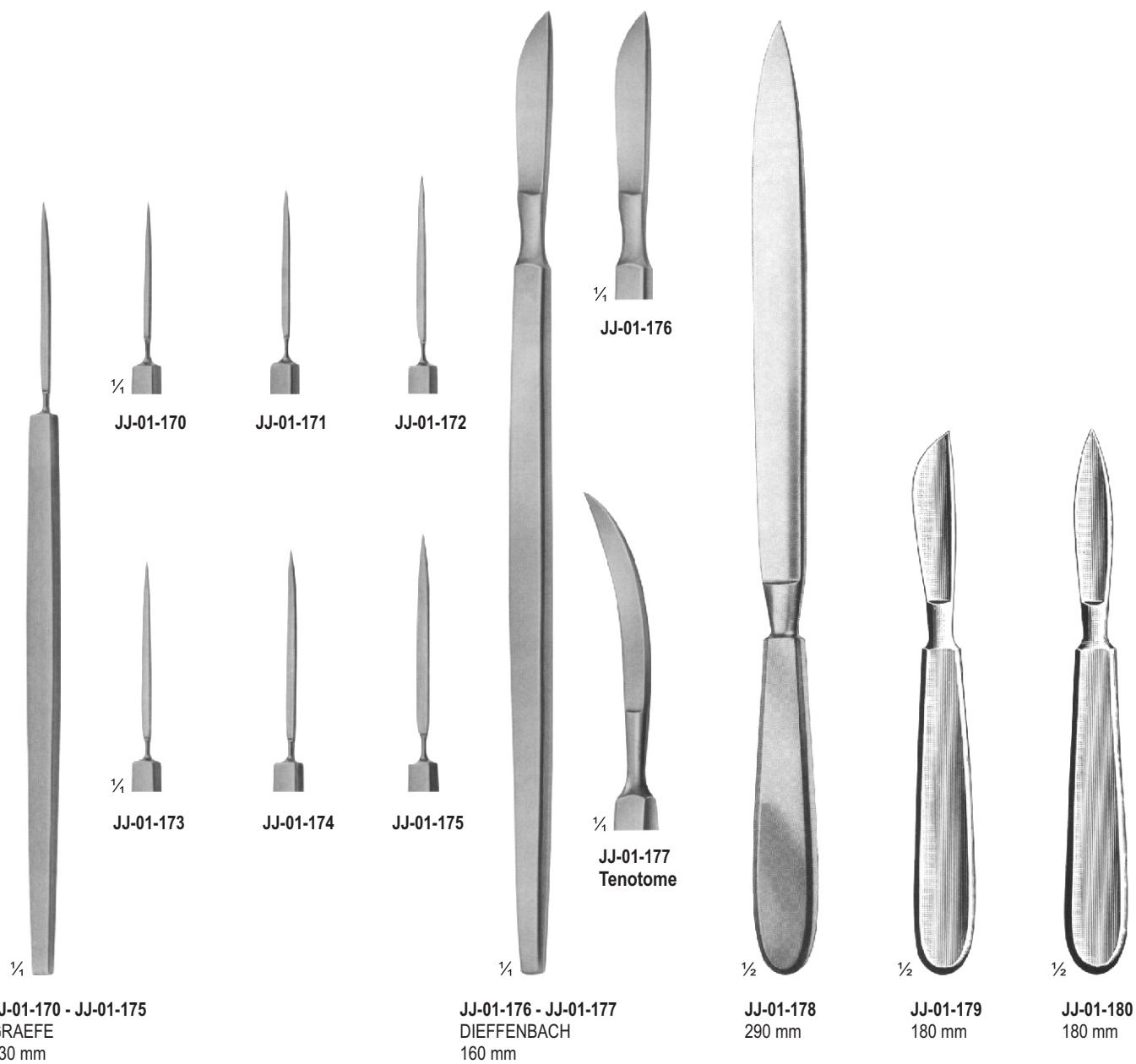



JJ-01-181
130 mm
JJ-01-182
160 mm
JJ-01-183
190 mm
JJ-01-184
200 mm

Blade Length
Amputating Knives

JJ-01-185
CATLIN
160 mm
Blade Length
Amputating
Knives

JJ-01-186
LANGENBECK
120 mm
Blade Length
Flap Knives

JJ-01-187
110 mm
Blade Length
Interosseous
Knives

JJ-01-188
55 mm
Blade Length
With Raspatory,
Wooden Handle

JJ-01-189
70 mm
Blade Length
Wooden Handle

JJ-01-190
80 mm
Blade Length
Metal Handle

JJ-01-191
195 mm
Blade Length
Metal Handle

CONE KNIVES, MYOMATOME, TRIGEMINAL & TONSIL KNIVES



JJ-01-192
AYRE
 235 mm
 Cone Knife

JJ-01-193
 230 mm
 Cone Knife

JJ-01-194
SEGOND
 270 mm
 Myomatome

JJ-01-195
OLIVECRONA
 205 mm
 Trigeminal
 Knife

JJ-01-196
 230 mm
 Trigeminal
 Knife

JJ-01-197
FOWLER
 200 mm
 Tonsil Knife

JJ-01-198
SFRAHAM
 215 mm
 Tonsil Knife

JJ-01-199
BRUNINGS
 215 mm
 Tonsil Knife

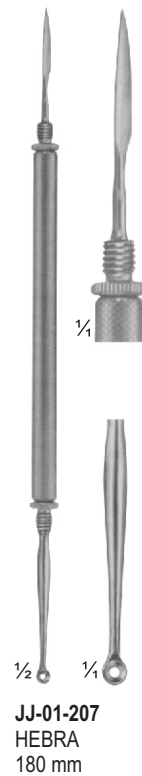
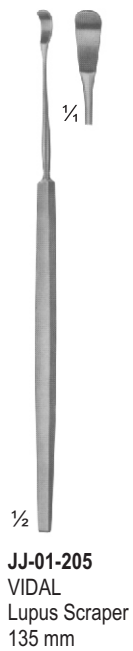
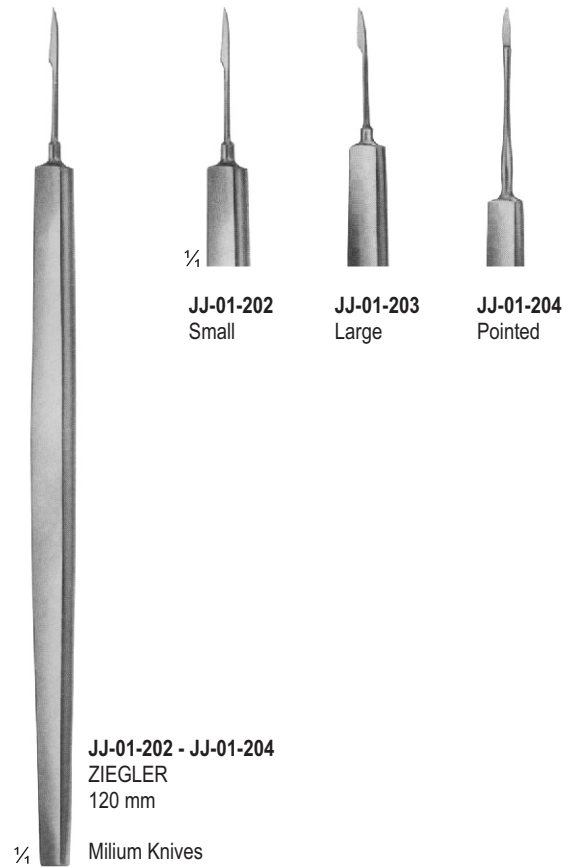
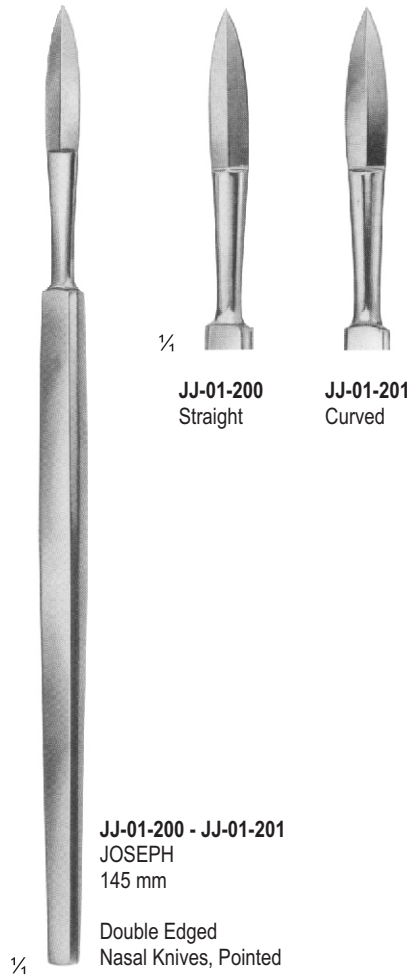

SCALPEL HANDLES



JJ-01-209
STANDARD
No. 4
Solid

JJ-01-210
Double Handle
No. 4 + No. 3
Solid

JJ-01-211
No. 4 L
Straight
Solid

JJ-01-212
No. 4 L
Solid Angled

JJ-01-213
COLLIN
No. 8
Hollow

JJ-01-214
COLLIN
No. 9
Hollow

JJ-01-215
Plastic

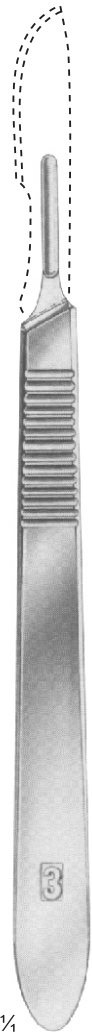

¼
JJ-01-216
STANDARD
No. 3
Solid



¼
JJ-01-217
No. 3
Solid



¼
JJ-01-218
No. 3
Solid



¼
JJ-01-219
No. 3 L
Straight
Solid

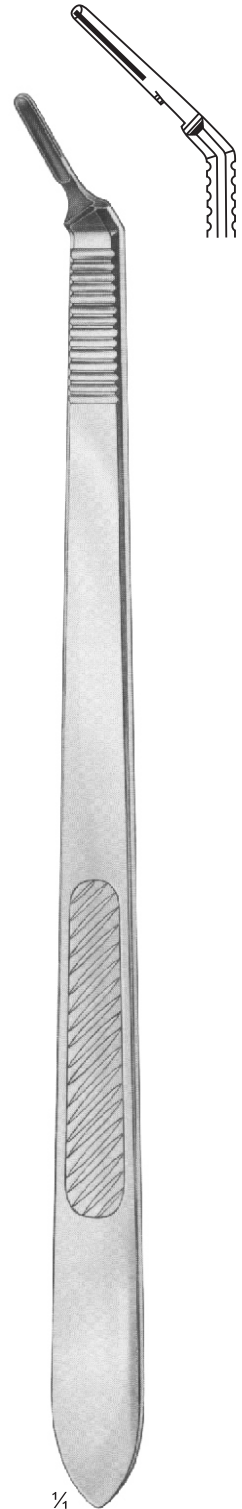

¼
JJ-01-220
No. 3 L
Angled
Solid

SCALPEL HANDLES



JJ-01-221
No. 7
Solid



JJ-01-222
No. 7 K
Solid



JJ-01-223
Hollow-Round



JJ-01-224
No. 3
Straight
Solid

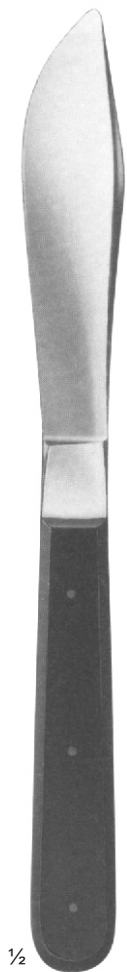

JJ-01-225
25.5 cm



JJ-01-226
VIRCHOW



JJ-01-227 - JJ-01-229
VIRCHOW

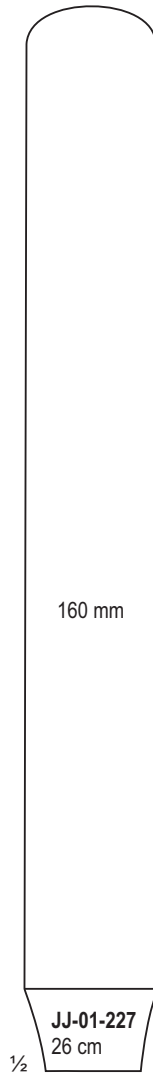

JJ-01-227
26 cm

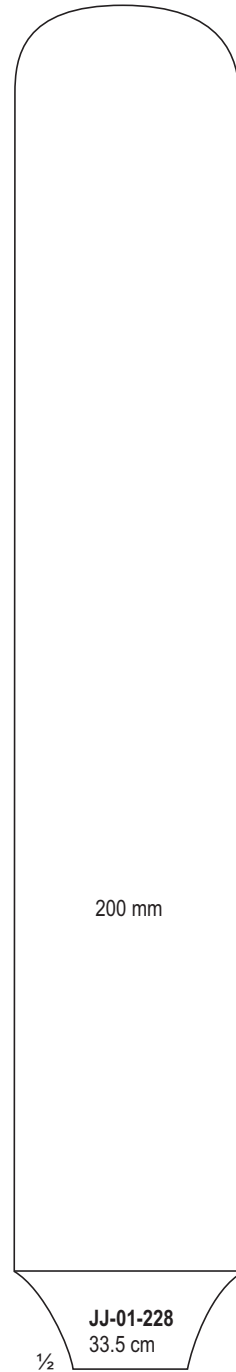

JJ-01-228
33.5 cm

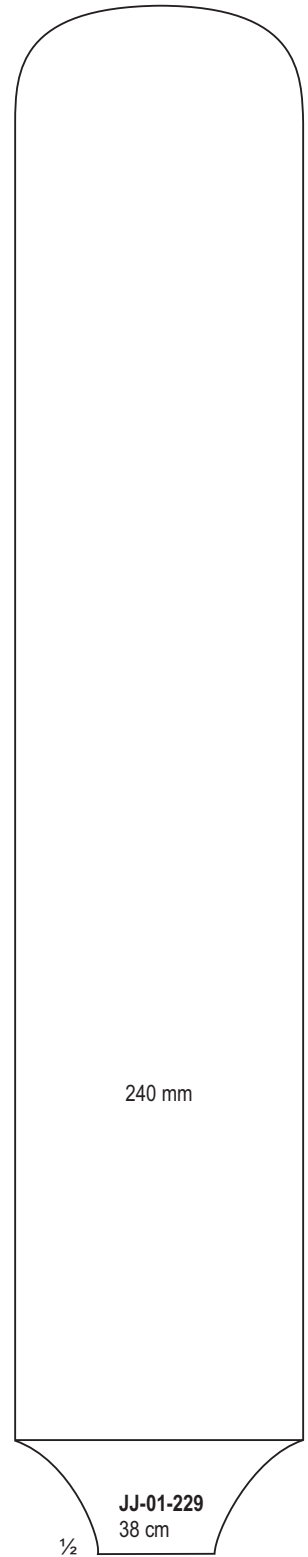

JJ-01-229
38 cm

RAZOR BLADE HOLDERS & BREAKERS



JJ-01-230
TROUTMAN-CHRIS
9 cm



JJ-01-231
TROUTMAN-CHRIS
9 cm

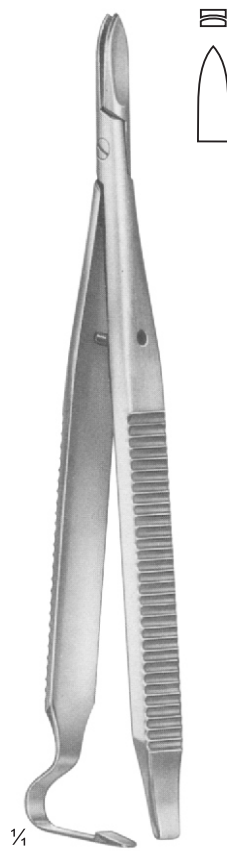

JJ-01-232
11 cm

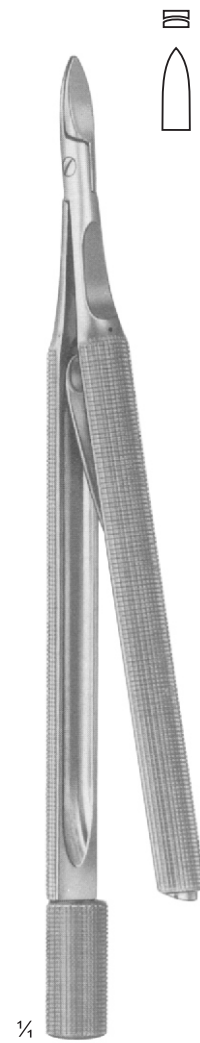

JJ-01-233
CASTROVIEJO
13 cm



JJ-01-234
18.5 cm



HUMBY
JJ-01-235
32 cm



HUMBY
JJ-01-235

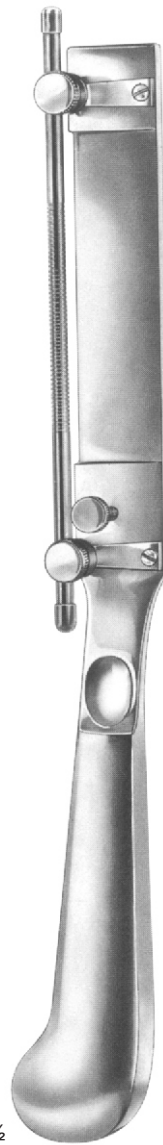

JJ-01-236
SCHINK
30 cm



SCHINK
JJ-01-236

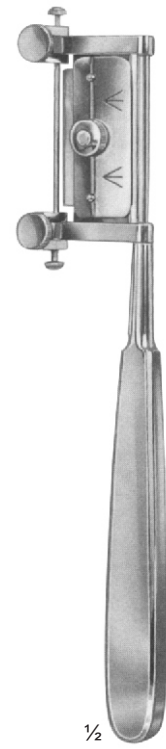

JJ-01-237
SILVER
19.5 cm



JJ-138
PARKER



JJ-139

9.5 cm

11 cm



JJ-140
COBBETT



JJ-141
BRAITHWATTE



Spare Blade



JJ-142
HUMBY
35 cm

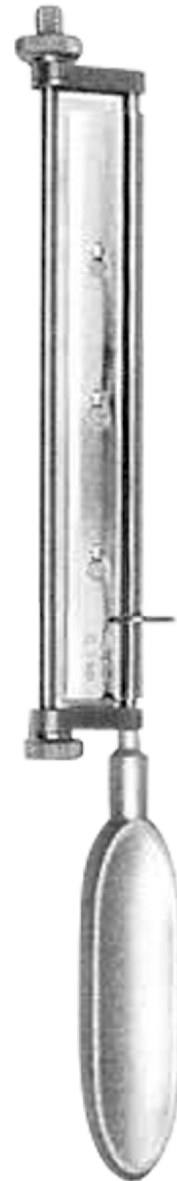

JJ-143
WATSON
30 cm

Page
22–70

- Scissors

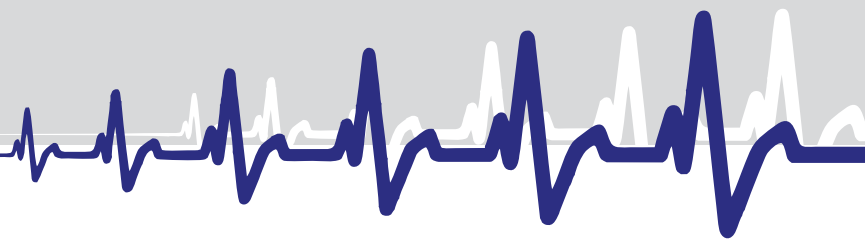

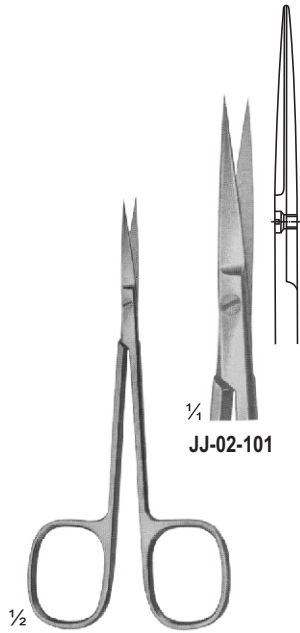

$\frac{1}{4}$
JJ-02-101

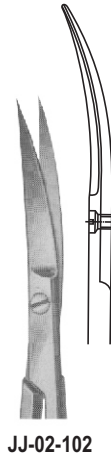

JJ-02-102

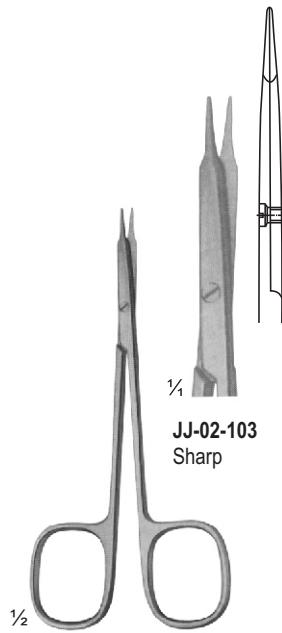

$\frac{1}{4}$
JJ-02-103
Sharp

$\frac{1}{2}$
JJ-02-103 - JJ-02-106
STEVENS
Dissecting Scissors
115 mm

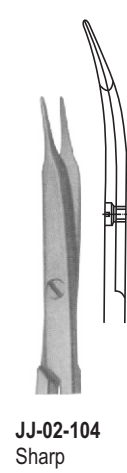

JJ-02-104
Sharp

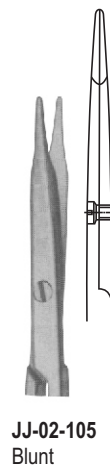

JJ-02-105
Blunt

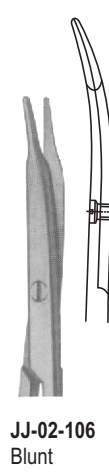

JJ-02-106
Blunt

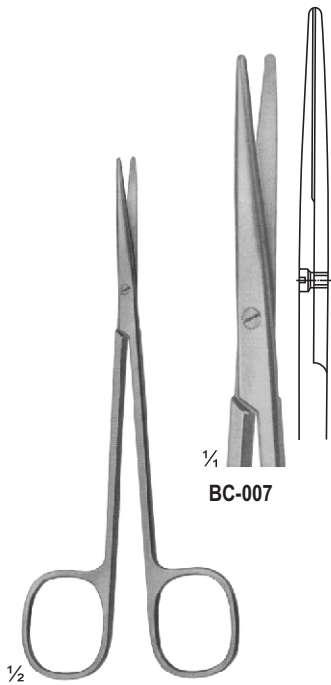

$\frac{1}{4}$
BC-007

$\frac{1}{2}$
JJ-02-107 - JJ-02-108
METZENBAUM
Dissecting Scissors
145 mm

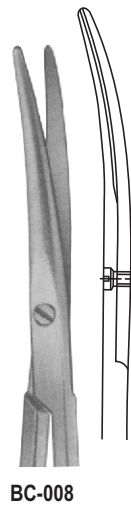

BC-008

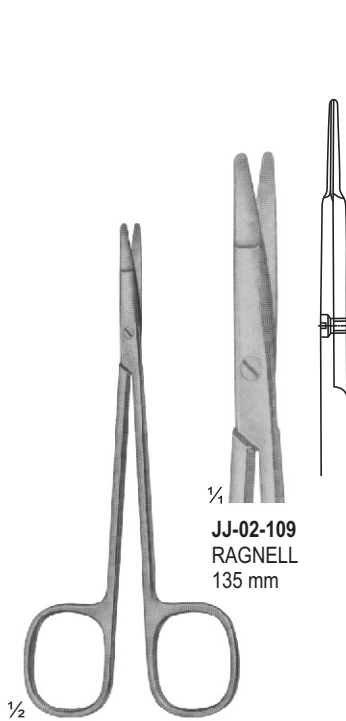

$\frac{1}{4}$
JJ-02-109
RAGNELL
135 mm

$\frac{1}{2}$
JJ-02-109 - JJ-02-111
Special flat points for
dissecting and
undermining the skin
145 mm

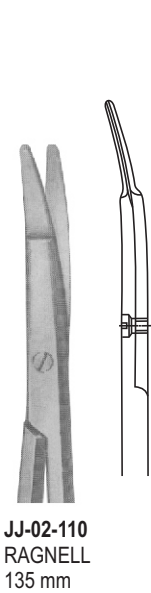

JJ-02-110
RAGNELL
135 mm

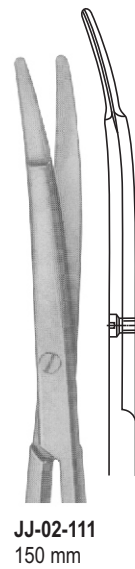

JJ-02-111
150 mm

DELICATE SCISSORS



KELLY
JJ-02-112
175 mm

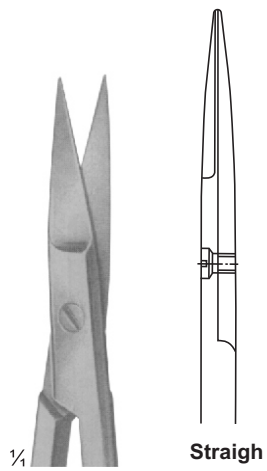

1/4
Straigh



KELLY
JJ-02-113
175 mm

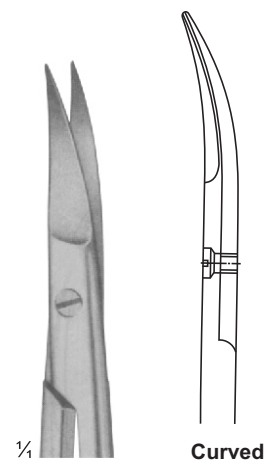

1/4
Curved



DOYEN
JJ-02-114
185 mm

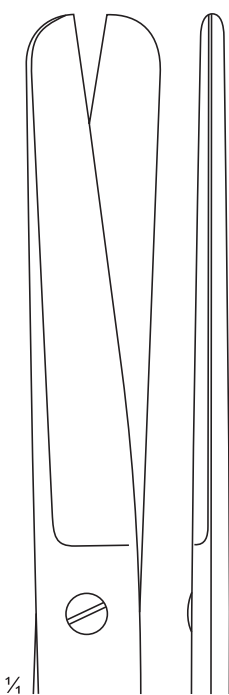

1/4



DOYEN
JJ-02-115
185 mm



1/4

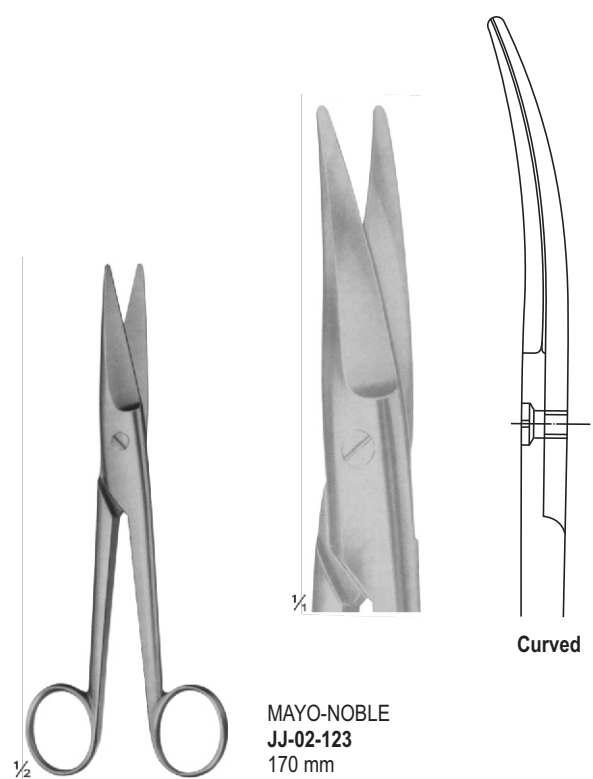
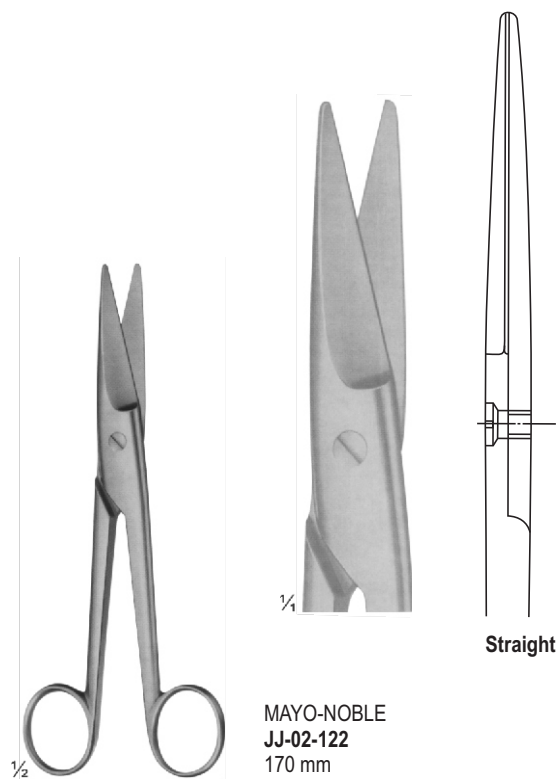
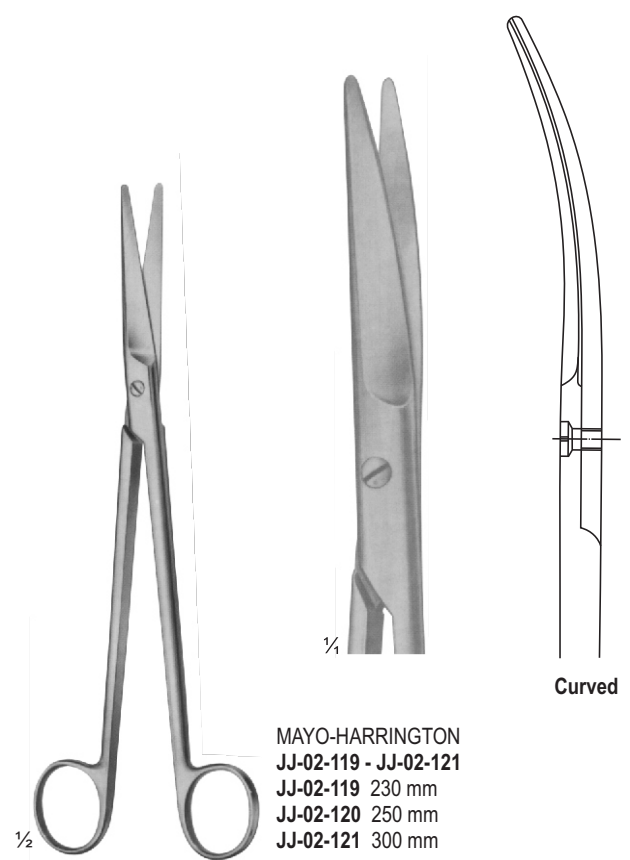
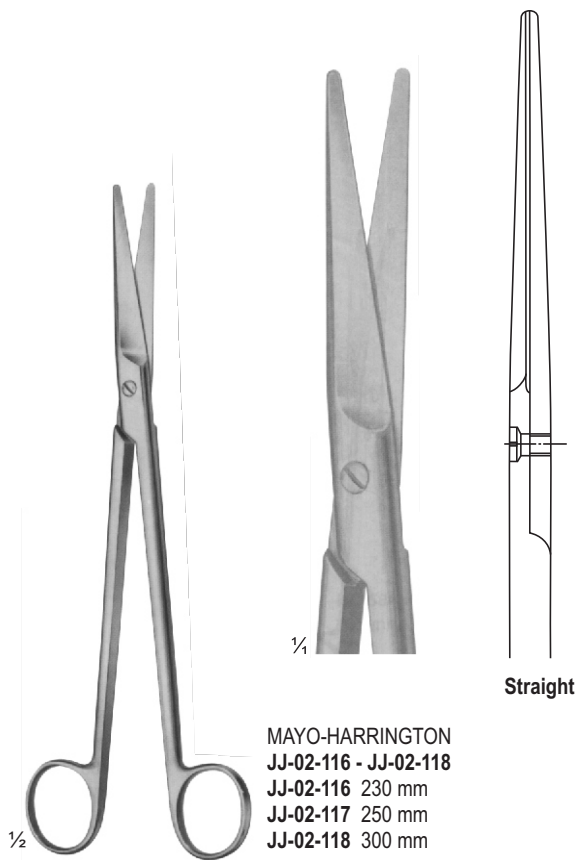

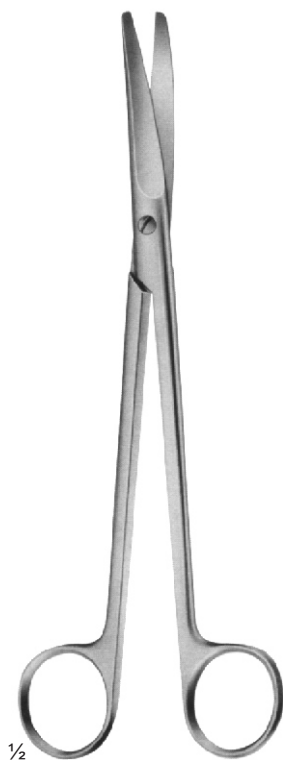

1/2

SIMS
JJ-02-124 - JJ-02-126
JJ-02-124 200 mm
JJ-02-125 210 mm
JJ-02-126 230 mm

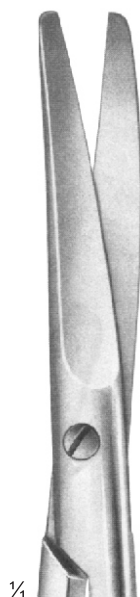

1/4



Curved



1/2

WERTHEIM
JJ-02-127 - JJ-02-129
JJ-02-127 145 mm
JJ-02-128 200 mm
JJ-02-129 230 mm

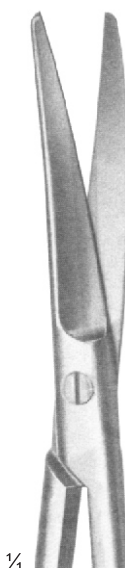

1/4



Curved

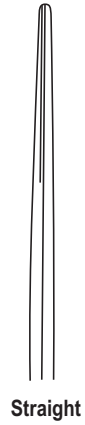
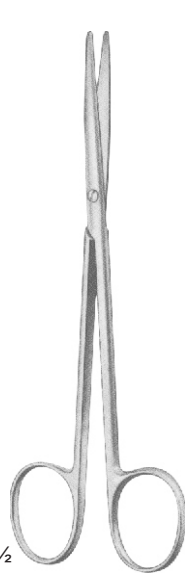

FINO-METZENBAUM
JJ-02-130 - JJ-02-135
 JJ-02-130 180 mm
 JJ-02-131 200 mm
 JJ-02-132 230 mm
 JJ-02-133 260 mm
 JJ-02-134 280 mm
 JJ-02-135 300 mm

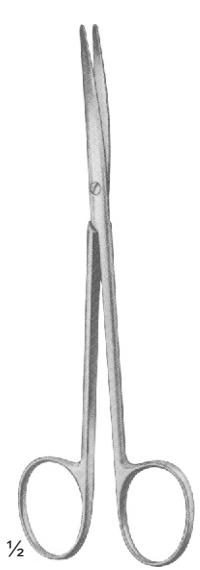

FINO-METZENBAUM
JJ-02-136 - JJ-02-141
 JJ-02-136 180 mm
 JJ-02-137 200 mm
 JJ-02-138 230 mm
 JJ-02-139 260 mm
 JJ-02-140 280 mm
 JJ-02-141 300 mm

VESSEL SCAISSORS

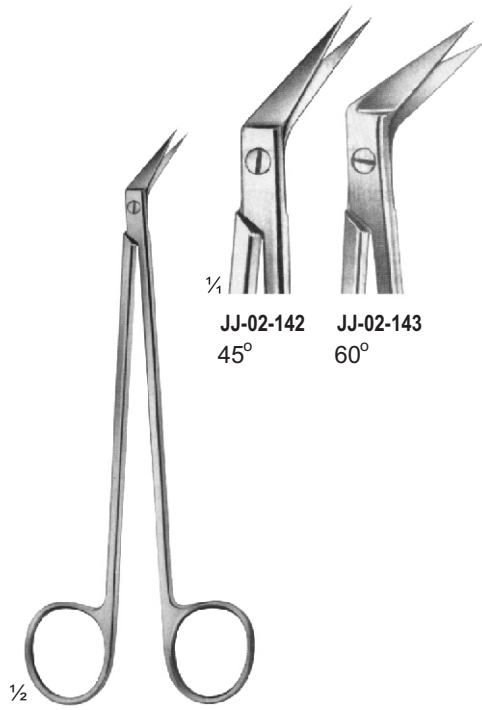

JJ-02-142
45°

JJ-02-143
60°

JJ-02-142 - JJ-02-143
DE BAKEY
155 mm

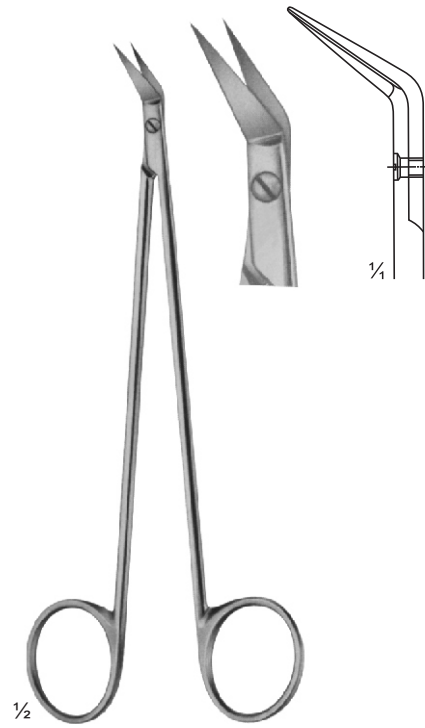

JJ-02-144
POTTS-SMITH
180 mm

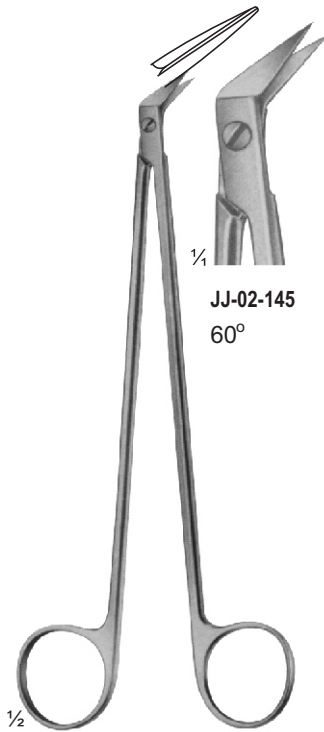

JJ-02-145
60°

JJ-02-145
POTTS-SMITH
180 mm

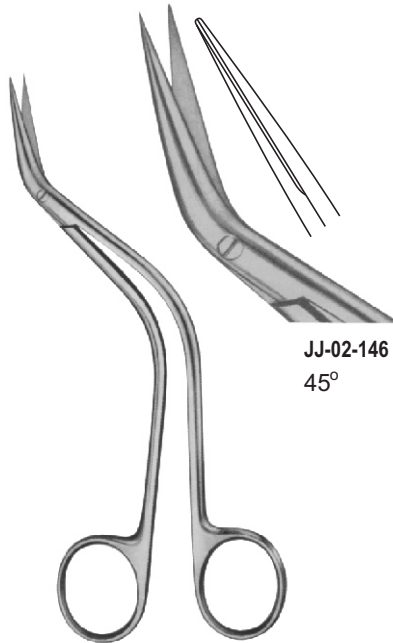

JJ-02-146
45°

JJ-02-146
DEBAKEY
155 mm

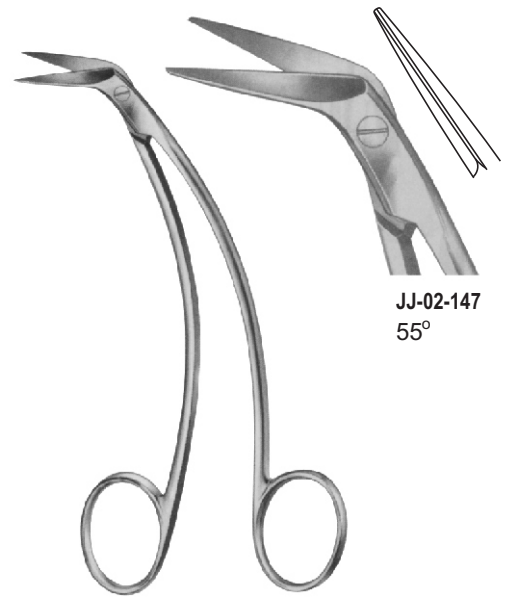

JJ-02-147
55°

JJ-02-147
FAVOLORO
140 mm

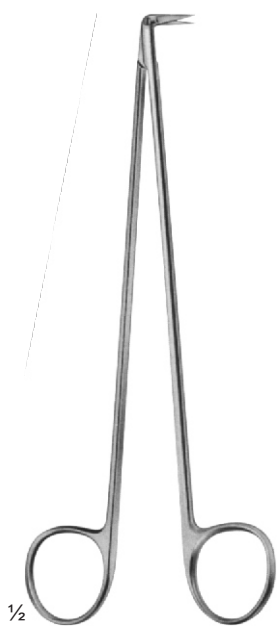

1/2

DIETHRICH
JJ-02-148 - JJ-02-152

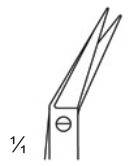

1/4
JJ-02-148
190 mm
25°



1/4
JJ-02-149
185 mm
45°



1/4
JJ-02-150
175 mm
60°

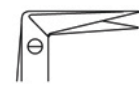

1/4
JJ-02-151
175 mm
90°



1/4
JJ-02-152
175 mm
120°

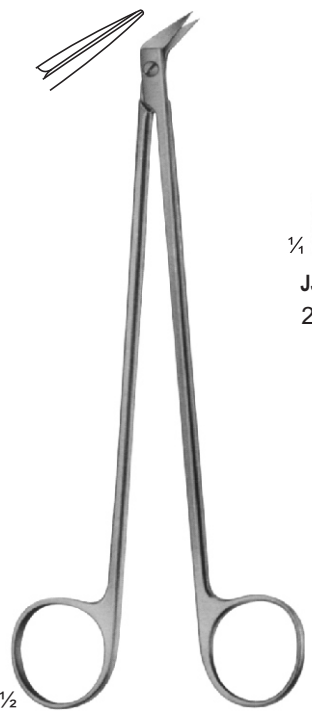

1/2

MIKRO-HEGEMANN
JJ-02-153 - JJ-02-157
185 mm



1/4
JJ-02-153
25°



1/4
JJ-02-154
45°



1/4
JJ-02-155
60°

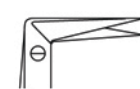

1/4
JJ-02-156
90°



1/4
JJ-02-157
120°

DELICATE SCISSORS

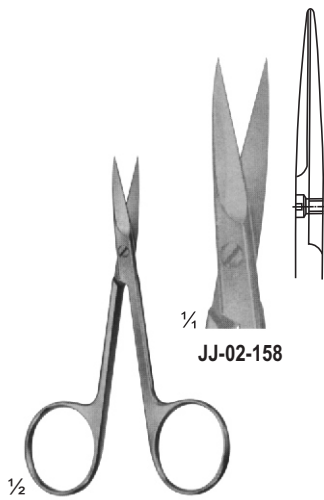

JJ-02-158

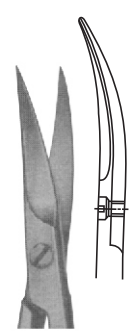

JJ-02-159

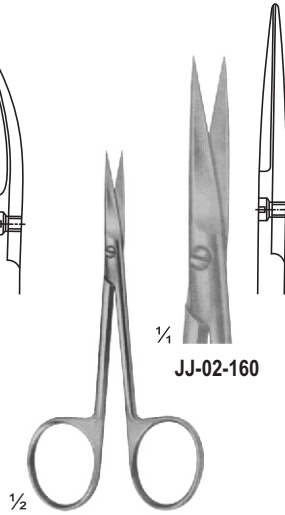

JJ-02-160

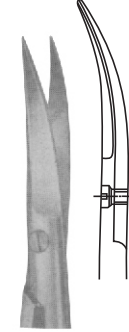

JJ-02-161

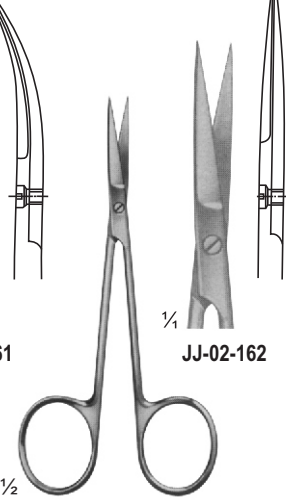

JJ-02-162

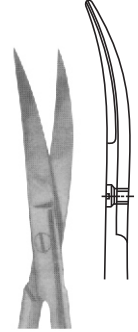

JJ-02-163

JJ-02-158 - JJ-02-159
Cutical
90 mm

JJ-02-160 - JJ-02-161
95 mm

JJ-02-162 - JJ-02-163
Iris
100 mm

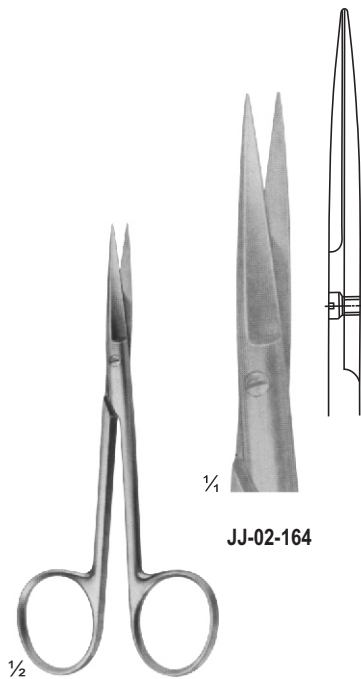

JJ-02-164

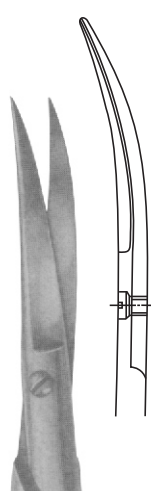

JJ-02-165

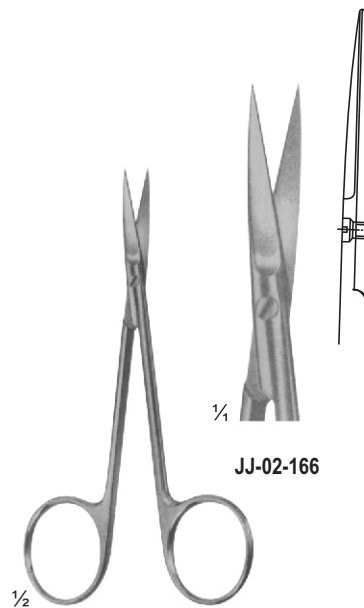

JJ-02-166

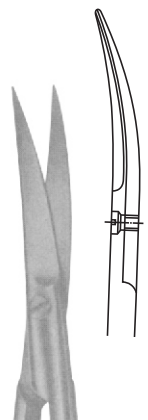

JJ-02-167

JJ-02-164 - JJ-02-165
Wagner
130 mm

JJ-02-166 - JJ-02-167
Iris
110 mm



JJ-02-168 - JJ-02-170
Fine Operating Scissors
120 mm

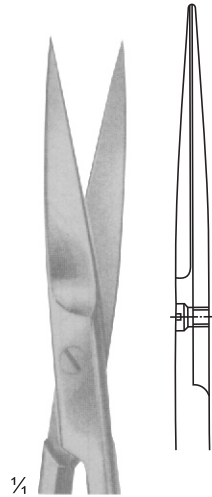

JJ-02-168

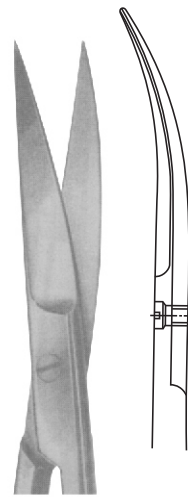

JJ-02-169

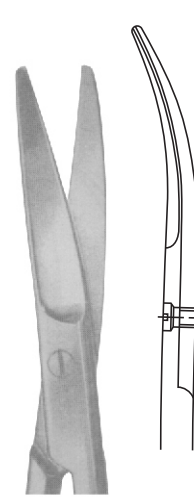

JJ-02-170



JJ-02-171 - JJ-02-174
Fine Operating Scissors
130 mm

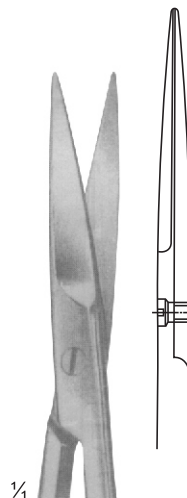

JJ-02-171

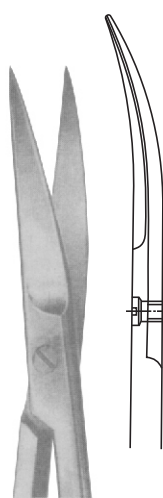

JJ-02-172

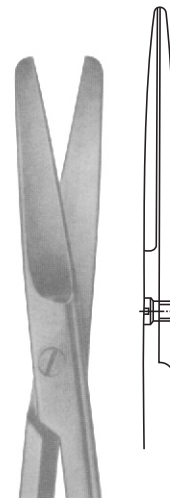

JJ-02-173

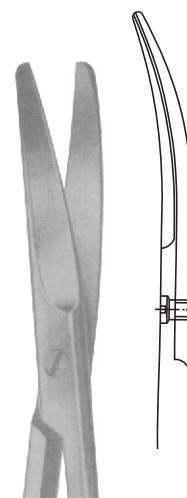

JJ-02-174

DELICATE SCISSORS

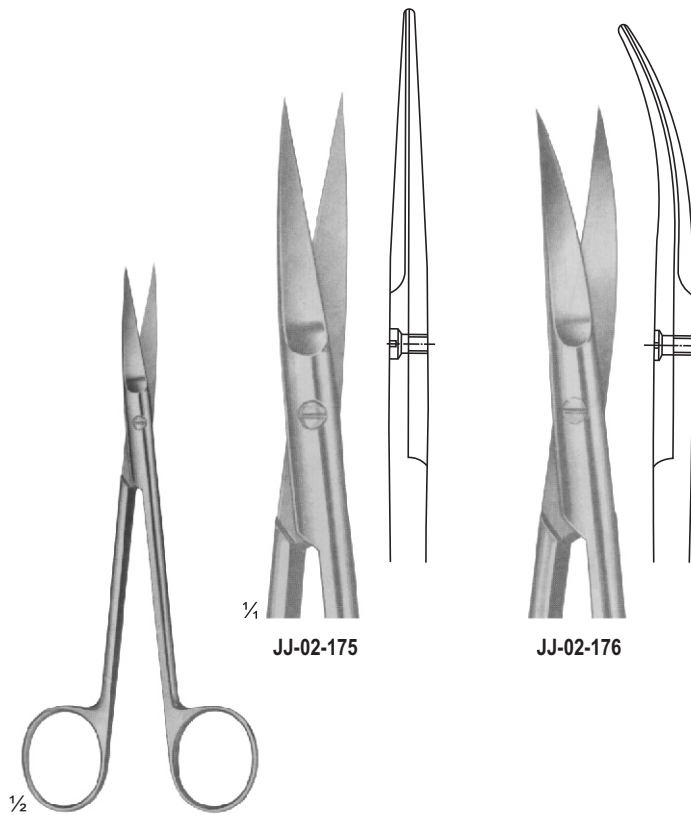

JJ-02-175

JJ-02-176

JJ-02-175 - JJ-02-176
JOSEPH
150 mm

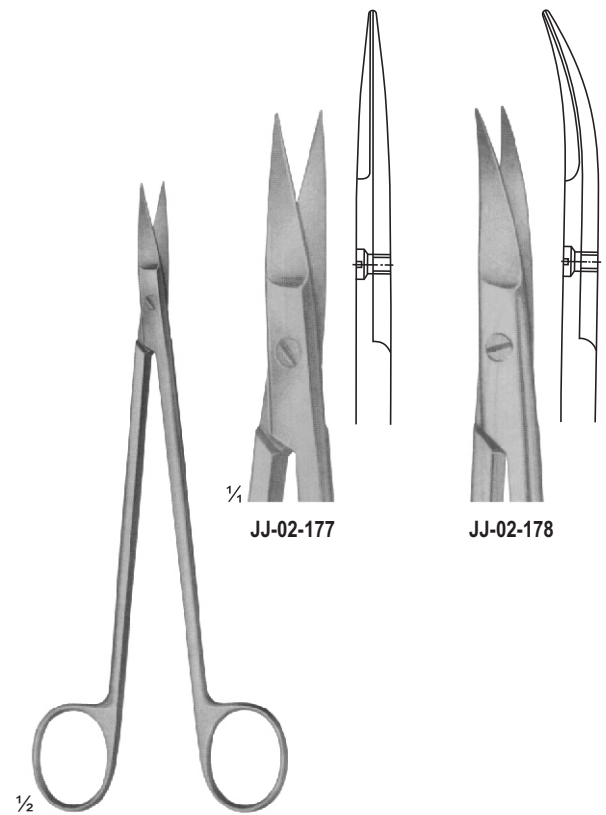

JJ-02-177

JJ-02-178

JJ-02-177 - JJ-02-178
KELLY
175 mm

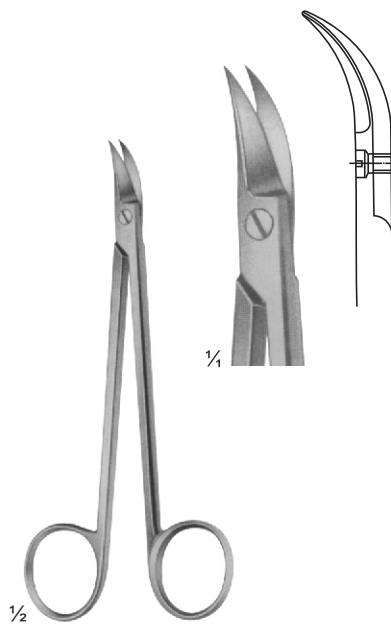

JJ-02-179
QUINBY
130 mm

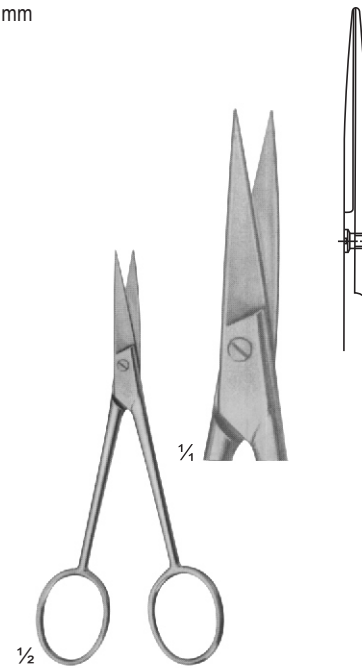

JJ-02-180
Dissecting
110 mm

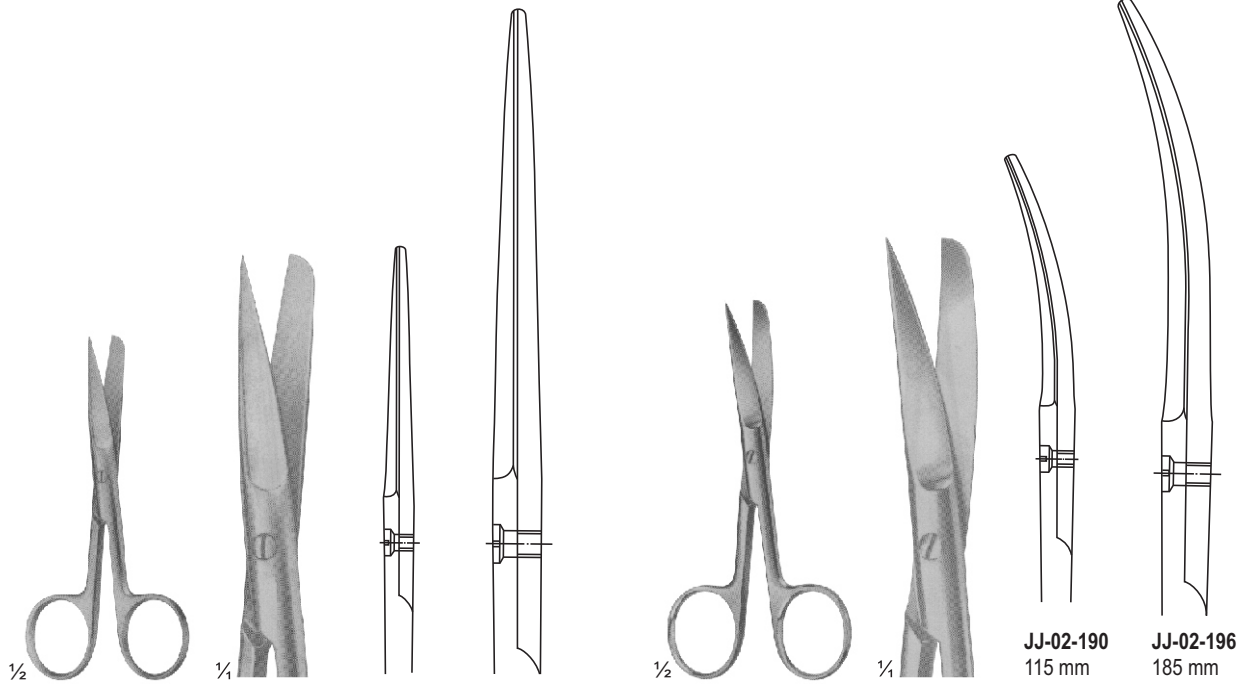

JJ-02-181 - JJ-02-189 (Standard Types)

- JJ-02-181 (105 mm)
- JJ-02-182 (115 mm)
- JJ-02-183 (130 mm)
- JJ-02-184 (145 mm)
- JJ-02-185 (150 mm)
- JJ-02-186 (165 mm)
- JJ-02-187 (175 mm)
- JJ-02-188 (185 mm)
- JJ-02-189 (200 mm)

- JJ-02-181**
105 mm
- JJ-02-189**
200 mm

JJ-02-190 - JJ-02-195 (Standard Types)

- JJ-02-190 (115 mm)
- JJ-02-191 (130 mm)
- JJ-02-192 (145 mm)
- JJ-02-193 (150 mm)
- JJ-02-194 (165 mm)
- JJ-02-195 (175 mm)
- JJ-02-196 (185 mm)

- JJ-02-190**
115 mm
- JJ-02-196**
185 mm

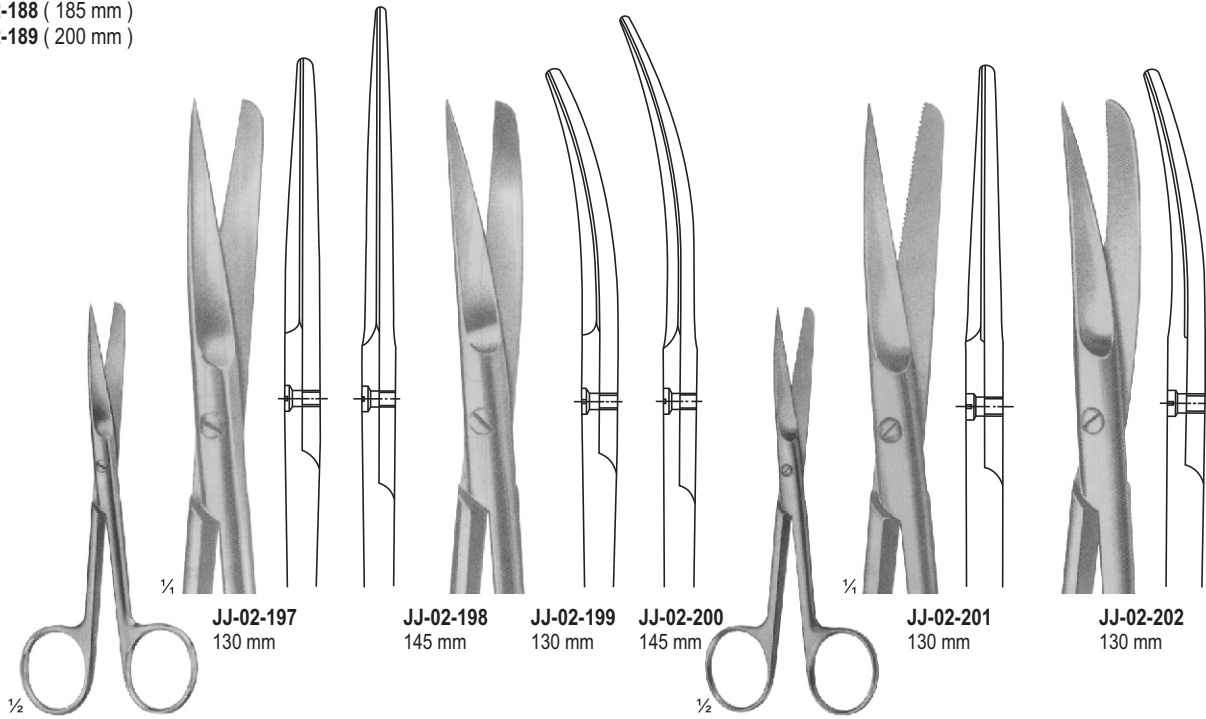

JJ-02-197 - JJ-02-200
Slender Types

- JJ-02-197**
130 mm
- JJ-02-198**
145 mm
- JJ-02-199**
130 mm
- JJ-02-200**
145 mm

JJ-02-201 - JJ-02-202
For Wound Edges
1 Blade Serrated

- JJ-02-201**
130 mm
- JJ-02-202**
130 mm

SURGICAL SCISSORS

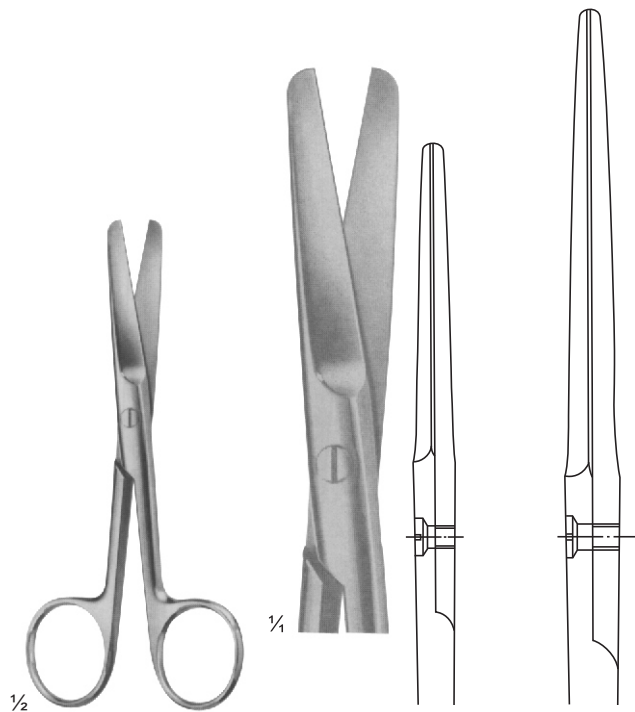

JJ-02-203 - JJ-02-207 (Standard Types)
JJ-02-203 (130 mm)
JJ-02-204 (145 mm)
JJ-02-205 (150 mm)
JJ-02-206 (165 mm)
JJ-02-207 (175 mm)

JJ-02-203
 130 mm

JJ-02-207
 175 mm

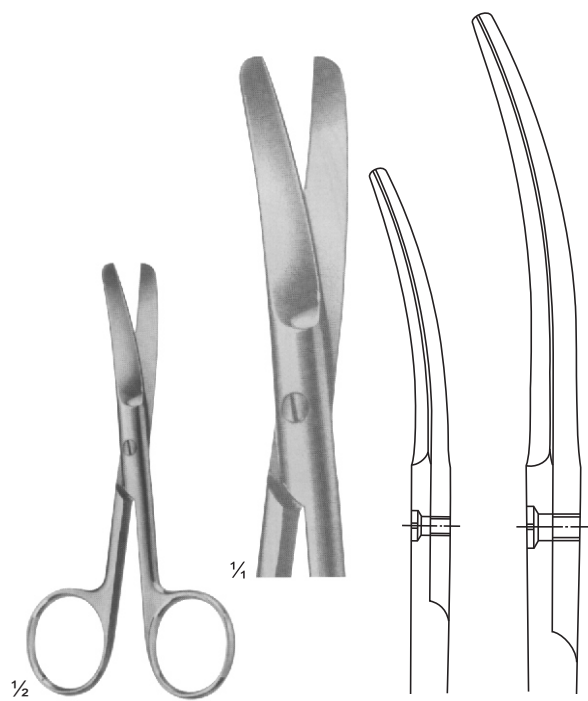

JJ-02-208 - JJ-02-213 - COOPER
 Standard Types
JJ-02-208 (115 mm)
JJ-02-209 (130 mm)
JJ-02-210 (145 mm)
JJ-02-211 (150 mm)
JJ-02-212 (165 mm)
JJ-02-213 (175 mm)

JJ-02-208
 115 mm

JJ-02-213
 175 mm

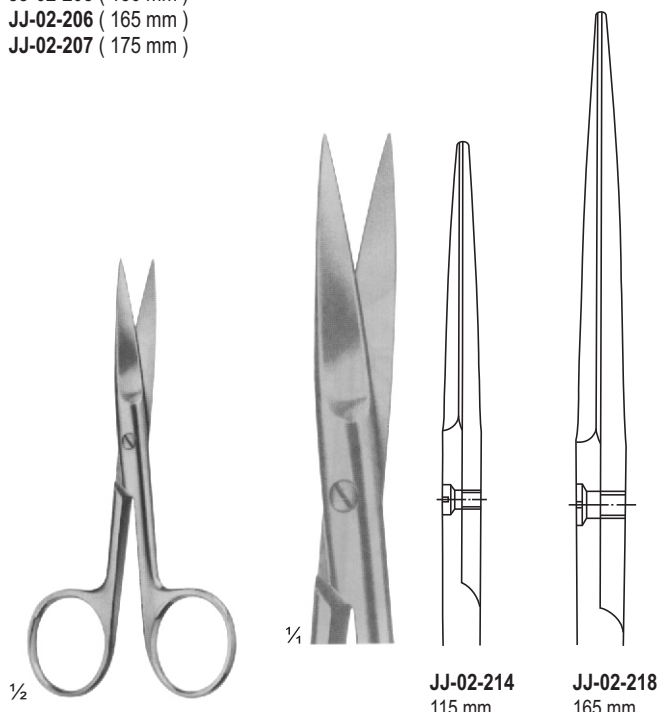

JJ-02-214 - JJ-02-218
 Standard Types
JJ-02-214 (115 mm)
JJ-02-215 (130 mm)
JJ-02-216 (145 mm)
JJ-02-217 (150 mm)
JJ-02-218 (165 mm)

JJ-02-214
 115 mm

JJ-02-218
 165 mm

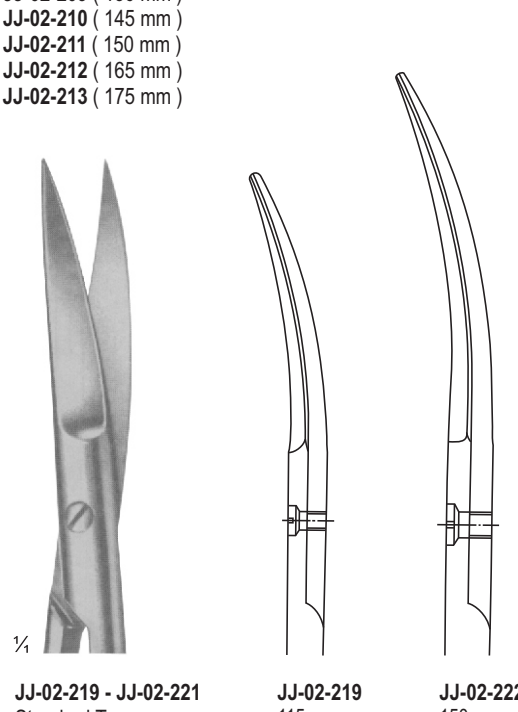

JJ-02-219 - JJ-02-221
 Standard Types
JJ-02-219 (115 mm)
JJ-02-220 (130 mm)
JJ-02-221 (145 mm)
JJ-02-222 (150 mm)

JJ-02-219
 115 mm

JJ-02-222
 150 mm

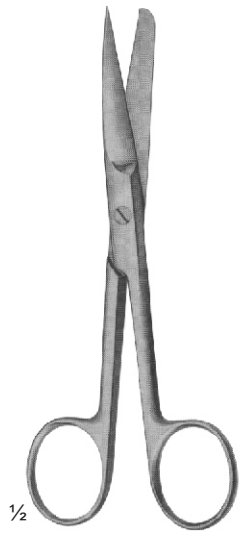

JJ-02-223 - JJ-02-225
DEAVER
With flat lock

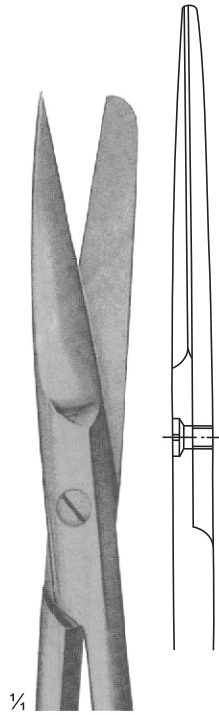

JJ-02-223
145 mm

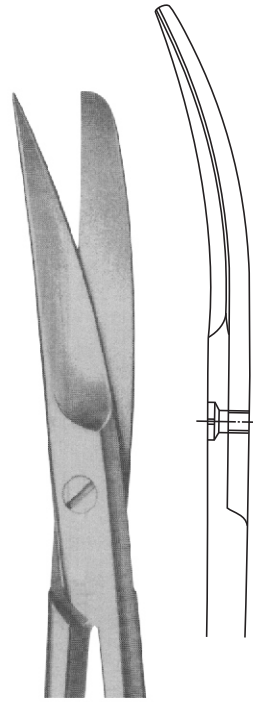

JJ-02-224
145 mm

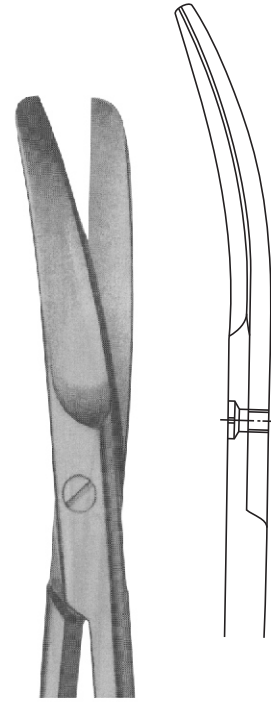

JJ-02-225
145 mm

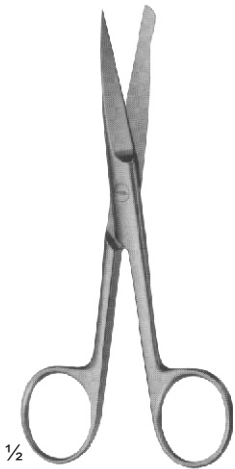

JJ-02-226 - JJ-02-228
Incision Scissors

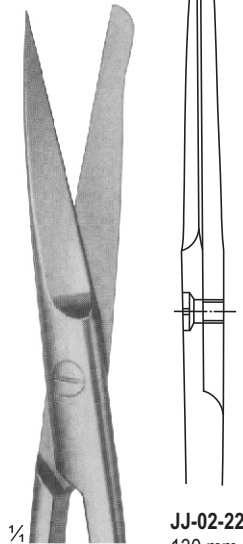

JJ-02-226
130 mm

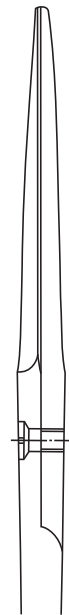

JJ-02-227
145 mm

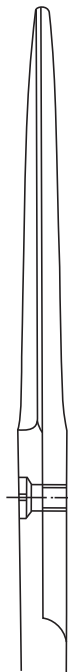

JJ-02-228
165 mm

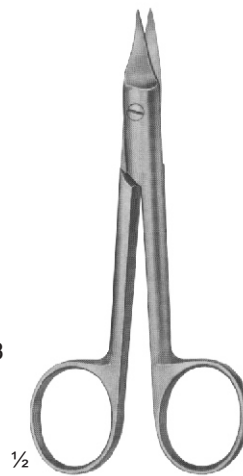

JJ-02-229
SYSTRUNK
Nail Splitting Scissors

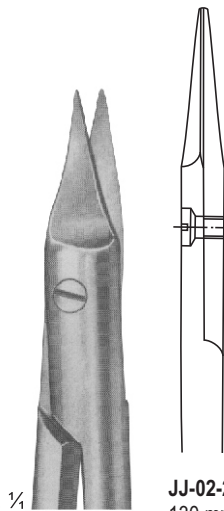

JJ-02-229
130 mm

DISSECTING SCISSORS

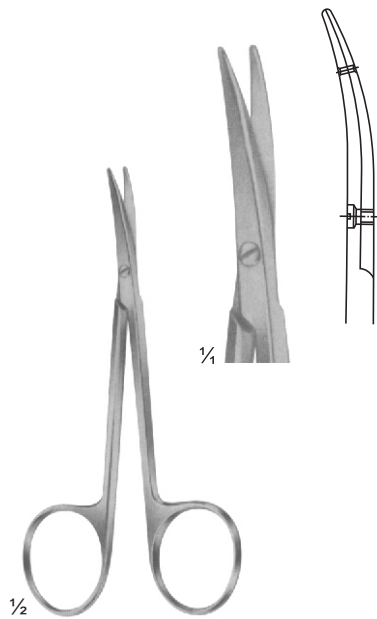

JJ-02-230
LITTLER
Dissecting Scissors
Tips with eye for suture
115 mm

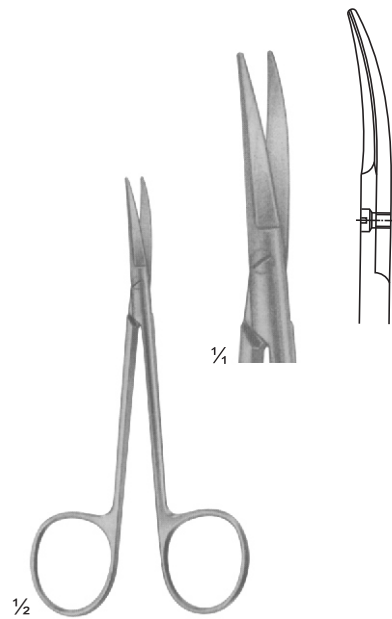

JJ-02-231
COTTLE
Bulldog Scissors
115 mm



JJ-02-232
Size: 100 mm

JJ-02-233
Size: 100 mm

JJ-02-232 - JJ-02-233
STEVENS
Vessel and tendon Scissors
100 mm

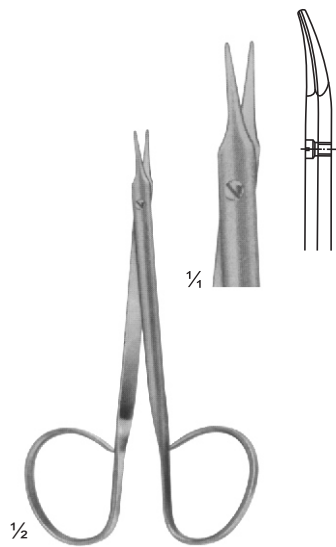

JJ-02-234
STEVENS
Fine Dissecting Scissors
110 mm

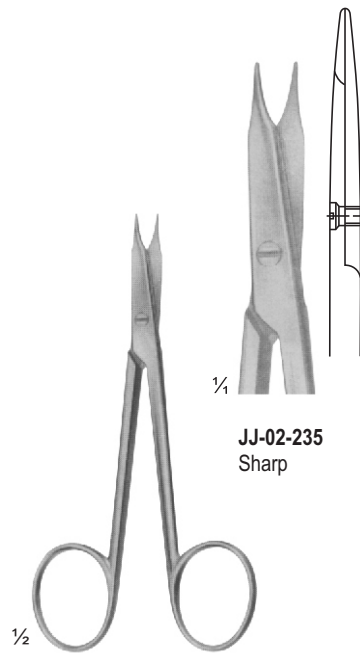

JJ-02-235 - JJ-02-238
STEVENS
Vessel and tendon Scissors
110 mm

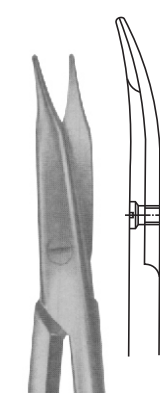

JJ-02-236
Sharp

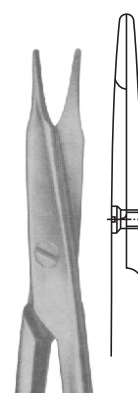

JJ-02-237
Blunt

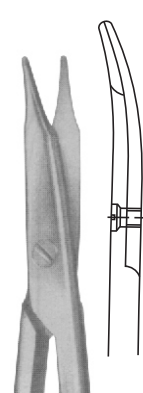

JJ-02-238
Blunt

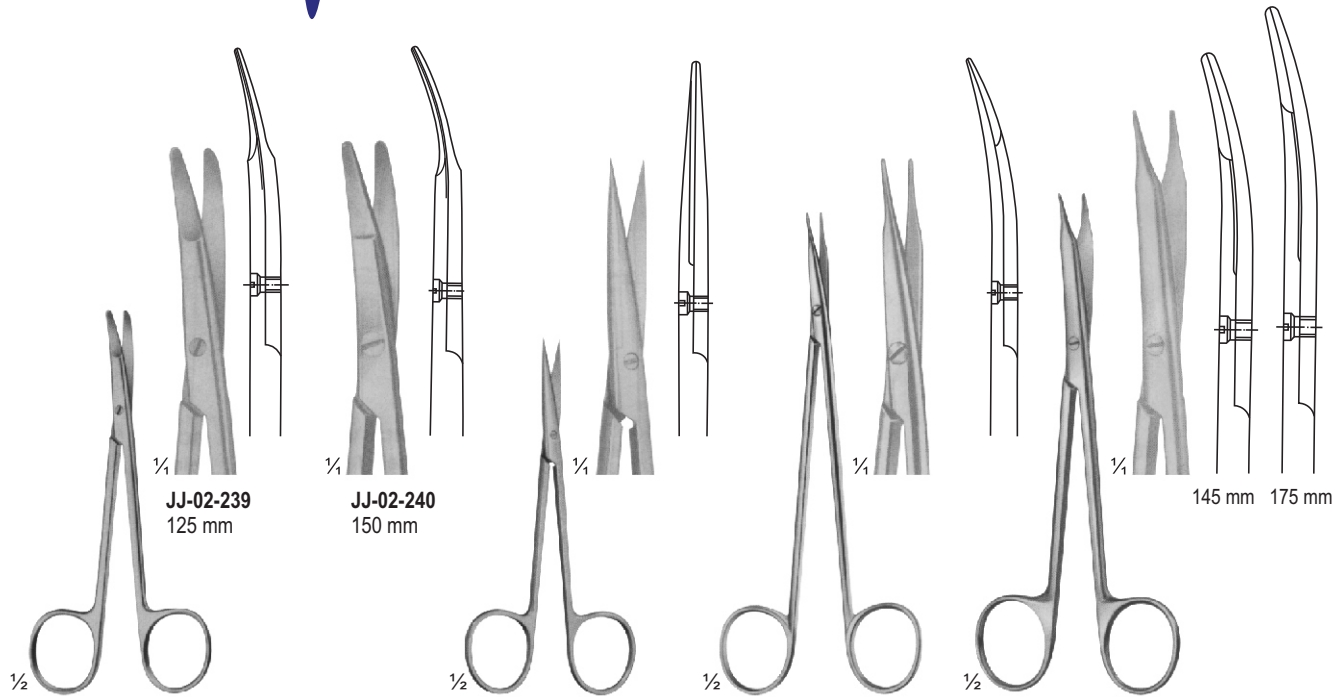

JJ-02-239 - JJ-02-240
KILNER
Special flat points for dissecting and undermining the skin

JJ-02-241
KILNER
Fine dissecting scissors
115 mm

JJ-02-242
JAMESON
Dissecting scissors
150 mm

JJ-02-243
REYNOLDS
Dissecting scissors
145 - 175 mm

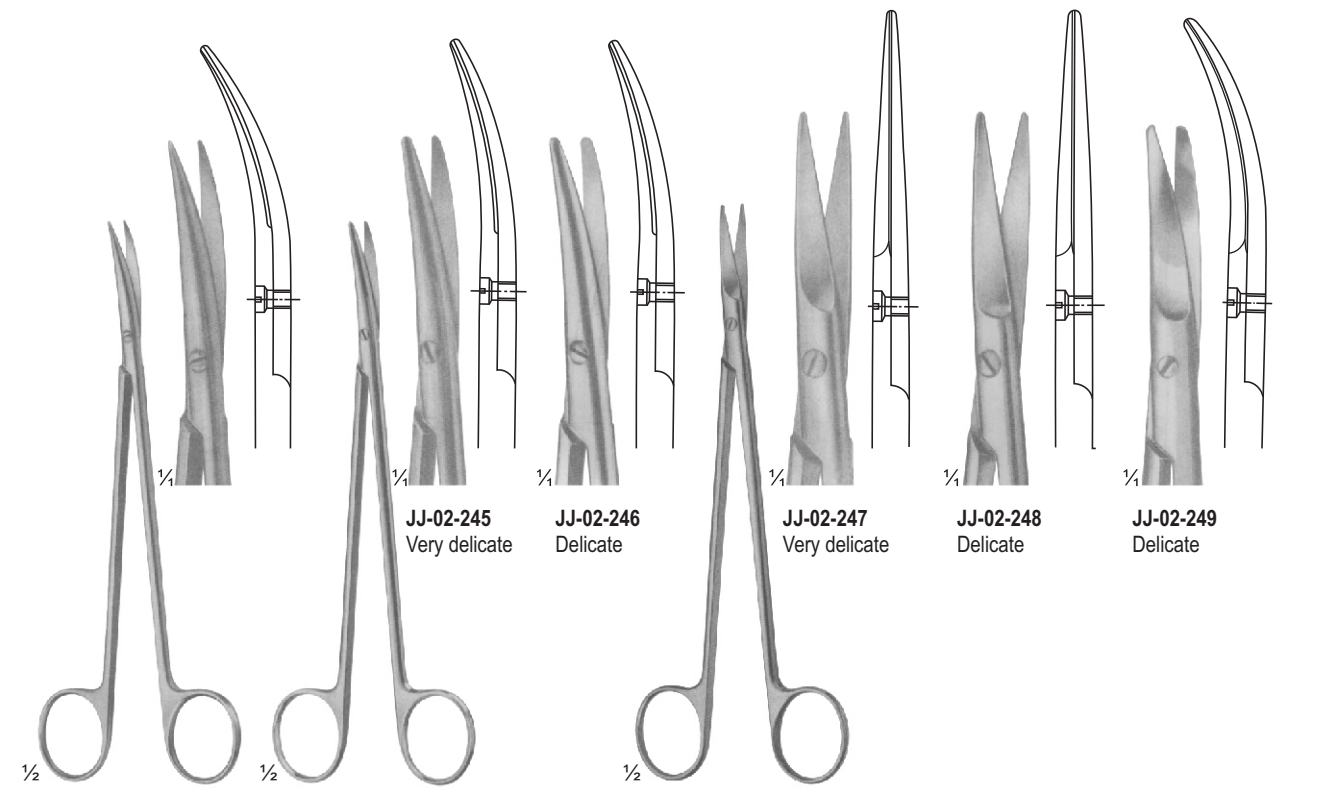

JJ-02-244
DE BAKEY
Ateriotomy scissors
175 mm

JJ-02-245 - JJ-02-246
TOENNIS ADSON
Dissecting scissors
175 mm

JJ-02-247 - JJ-02-249
TOENNIS
Dissecting scissors
150 mm

JJ-02-245
Very delicate

JJ-02-246
Delicate

JJ-02-247
Very delicate

JJ-02-248
Delicate

JJ-02-249
Delicate

DISSECTING & SURGICAL SCISSORS

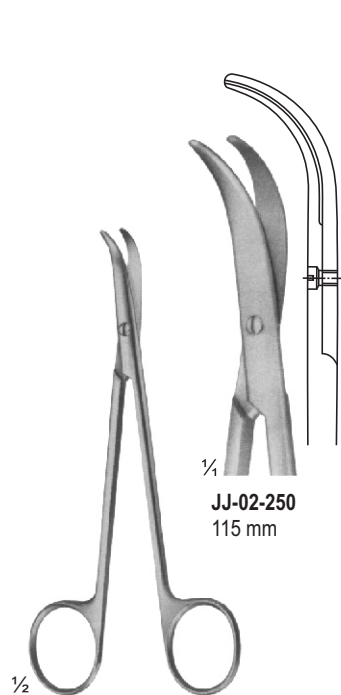

JJ-02-250
115 mm

JJ-02-250 - JJ-02-251
FOMON
Lower lateral scissors

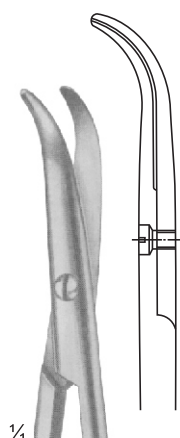

JJ-02-251
135 mm



JJ-02-252

JJ-02-252 - JJ-02-253
LANDOLT
Enucleation scissors
120 mm

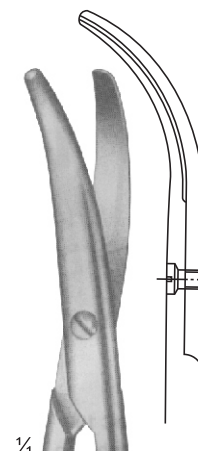

JJ-02-253

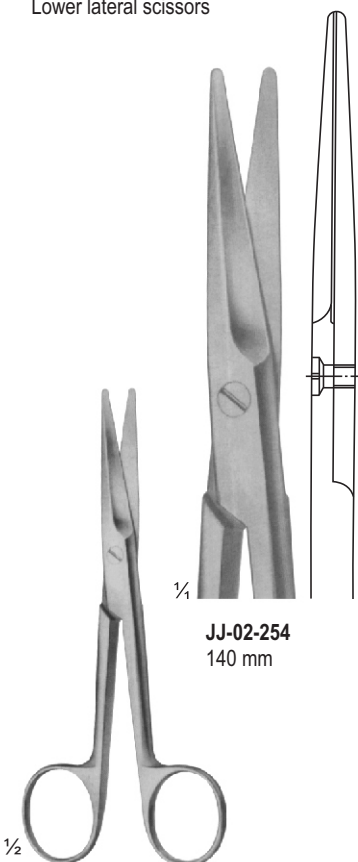

JJ-02-254
140 mm

JJ-02-254 - JJ-02-256
MAYO
JJ-02-254 (140 mm)
JJ-02-255 (155 mm)
JJ-02-256 (170 mm)

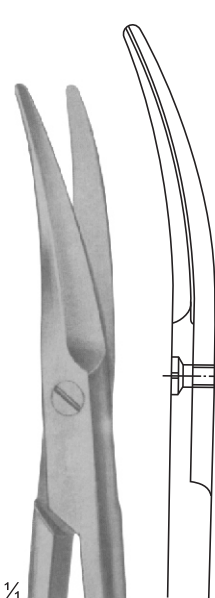

JJ-02-257 - JJ-02-259
MAYO
JJ-02-257 (140 mm)
JJ-02-258 (155 mm)
JJ-02-259 (170 mm)

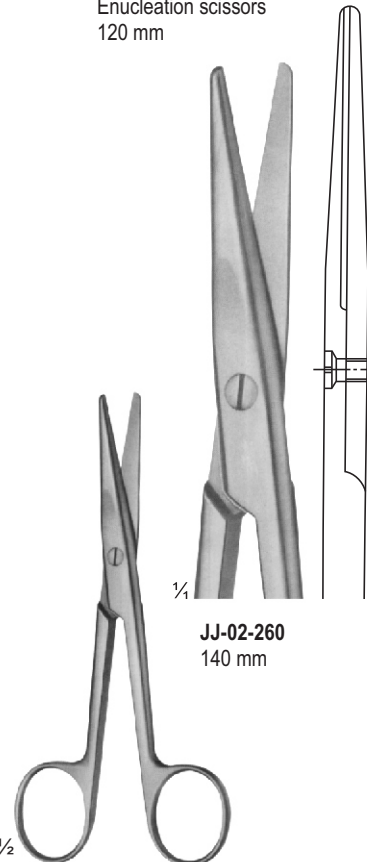

JJ-02-260
140 mm

JJ-02-260 - JJ-02-262
MAYO-STILLE
JJ-02-261 (140 mm)
JJ-02-262 (170 mm)

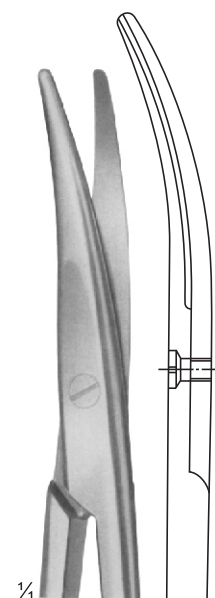

JJ-02-263 - JJ-02-264
MAYO-STILLE
JJ-02-263 (140 mm)
JJ-02-264 (170 mm)

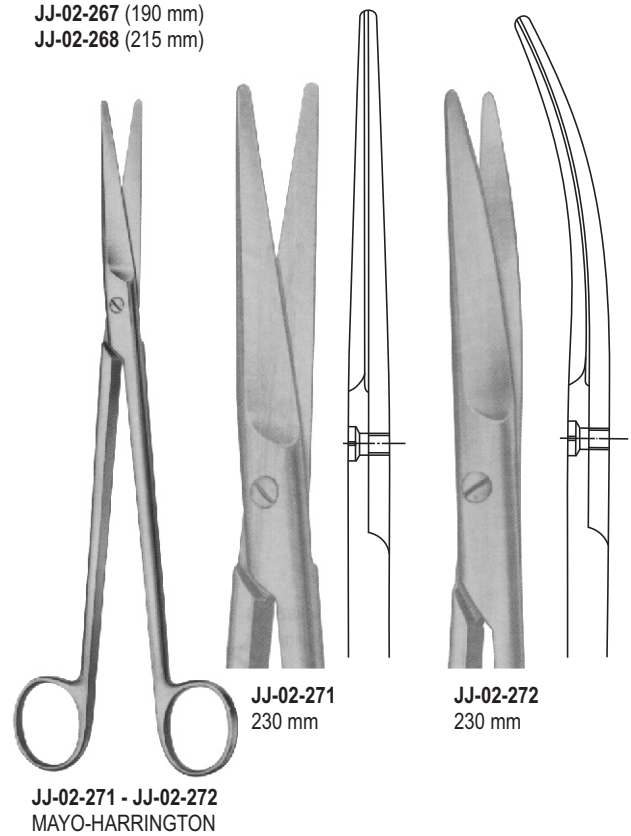
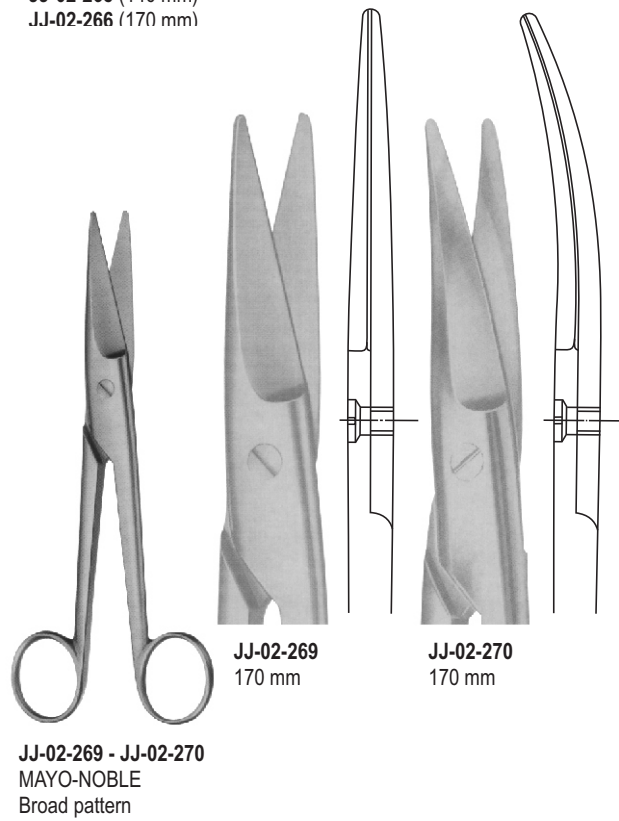
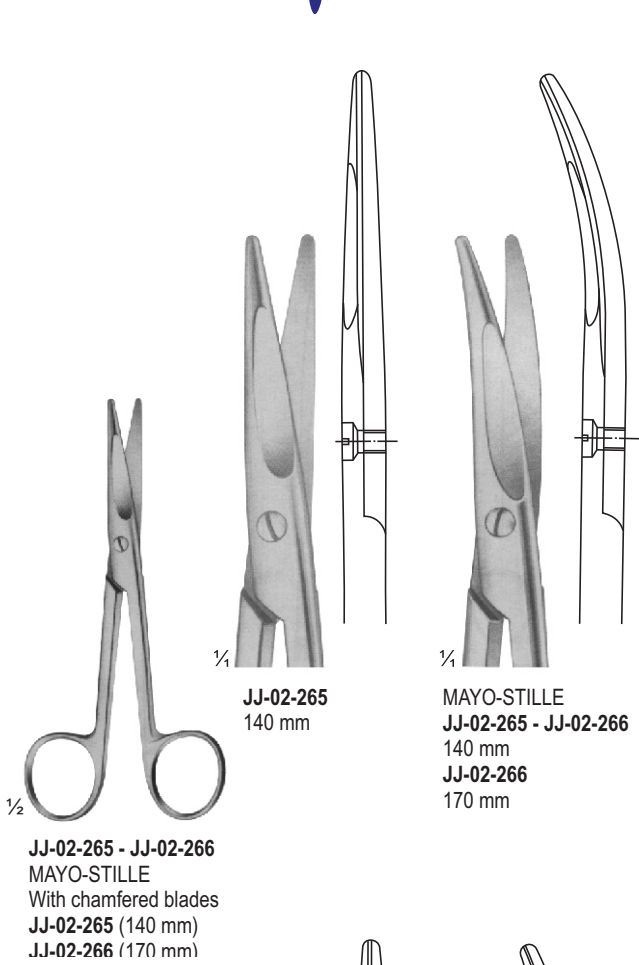

DISSECTING SCISSORS

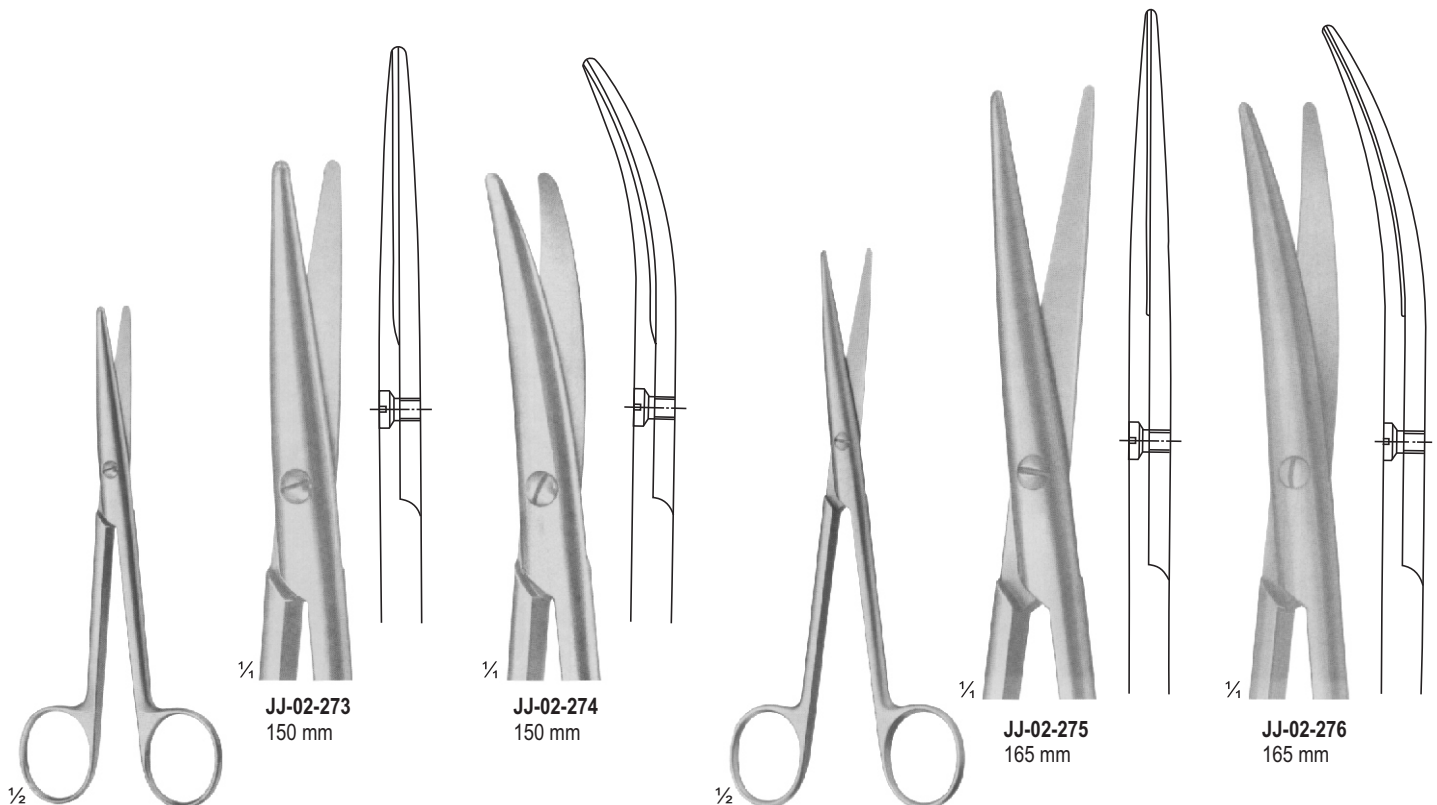

JJ-02-273 - JJ-02-274
STILLE
150 mm

JJ-02-275 - JJ-02-276
LEXER
Narrow
165 mm

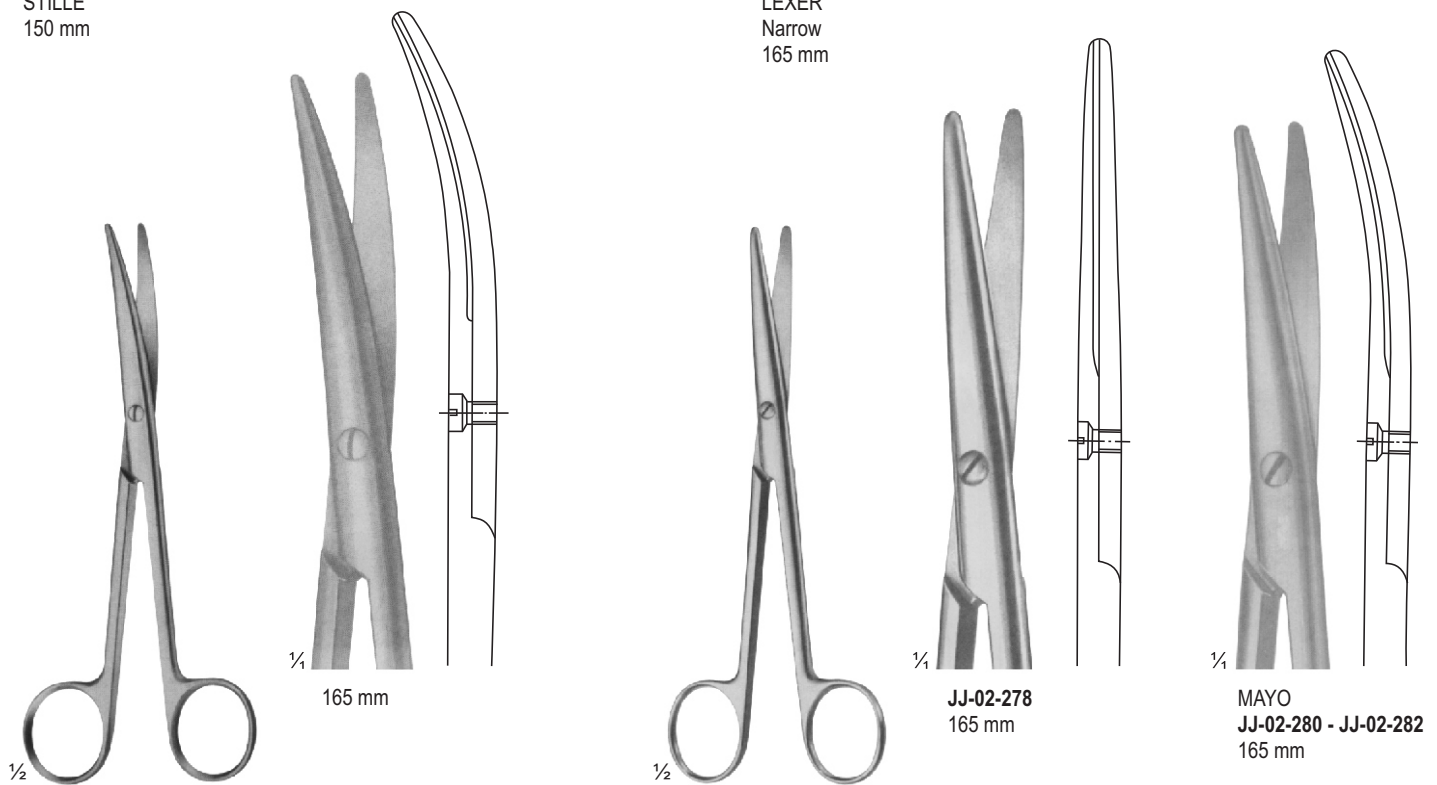

JJ-02-277
MAYO-LEXER
Standard

JJ-02-278 - JJ-02-279
MAYO
JJ-02-278 (165 mm)
JJ-02-279 (200 mm)

MAYO
JJ-02-280 - JJ-02-282
165 mm
JJ-02-281
200 mm
JJ-02-282
210 mm

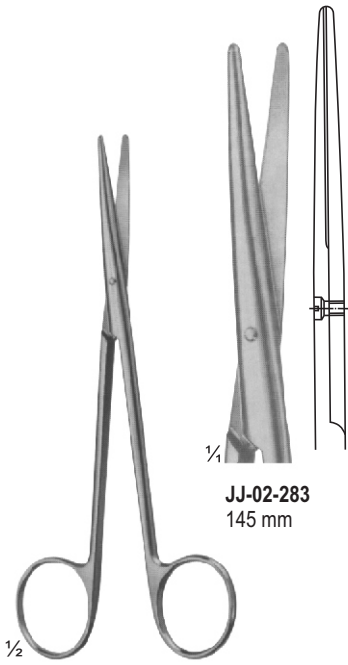

JJ-02-283
145 mm

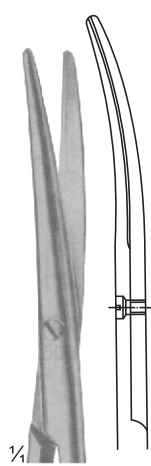

JJ-02-284
145 mm

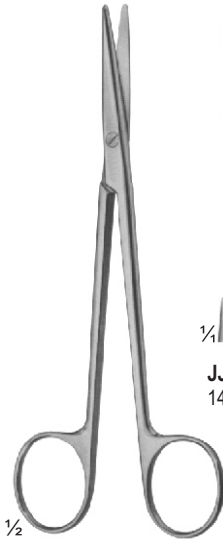

JJ-02-285
145 mm

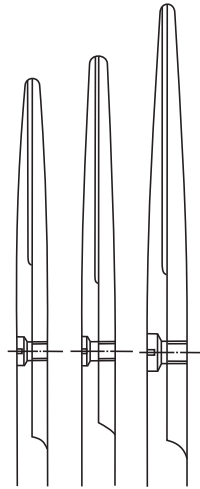

JJ-02-286
180 mm

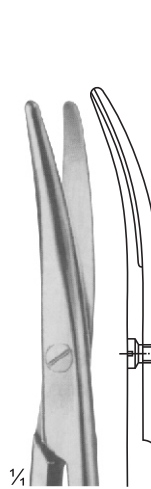

JJ-02-287
200 mm



JJ-02-288
145 mm

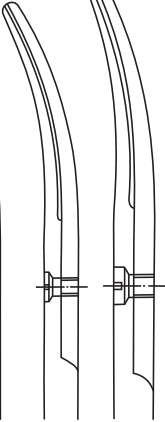

JJ-02-289
180 mm



JJ-02-290
200 mm

JJ-02-283 - JJ-02-284
BABY - METZENBAUM

JJ-02-285 - JJ-02-290
METZENBAUM

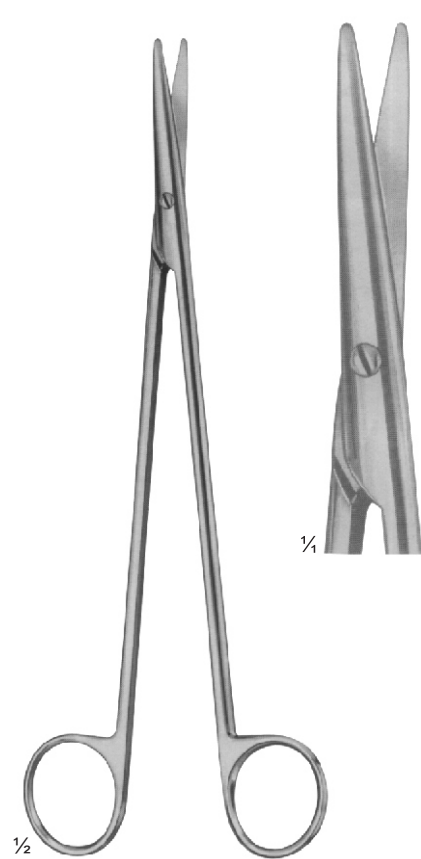

JJ-02-291 - JJ-02-298
NELSON - METZENBAUM

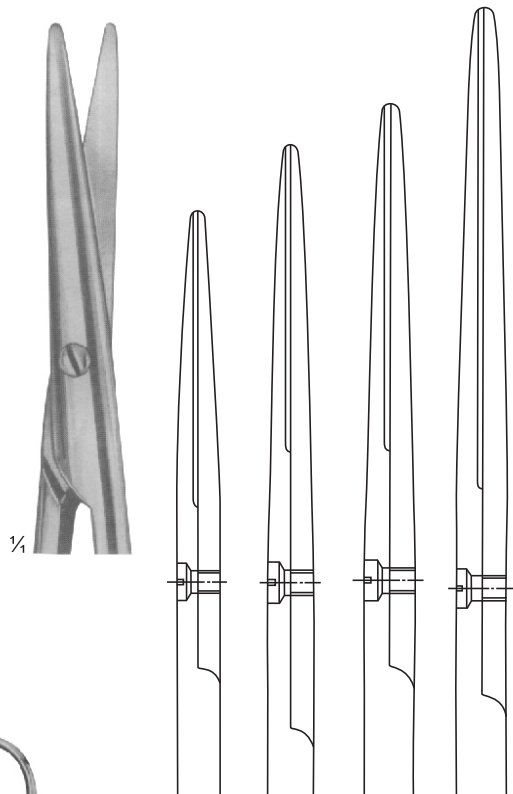

JJ-02-291
230 mm

JJ-02-292
250 mm

JJ-02-293
280 mm

JJ-02-294
305 mm

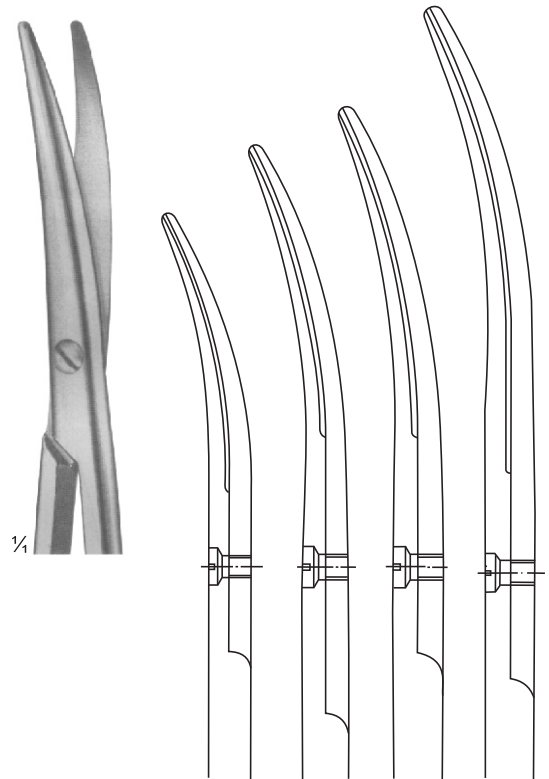

JJ-02-295
230 mm

JJ-02-296
250 mm

JJ-02-297
280 mm

JJ-02-298
305 mm

CARDIOVASCULAR AND NEURO-SURGERY SCISSORS

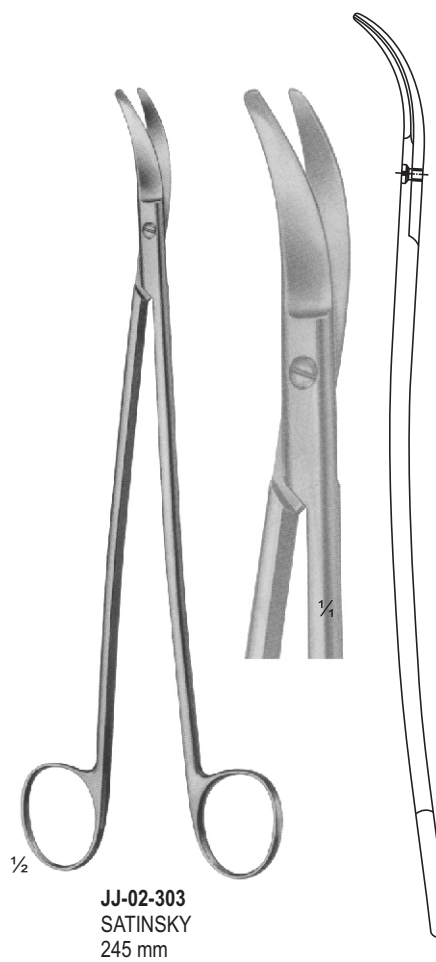
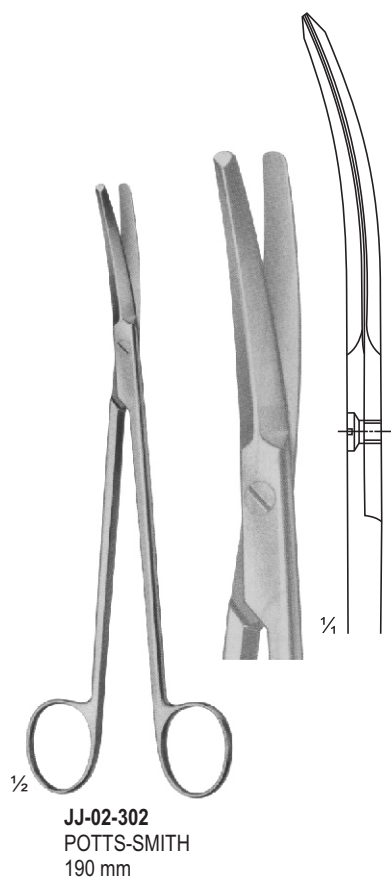
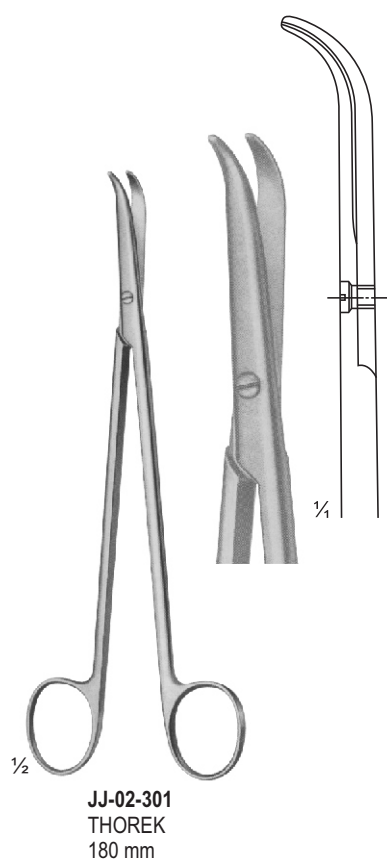
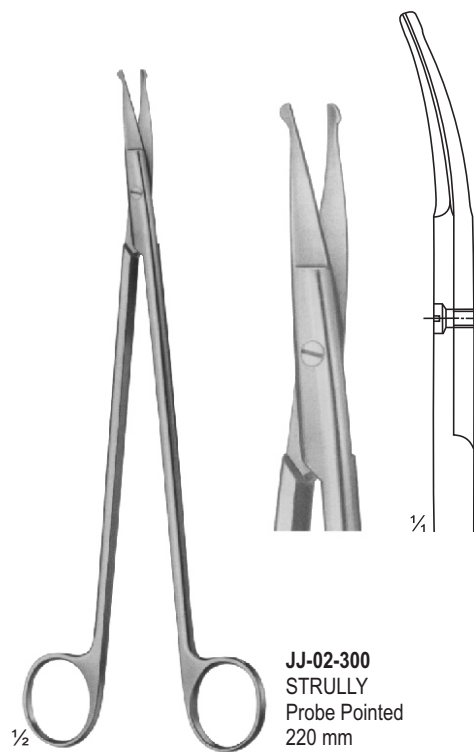
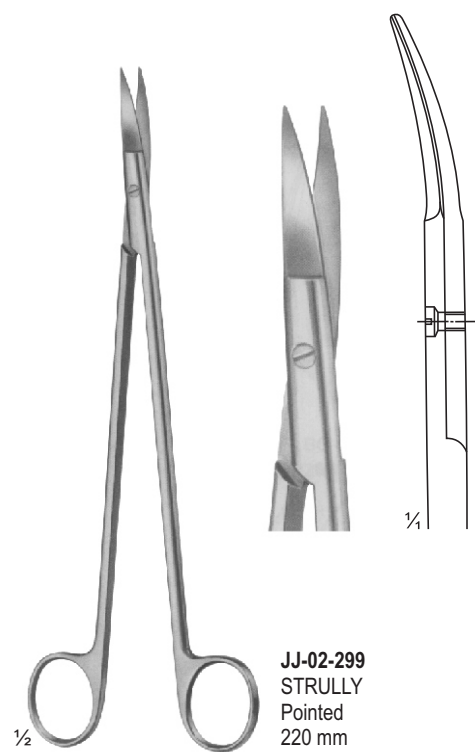

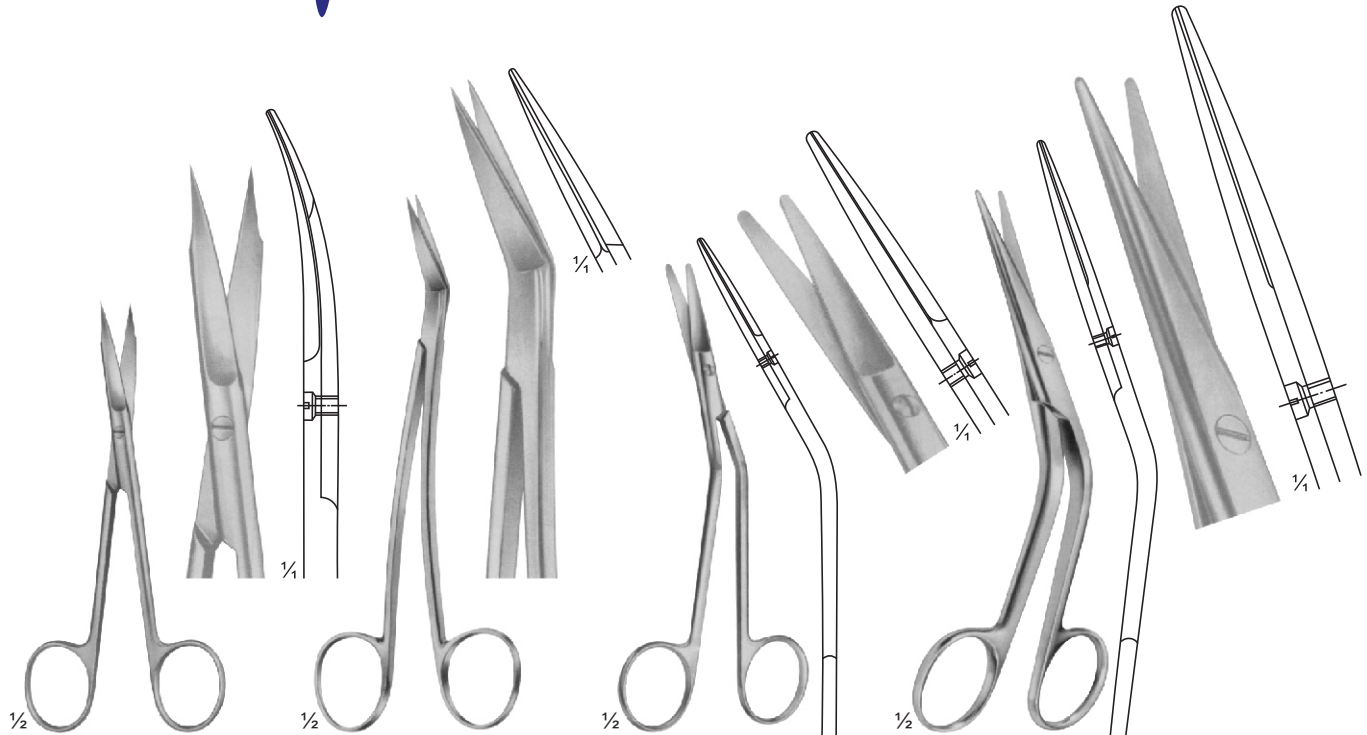

JJ-02-304
Goldman-Fox
1 Finely Toothed Blade
130 mm

JJ-02-305
LOCKLIN
Curved Sideways,
1 Toothed Blade
155 mm

JJ-02-306
FOMON
Blades Serrated
145 mm

JJ-02-307
COTTLE
165 mm

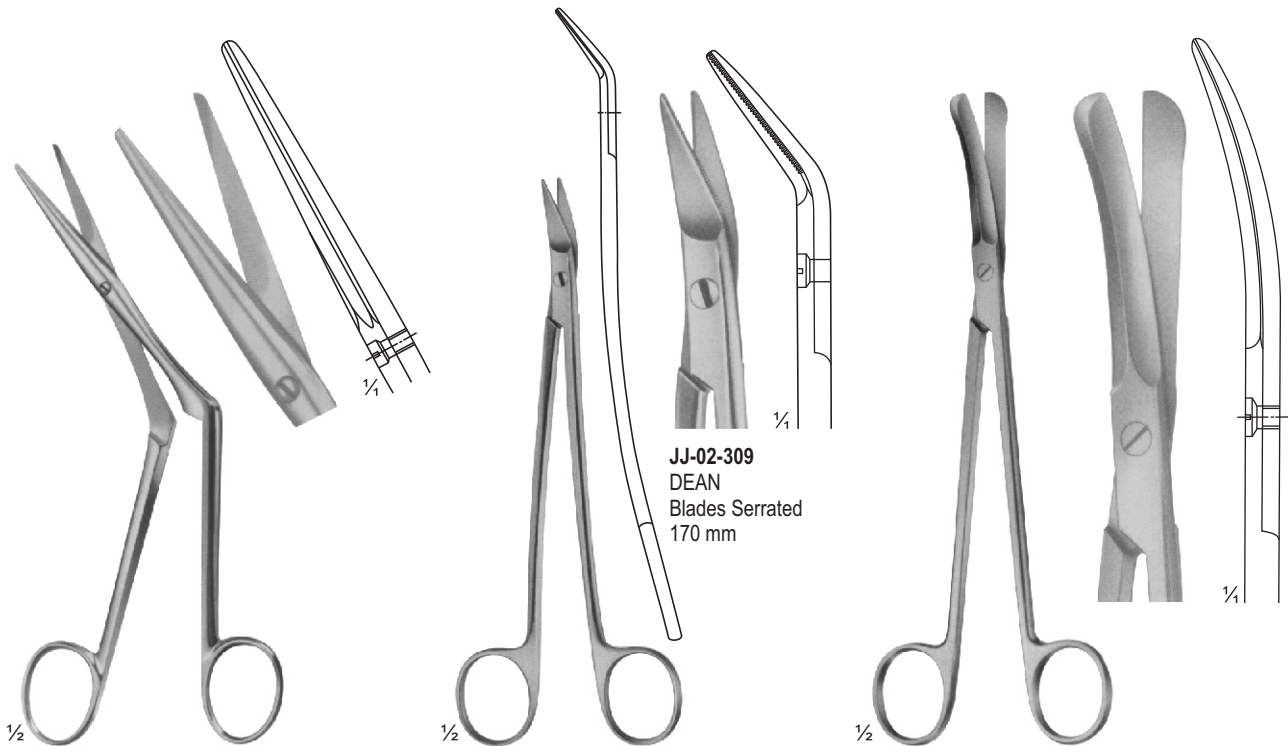

JJ-02-308
HEYMANN-KNIGHT
175 mm

JJ-02-309
DEAN
Blades Serrated
170 mm

JJ-02-310
GOOD
195 mm

OPERATING AND GYNAECOLOGY SCISSORS

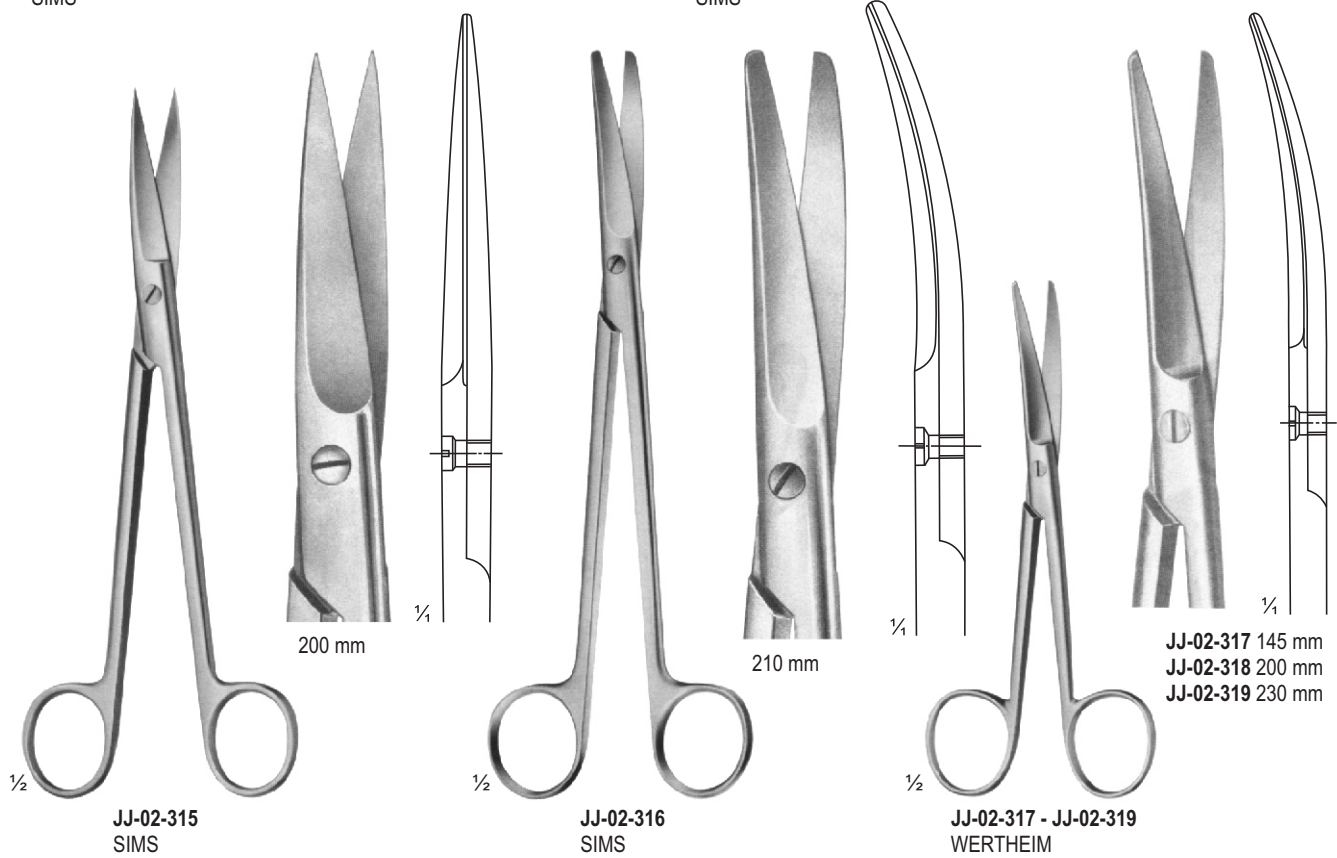
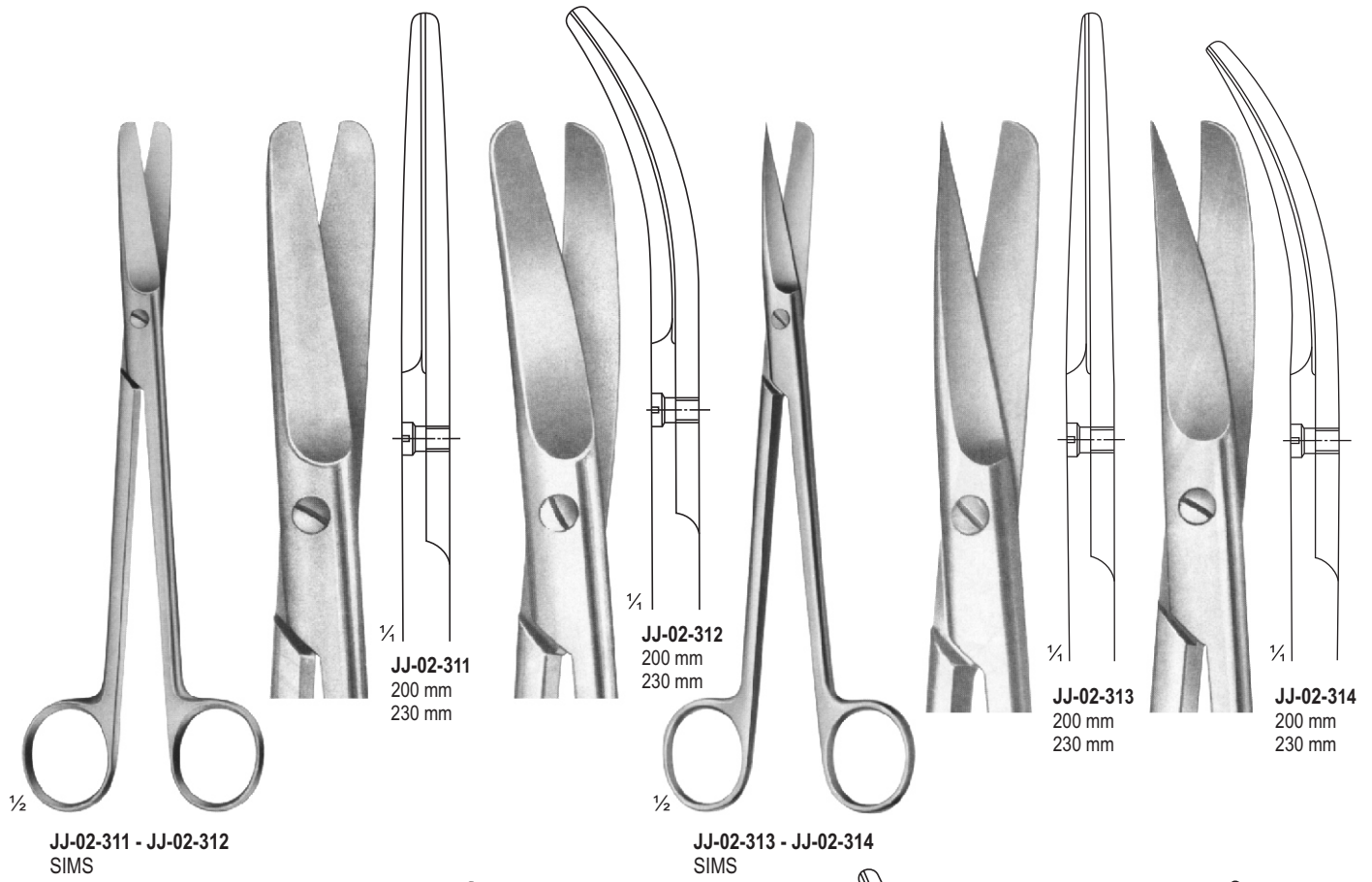

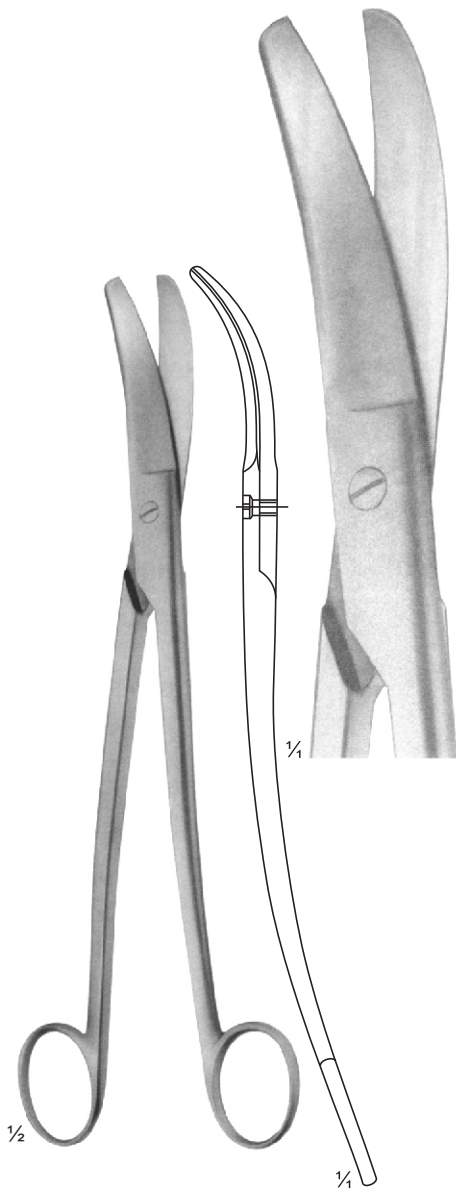

JJ-02-320
SIEBOLD
Uterine Scissors
245 mm

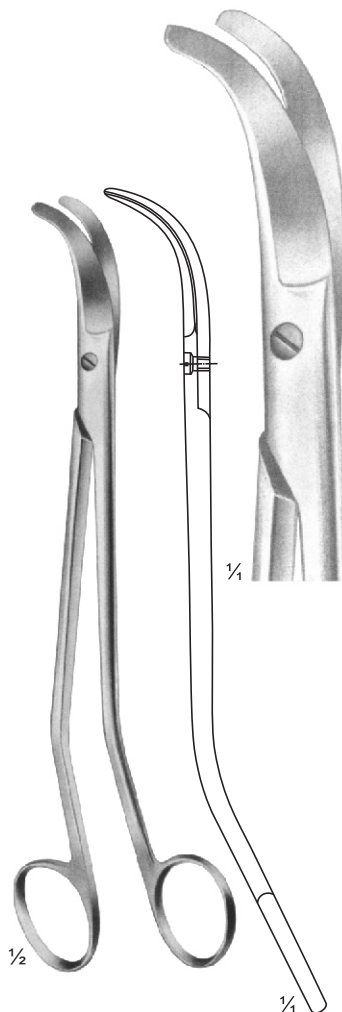

JJ-02-321
BOZEMANN
Uterine Scissors
220 mm

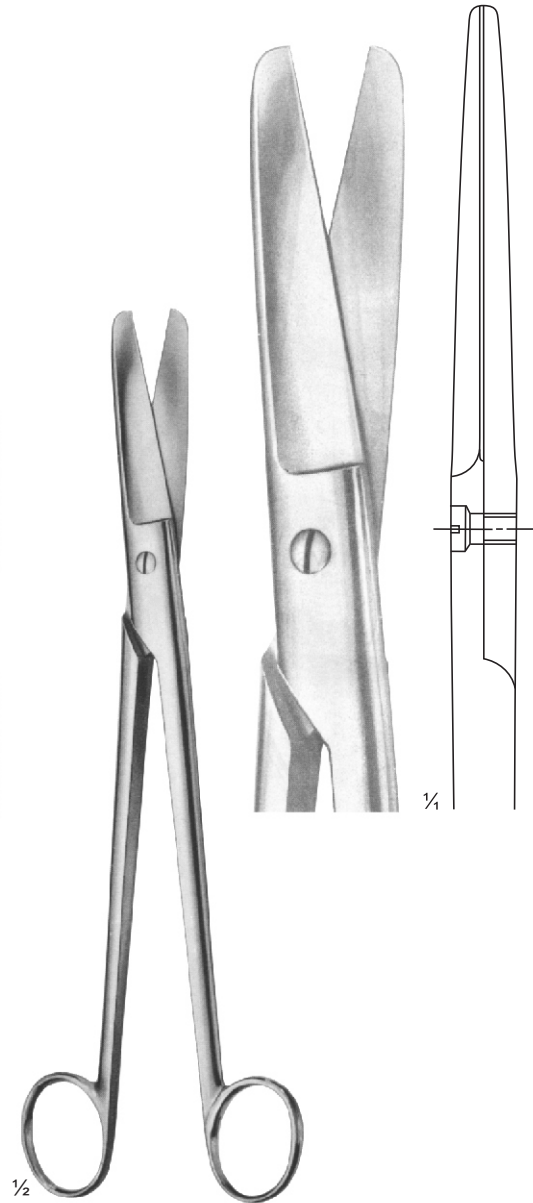

JJ-02-322
SIMS-SIEBOLD
Uterine Scissors
250 mm

OPERATING AND GYNAECOLOGY SCISSORS

1/2

JJ-02-323
SCHUMACHER
Umbilical Cord Scissors
155 mm



1/4

1/2

JJ-02-324
Umbilical Cord Scissors
105 mm

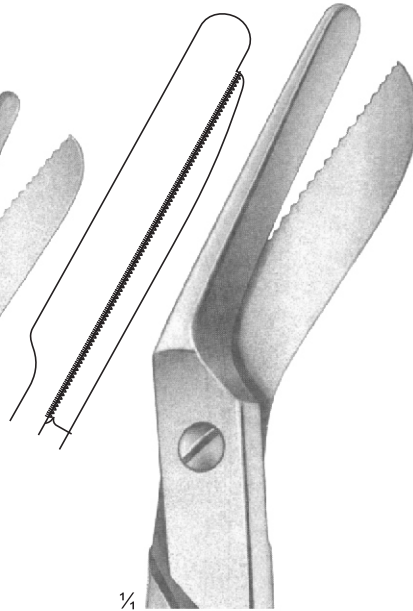

1/4

JJ-02-326
145 mm

1/4

JJ-02-327
200 mm

1/2

JJ-02-325
Umbilical Cord Scissors

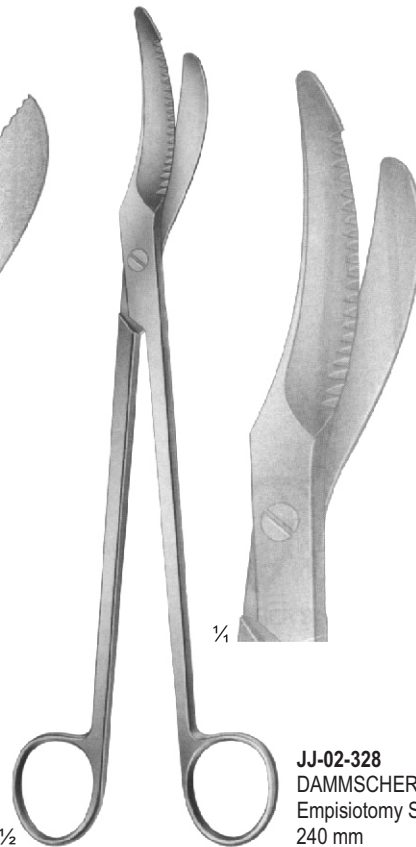

1/4

JJ-02-328
DAMMSCHERE
Empisiotomy Scissors
240 mm

1/2

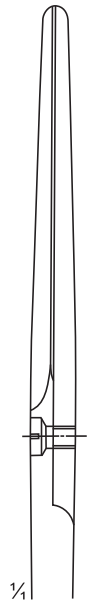

1/4

135 mm

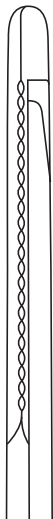

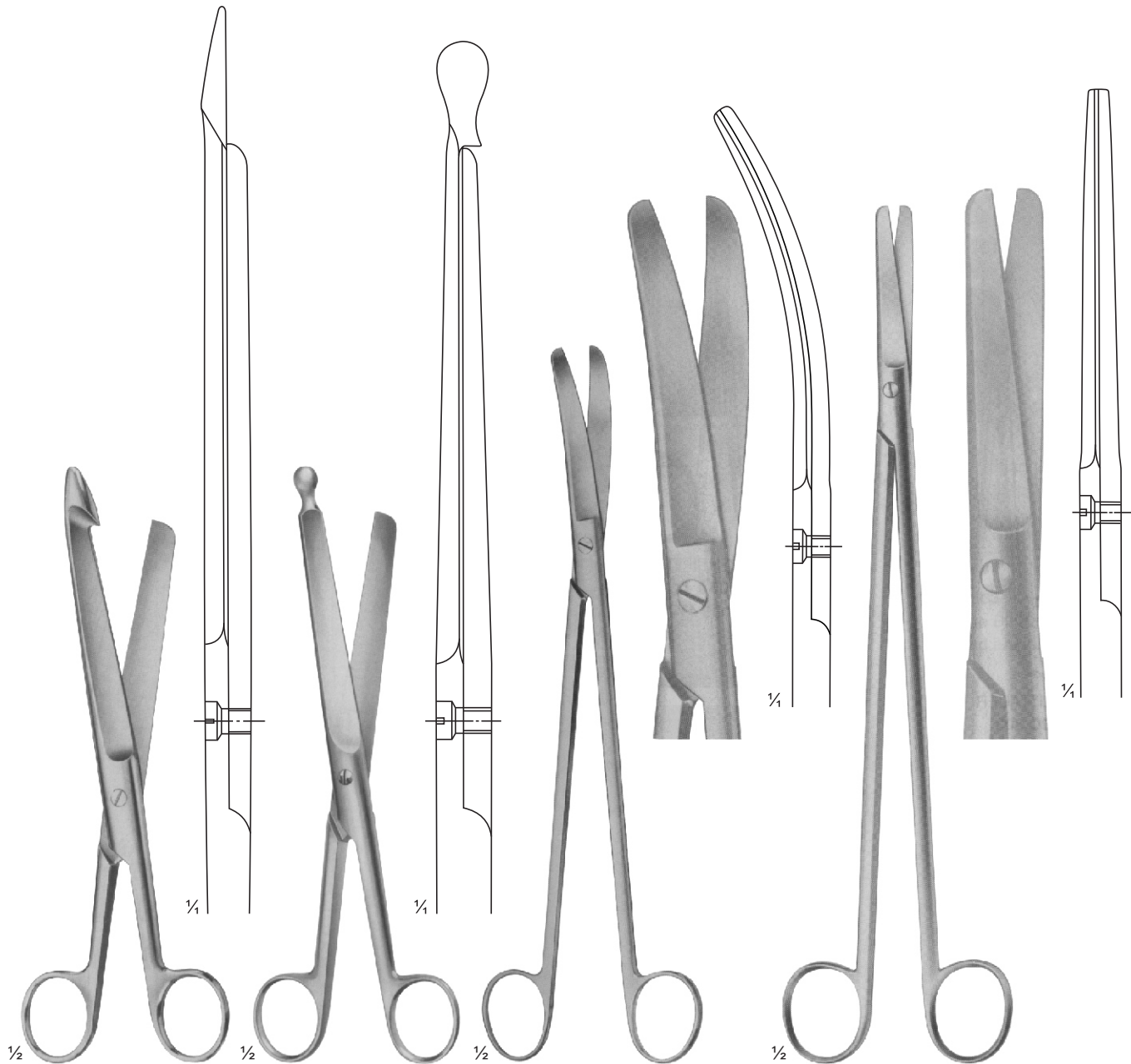

JJ-02-329
DAMMSCHERE
Bowel Scissors
210 mm

JJ-02-330
DAMMSCHERE
Bowel Scissors
210 mm

JJ-02-331
LLOYD-DAVIES
(GOLIGHER'S)
Rectal Scissors
255 mm

JJ-02-332
STELZNER
Rectal Scissors
310 mm

LIGATURE SCISSORS

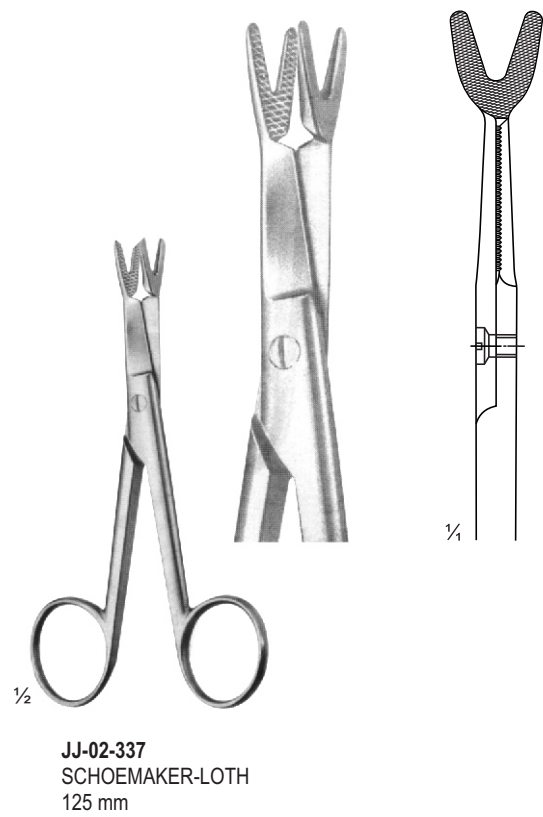
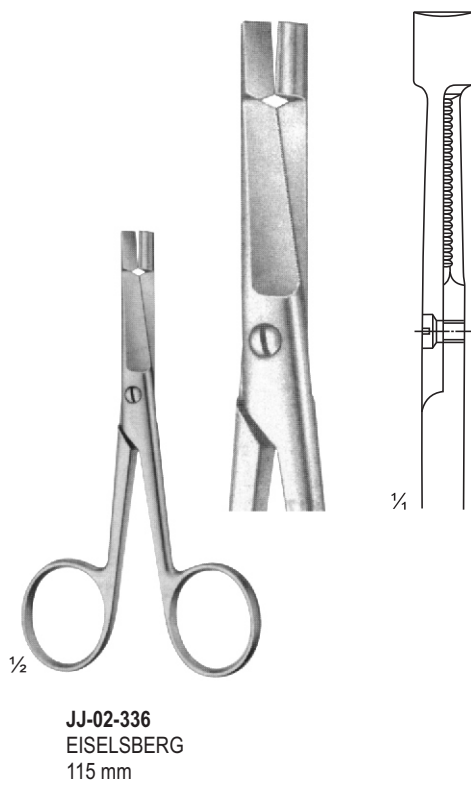
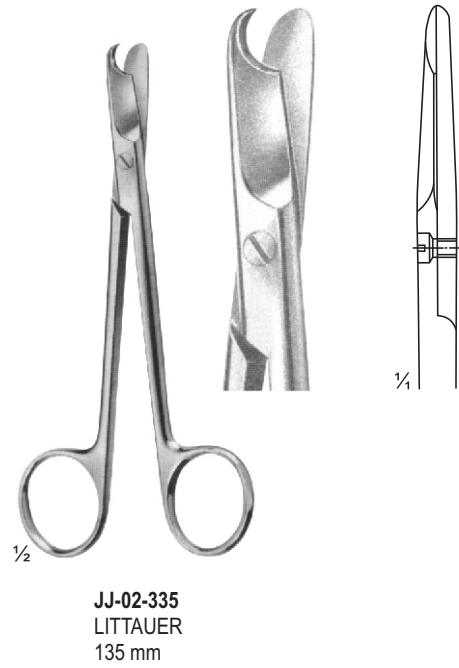
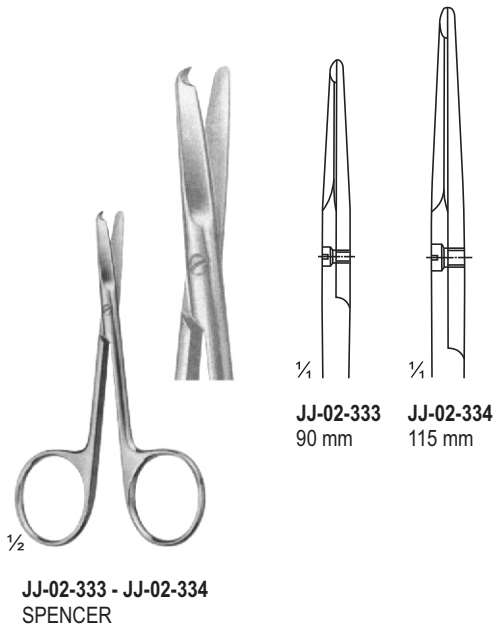

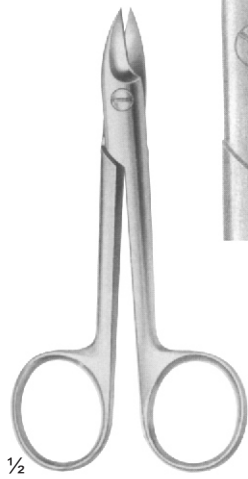

1/2

JJ-02-338 - JJ-02-342
BEEBE
110 mm

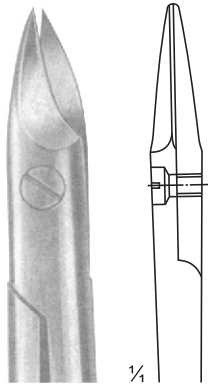

1/4

JJ-02-338

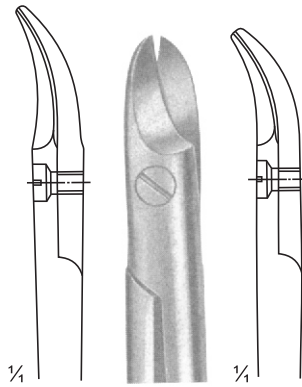

1/4

JJ-02-339

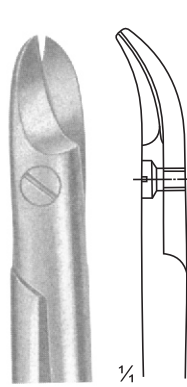

1/4

JJ-02-340
Broad Blades

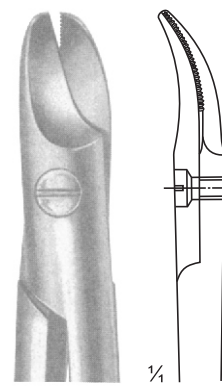

1/4

JJ-02-341
1 Blade Serrated

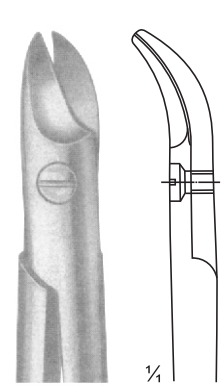

1/4

JJ-02-342
NAUJOKS
Strongly Curved

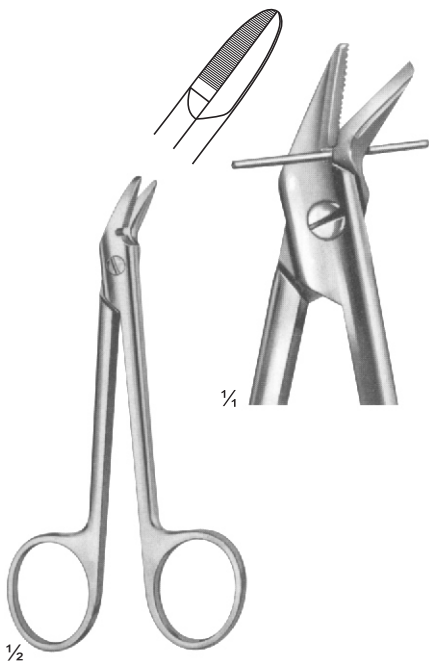

1/2

JJ-02-343
1 Blade Serrated
120 mm

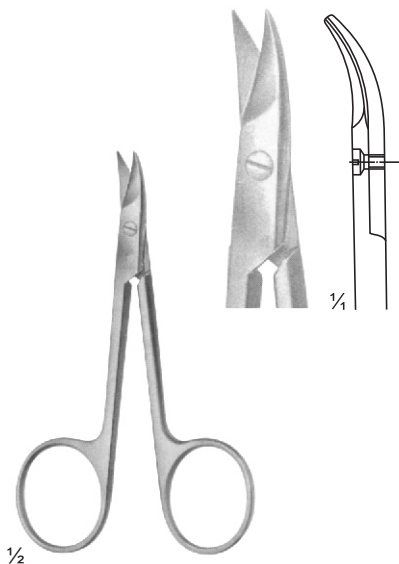

1/2

JJ-02-344
STRACK
100 mm

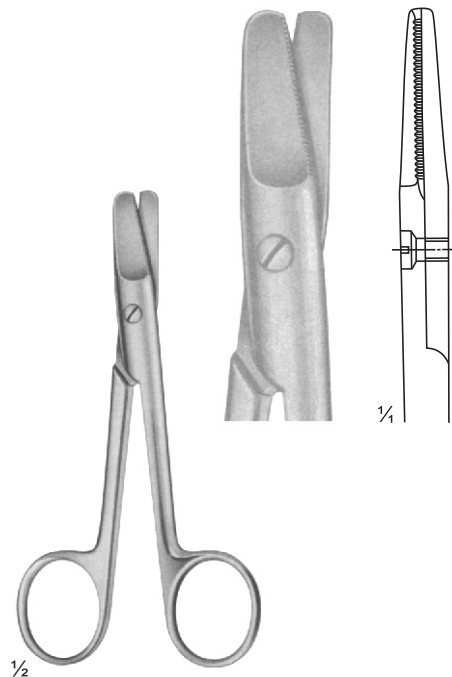

1/2

JJ-02-345
HARVEY
125 mm

WIRE AND PLATE SCISSORS

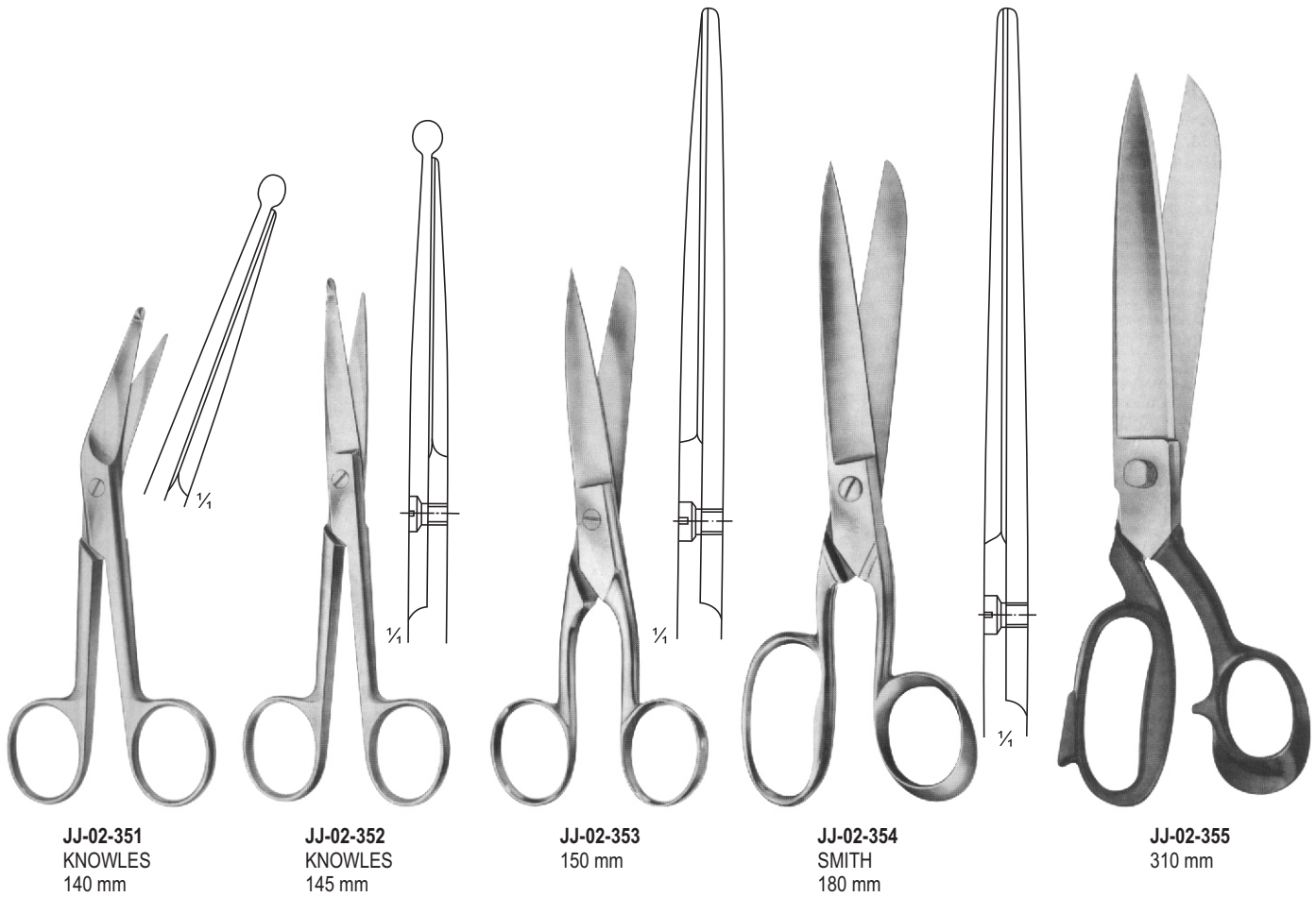
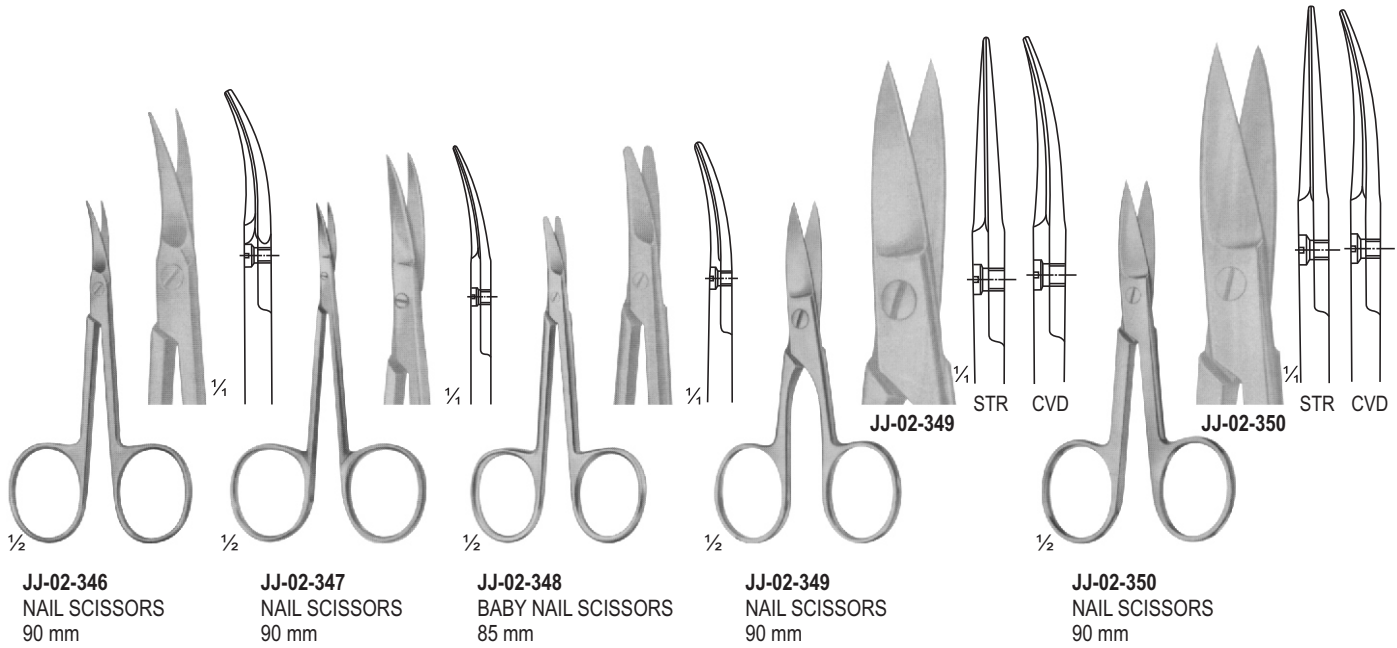

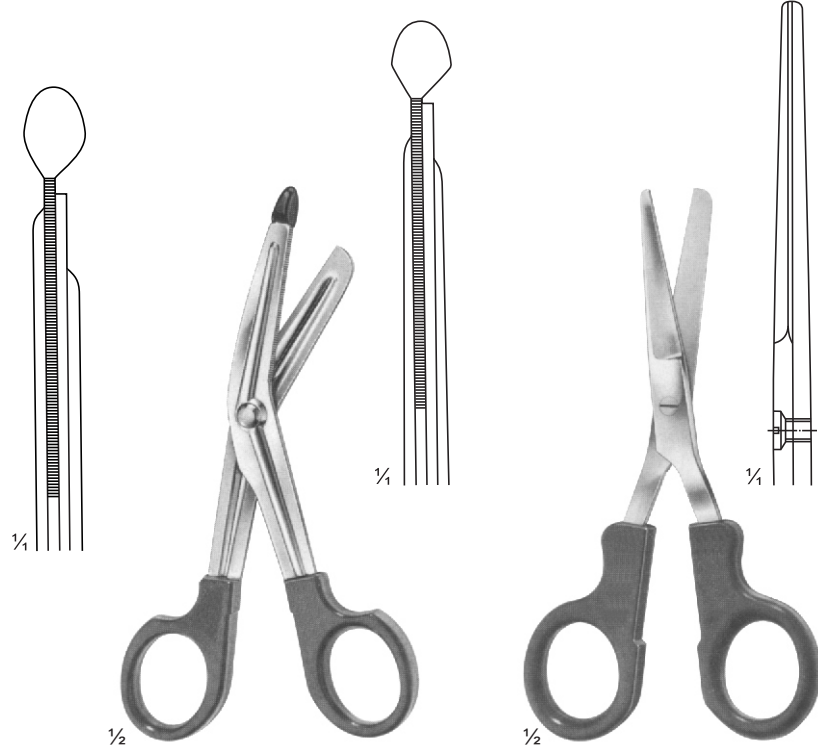

1/2

JJ-02-356
UNIVERSAL AND BANDAGE SCISSORS
180 mm

1/2

JJ-02-357
LISTER
145 mm

1/2

JJ-02-358
LISTER
145 mm

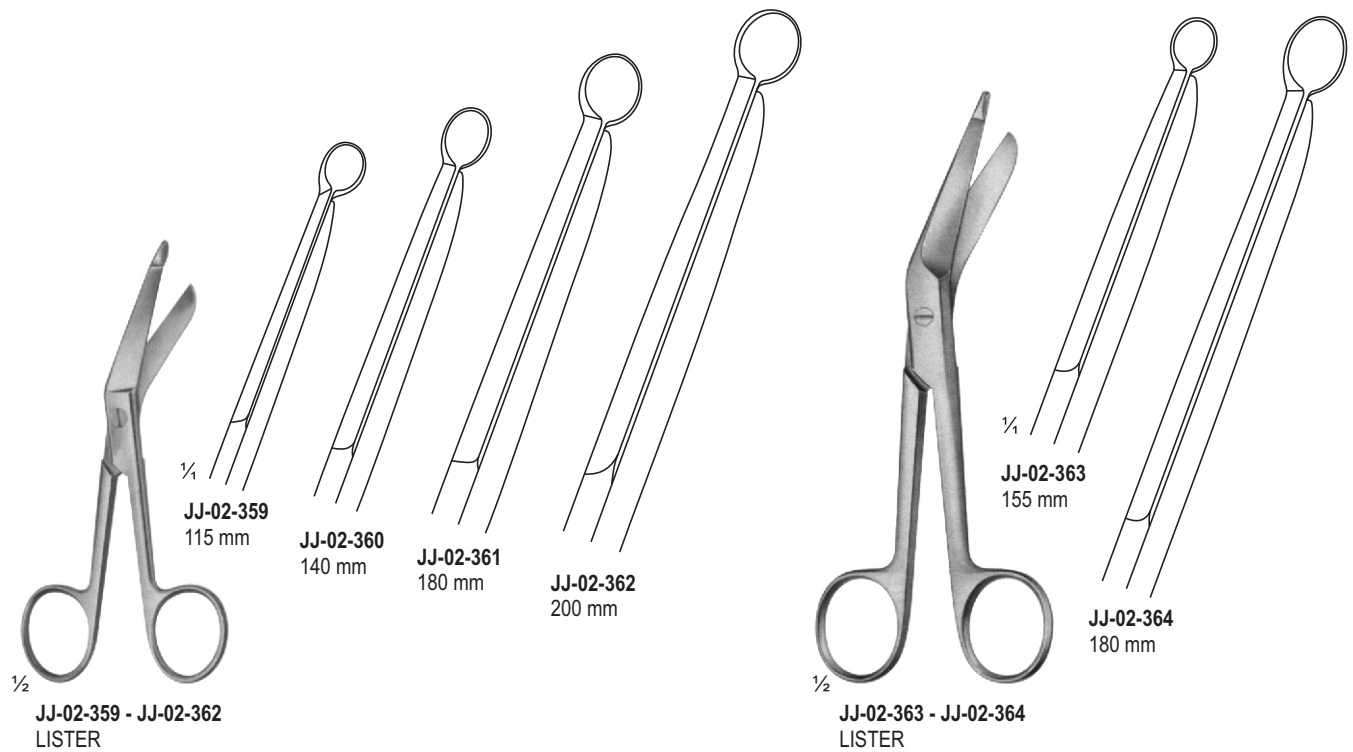

1/2

JJ-02-359 - JJ-02-362
LISTER

JJ-02-359
115 mm

JJ-02-360
140 mm

JJ-02-361
180 mm

JJ-02-362
200 mm

1/2

JJ-02-363 - JJ-02-364
LISTER

JJ-02-363
155 mm

JJ-02-364
180 mm

BANDAGE, CLOTH AND PLASTER SCISSORS



JJ-02-365
CLOTH SCISSORS
205 mm

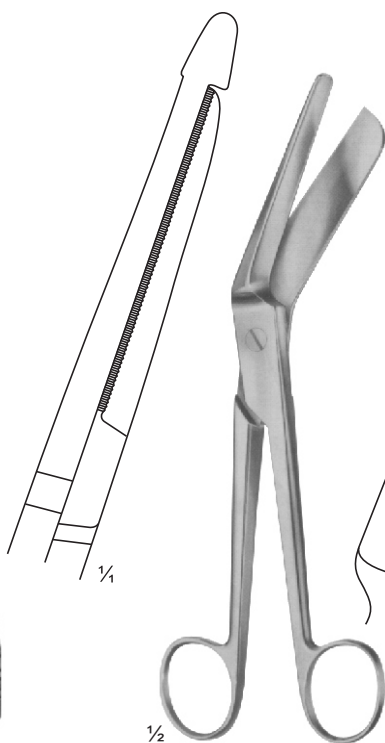

JJ-02-366
BRAUN-STADLER
225 mm

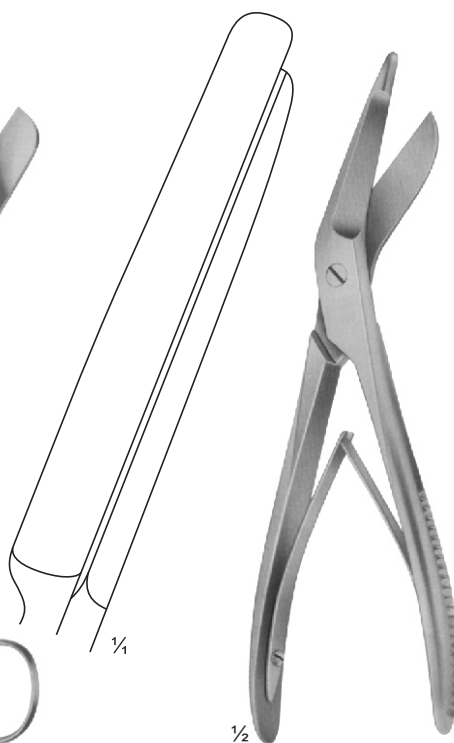

JJ-02-367
SEUTIN
230 mm

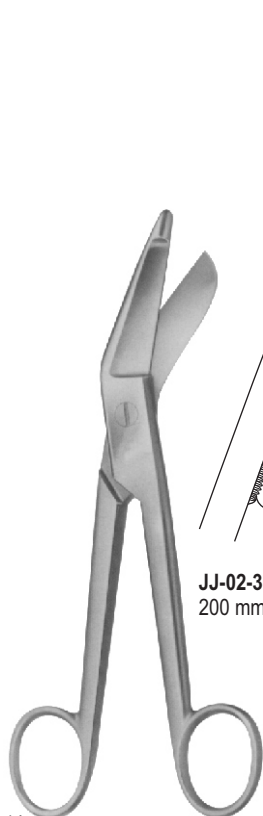

JJ-02-368 - JJ-02-369
ESMARCH

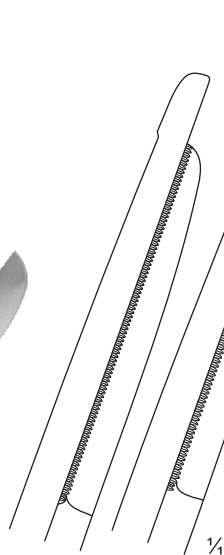

JJ-02-368 200 mm
JJ-02-369 230 mm

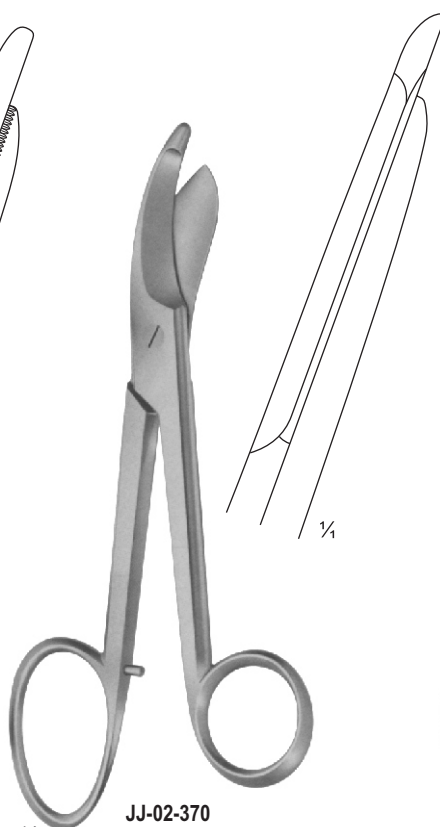

JJ-02-370
BRUNS
235 mm

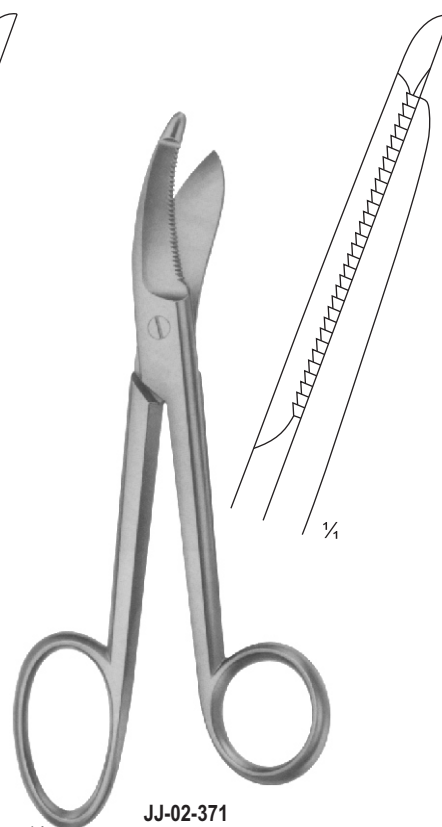

JJ-02-371
BRUNS
235 mm



STANDARD
JJ-02-372 14.5 cm, 5 3/4"
JJ-02-373 16.5 cm, 6 1/2"
JJ-02-374 18.5 cm, 7 1/4"



STANDARD
JJ-02-375 14.5 cm, 5 3/4"
JJ-02-376 16.5 cm, 6 1/2"
JJ-02-377 18.5 cm, 7 1/4"

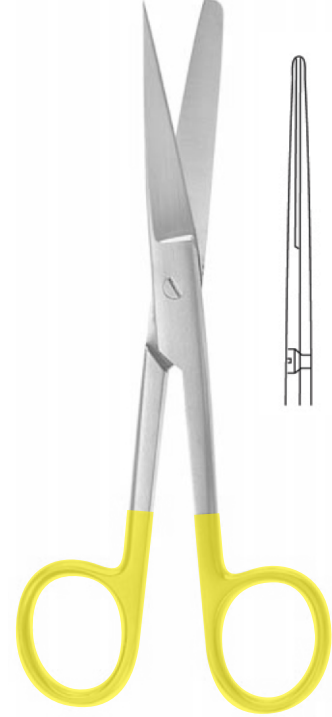

STANDARD
JJ-02-378 14.5 cm, 5 3/4"
JJ-02-379 16.5 cm, 6 1/2"
JJ-02-380 18.5 cm, 7 1/4"

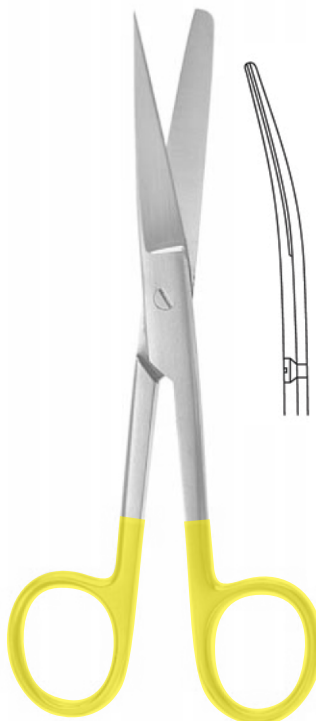

STANDARD
JJ-02-381 14.5 cm, 5 3/4"
JJ-02-382 16.5 cm, 6 1/2"
JJ-02-383 18.5 cm, 7 1/4"

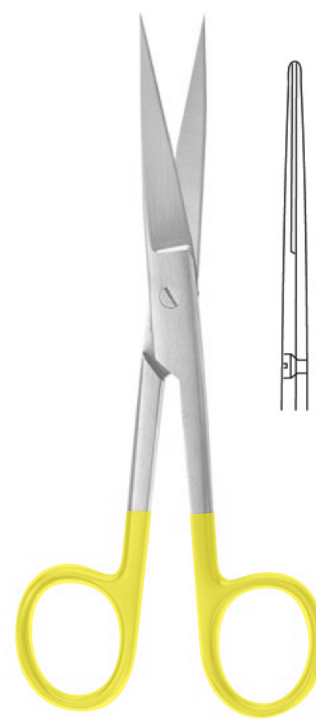

STANDARD
JJ-02-384 14.5 cm, 5 3/4"
JJ-02-385 16.5 cm, 6 1/2"
JJ-02-386 18.5 cm, 7 1/4"



STANDARD
JJ-02-387 14.5 cm, 5 3/4"
JJ-02-388 16.5 cm, 6 1/2"
JJ-02-389 18.5 cm, 7 1/4"

SURGICAL SCISSORS WITH TUNGSTEN CARBIDE EDGES

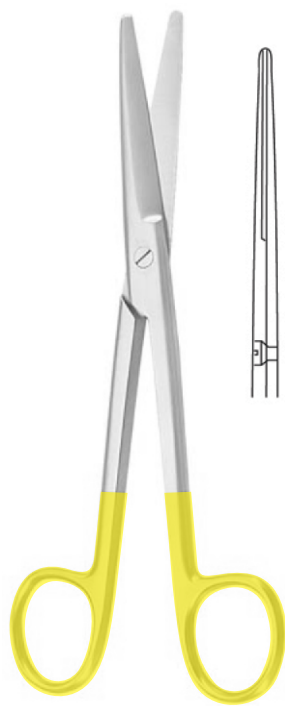

MAYO
JJ-02-390 14.5 cm, 5 3/4"
JJ-02-391 17.0 cm, 6 3/4"
JJ-02-392 23.0 cm, 9"

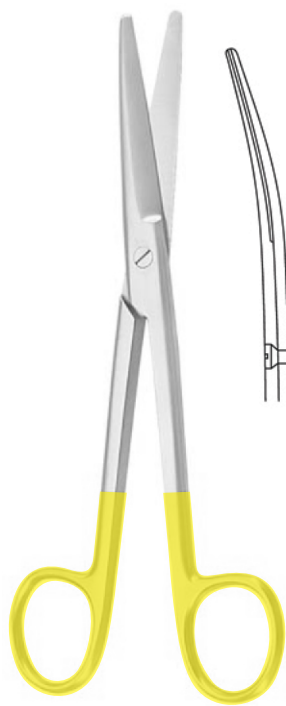

MAYO
JJ-02-393 14.5 cm, 5 3/4"
JJ-02-394 17.0 cm, 6 3/4"
JJ-02-395 23.0 cm, 9"

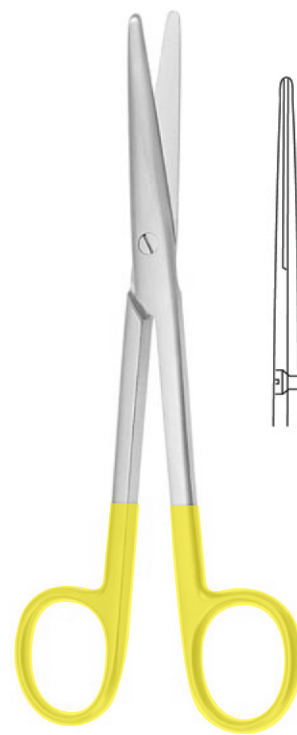

MAYO-STILLE
JJ-02-396 15.0 cm, 6"
JJ-02-397 17.0 cm, 6 3/4"

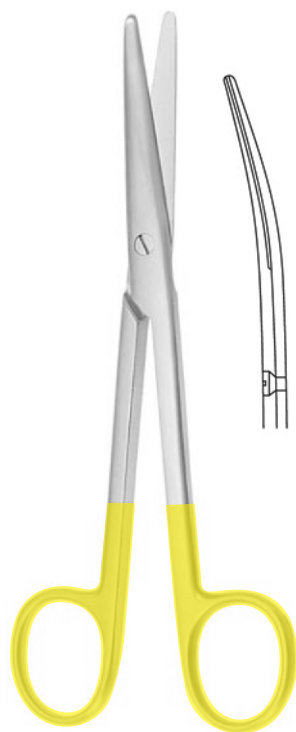

MAYO-STILLE
JJ-02-398 15.0 cm, 6"
JJ-02-399 17.0 cm, 6 3/4"



LEXER
JJ-02-400 16.0 cm, 6 1/4"
JJ-02-401 21.0 cm, 8 1/4"



LEXER
JJ-02-402 16.0 cm, 6 1/4"
JJ-02-403 21.0 cm, 8 1/4"

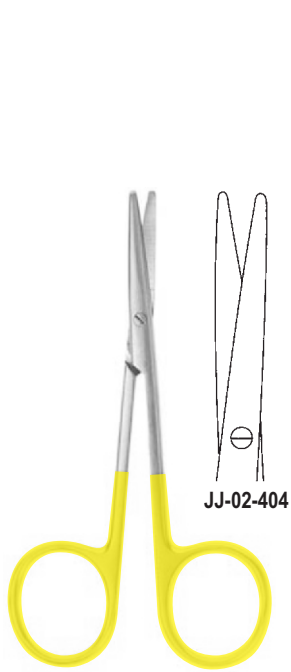

JJ-02-404

BABY-METZENBAUM
JJ-02-404 - JJ-02-405
11.5 cm, 4½"



JJ-02-405

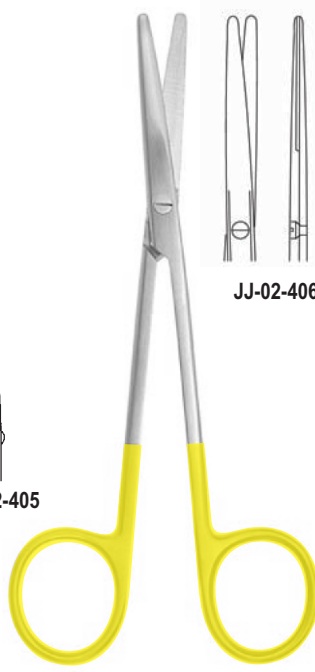

JJ-02-406

JJ-02-407

METZENBAUM
JJ-02-406 - JJ-02-407
14.5 cm, 5 3/4"

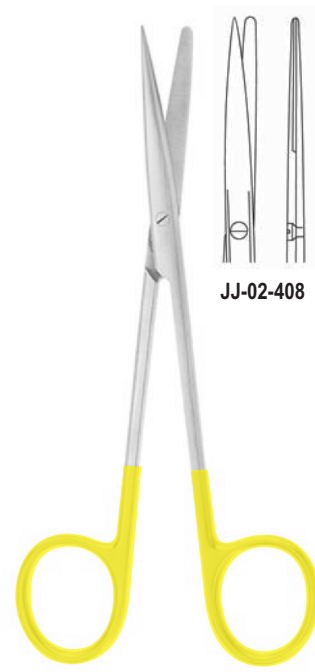

JJ-02-408

JJ-02-409

METZENBAUM
JJ-02-408 - JJ-02-409
14.5 cm, 5 3/4"



JJ-02-410

JJ-02-411

METZENBAUM
JJ-02-410 - JJ-02-411
14.5 cm, 5 3/4"

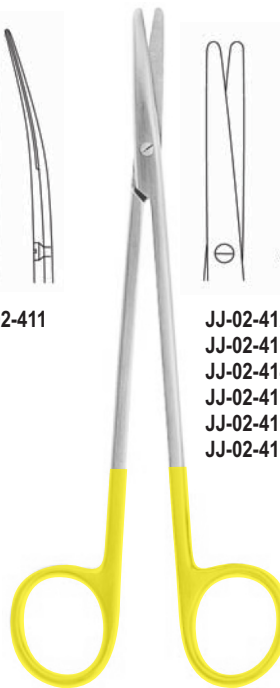

JJ-02-412

JJ-02-413

JJ-02-414

JJ-02-415

JJ-02-416

JJ-02-417

18.0 cm, 7"

20.0 cm, 8"

23.0 cm, 9"

25.0 cm, 10"

28.0 cm, 11"

30.0 cm, 12"

METZENBAUM
JJ-02-412 - JJ-02-417

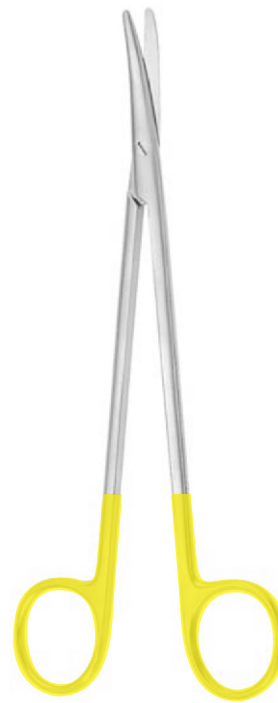

JJ-02-418

JJ-02-419

JJ-02-420

JJ-02-421

JJ-02-422

JJ-02-423

18.0 cm, 7"

20.0 cm, 8"

23.0 cm, 9"

25.0 cm, 10"

28.0 cm, 11"

30.0 cm, 12"

METZENBAUM
JJ-02-418 - JJ-02-423

DISSECTING SCISSORS WITH TUNGSTEN CARBIDE EDGES

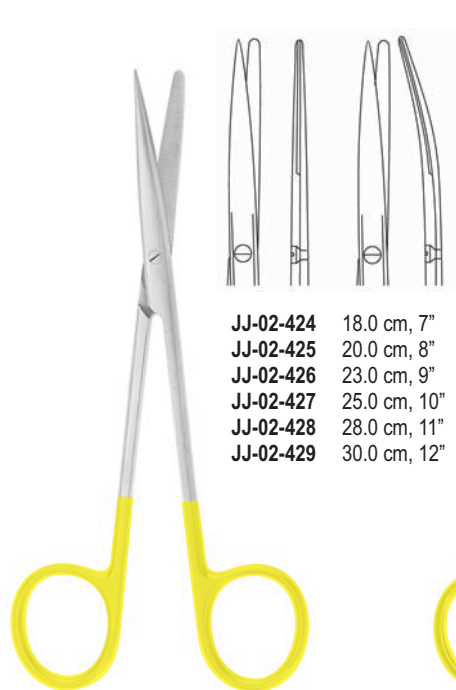

- JJ-02-424** 18.0 cm, 7"
- JJ-02-425** 20.0 cm, 8"
- JJ-02-426** 23.0 cm, 9"
- JJ-02-427** 25.0 cm, 10"
- JJ-02-428** 28.0 cm, 11"
- JJ-02-429** 30.0 cm, 12"

METZENBAUM
JJ-02-424 - JJ-02-429

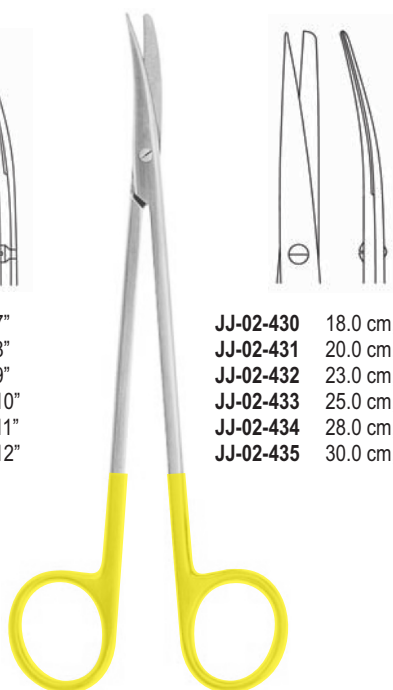

- JJ-02-430** 18.0 cm, 7"
- JJ-02-431** 20.0 cm, 8"
- JJ-02-432** 23.0 cm, 9"
- JJ-02-433** 25.0 cm, 10"
- JJ-02-434** 28.0 cm, 11"
- JJ-02-435** 30.0 cm, 12"

METZENBAUM
JJ-02-430 - JJ-02-435

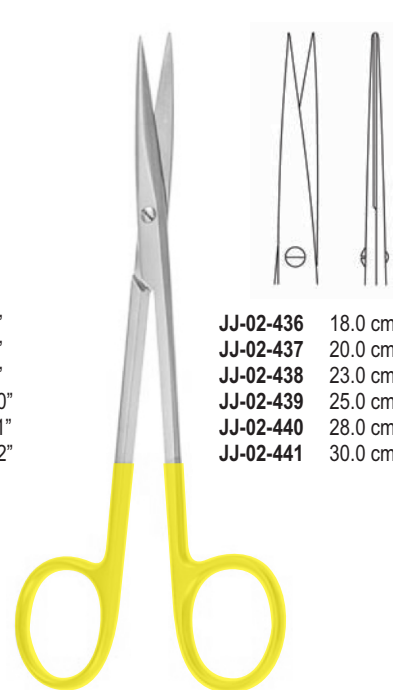

- JJ-02-436** 18.0 cm, 7"
- JJ-02-437** 20.0 cm, 8"
- JJ-02-438** 23.0 cm, 9"
- JJ-02-439** 25.0 cm, 10"
- JJ-02-440** 28.0 cm, 11"
- JJ-02-441** 30.0 cm, 12"

METZENBAUM
JJ-02-436 - JJ-02-441

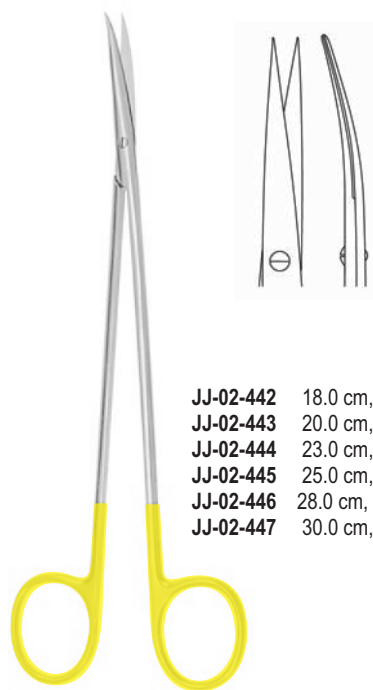

- JJ-02-442** 18.0 cm, 7"
- JJ-02-443** 20.0 cm, 8"
- JJ-02-444** 23.0 cm, 9"
- JJ-02-445** 25.0 cm, 10"
- JJ-02-446** 28.0 cm, 11"
- JJ-02-447** 30.0 cm, 12"

METZENBAUM
JJ-02-442 - JJ-02-447

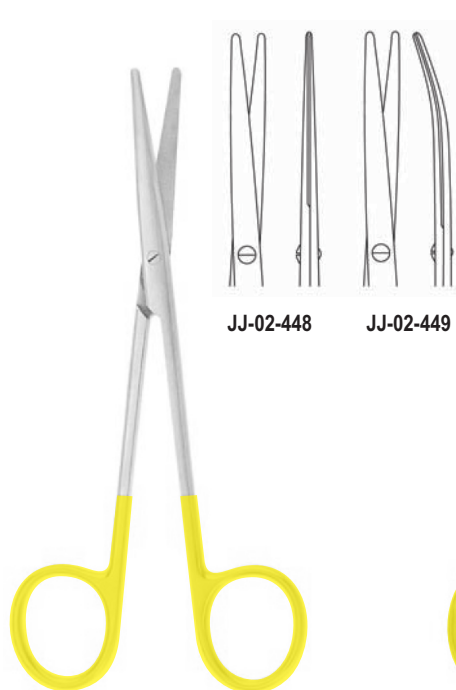

- JJ-02-448**
- JJ-02-449**

METZENBAUM-FINO
JJ-02-448 - JJ-02-449
14.5 cm, 5 3/4"

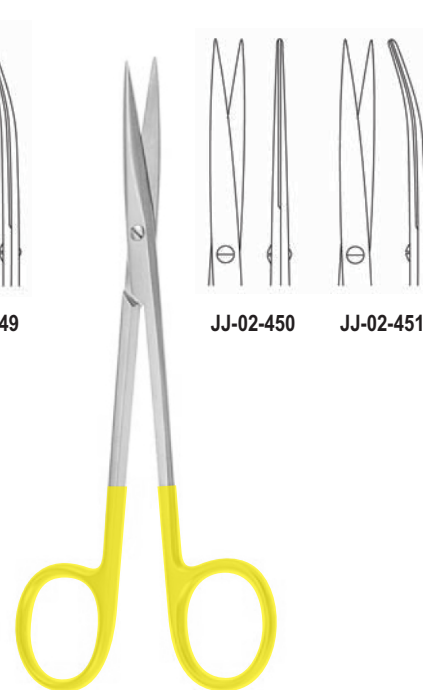

- JJ-02-450**
- JJ-02-451**

METZENBAUM-FINO
JJ-02-450 - JJ-02-451
14.5 cm, 5 3/4"



- JJ-02-452 18.0 cm, 7"
- JJ-02-453 20.0 cm, 8"
- JJ-02-454 23.0 cm, 9"
- JJ-02-455 25.0 cm, 10"
- JJ-02-456 28.0 cm, 11"
- JJ-02-457 30.0 cm, 12"

METZENBAUM-FINO
JJ-02-452 - JJ-02-457

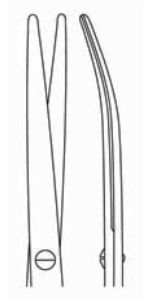
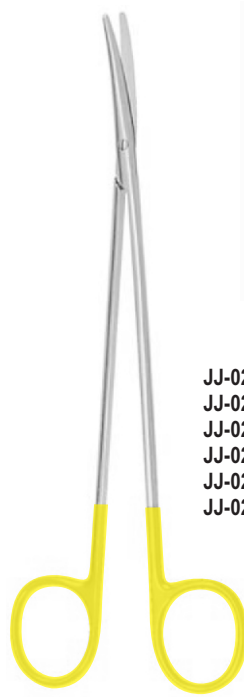

- JJ-02-458 18.0 cm, 7"
- JJ-02-49 20.0 cm, 8"
- JJ-02-460 23.0 cm, 9"
- JJ-02-461 25.0 cm, 10"
- JJ-02-462 28.0 cm, 11"
- JJ-02-463 30.0 cm, 12"

METZENBAUM-FINO
JJ-02-458 - JJ-02-463

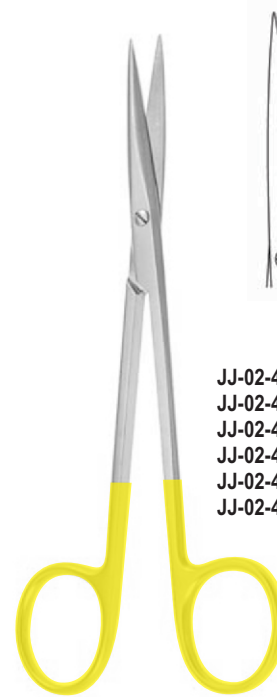

- JJ-02-464 18.0 cm, 7"
- JJ-02-465 20.0 cm, 8"
- JJ-02-466 23.0 cm, 9"
- JJ-02-467 25.0 cm, 10"
- JJ-02-468 28.0 cm, 11"
- JJ-02-469 30.0 cm, 12"

METZENBAUM-FINO
JJ-02-464 - JJ-02-469

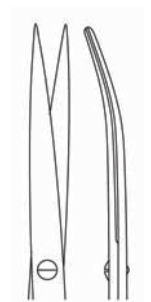

- JJ-02-470 18.0 cm, 7"
- JJ-02-471 20.0 cm, 8"
- JJ-02-472 23.0 cm, 9"
- JJ-02-473 25.0 cm, 10"
- JJ-02-474 28.0 cm, 11"
- JJ-02-475 30.0 cm, 12"

METZENBAUM-FINO
JJ-02-470 - JJ-02-475

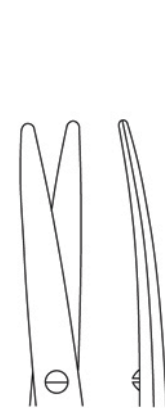

METZENBAUM-LAHEY
JJ-02-476
14.5 cm, 5½"

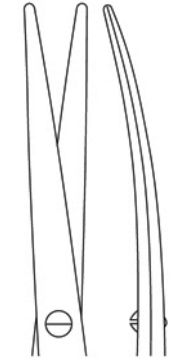
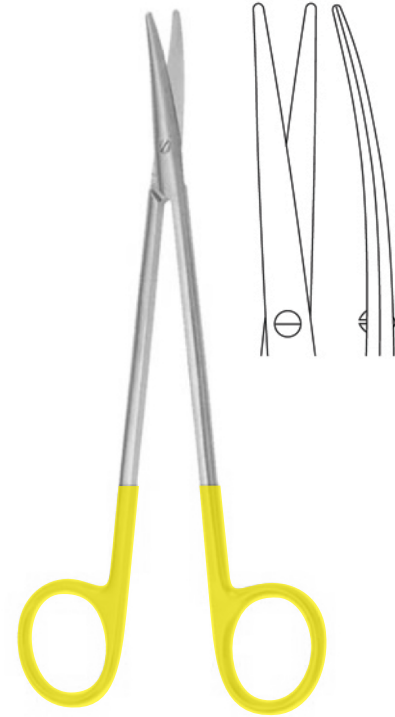

TOENNIS-ADSON
JJ-02-477
17.0 cm, 6 3/4"

DISSECTING SCISSORS WITH TUNGSTEN CARBIDE EDGES

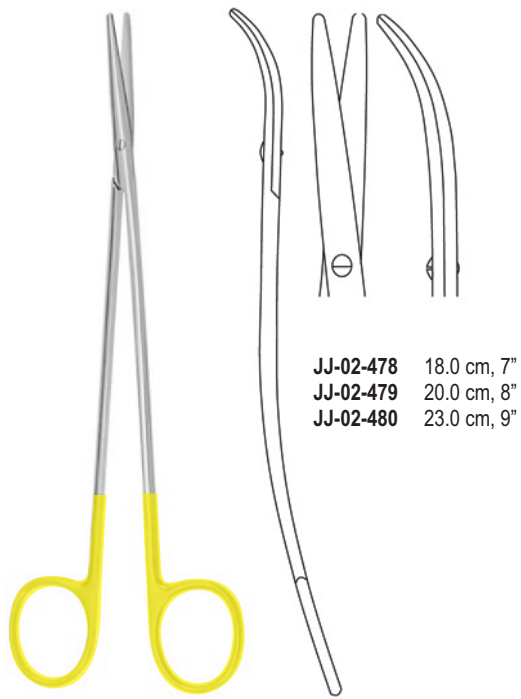

JJ-02-478 18.0 cm, 7"
JJ-02-479 20.0 cm, 8"
JJ-02-480 23.0 cm, 9"

METZENBAUM-FINO
JJ-02-478 - JJ-02-480

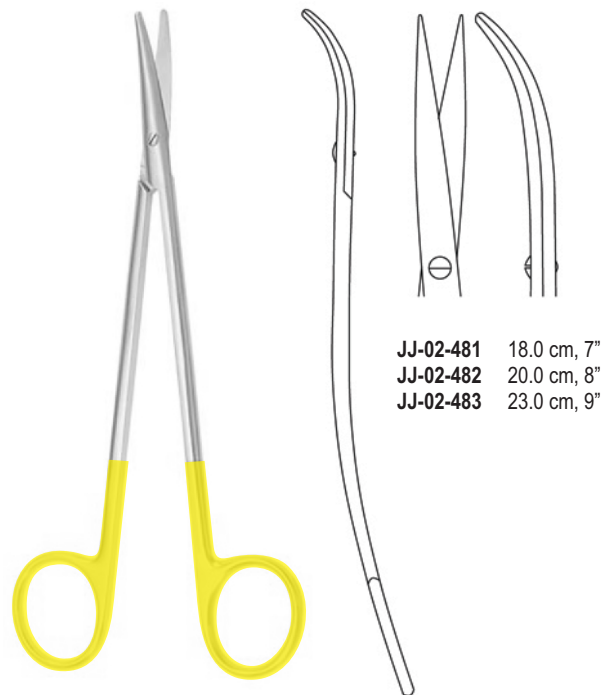

JJ-02-481 18.0 cm, 7"
JJ-02-482 20.0 cm, 8"
JJ-02-483 23.0 cm, 9"

METZENBAUM-FINO
JJ-02-481 - JJ-02-483

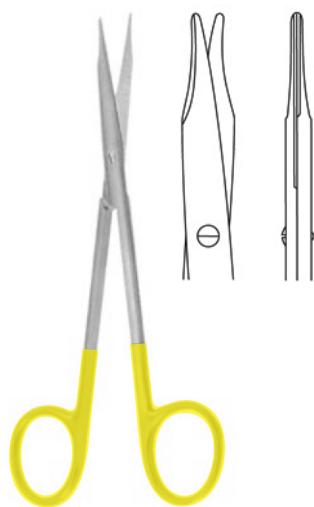

REYNOLDS
JJ-02-484
 15.0 cm, 6"



REYNOLDS
JJ-02-485
 15.0 cm, 6"



HYSTEREKTOMY
JJ-02-486
 25.5 cm, 10"



HYSTEREKTOMY
JJ-02-487
 25.5 cm, 9 3/4"



SIMS
JJ-02-488 - JJ-02-489

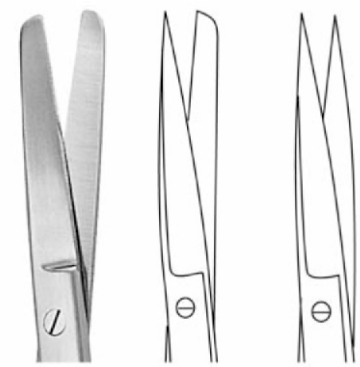

JJ-02-488 20.0 cm, 8"
JJ-02-489 23.0 cm, 9"



SIMS
JJ-02-490 - JJ-02-491

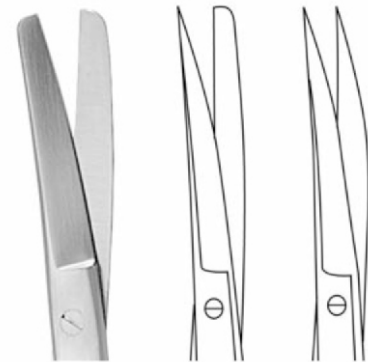

JJ-02-490 20.0 cm, 8"
JJ-02-491 23.0 cm, 9"

VASCULAR SCISSORS WITH TUNGSTEN CARBIDE EDGES



DIETRICH
JJ-02-492
 17.5 cm, 6 5/8"



POTTS DE MARTEL
JJ-02-493
 24.0 cm, 9 1/2"

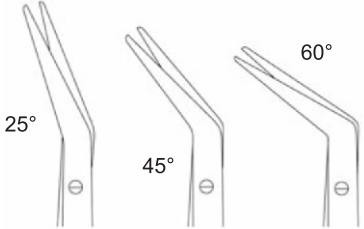

JJ-02-494 20.0 cm, 8"
JJ-02-495 23.0 cm, 9"

DE BAKEY
JJ-02-494 - JJ-02-495

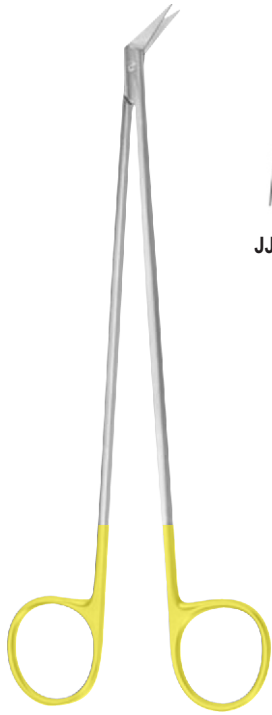

DIETRICH-HEGEMANN
JJ-02-496 - JJ-02-500
18.0 cm, 7"

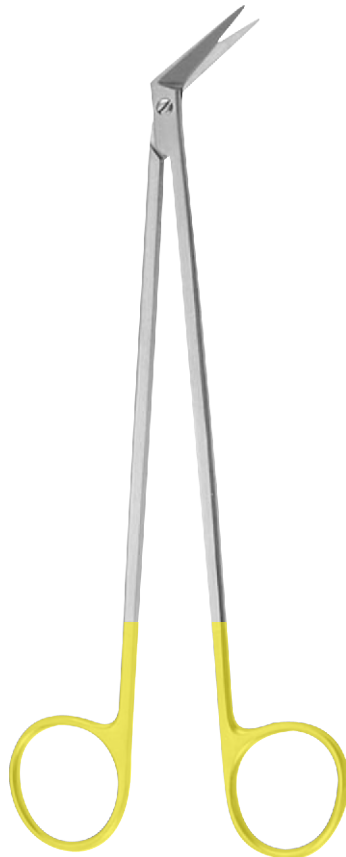
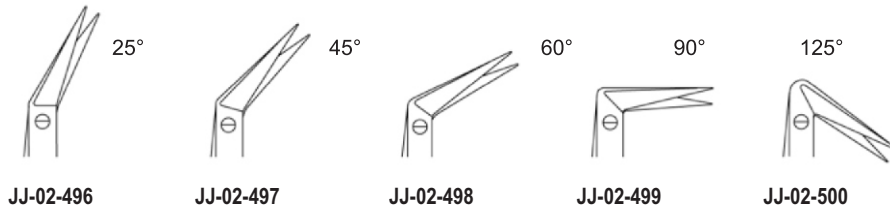

POTTS-SMITH
JJ-02-501 - JJ-02-503
18.0 cm, 7½"

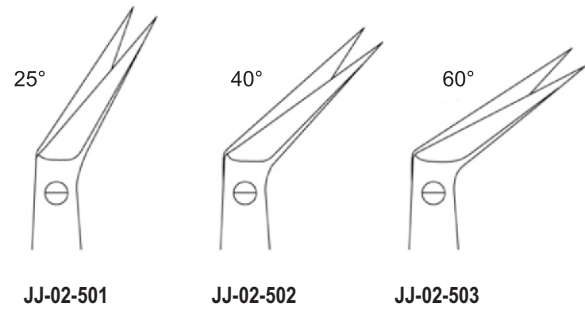

SCISSORS WITH TUNGSTEN CARBIDE EDGES

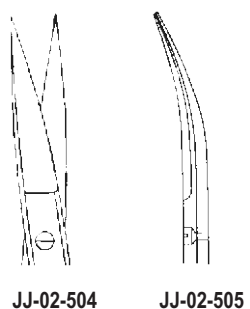
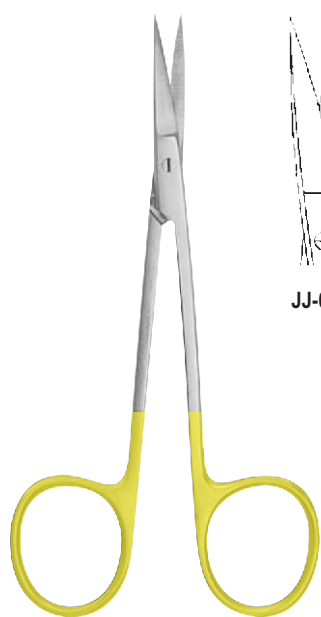

JJ-02-504

JJ-02-505

IRIS
JJ-02-504 - JJ-02-505
11.5 cm, 4½"

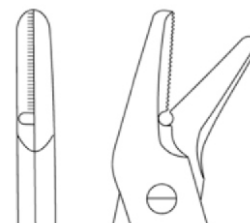
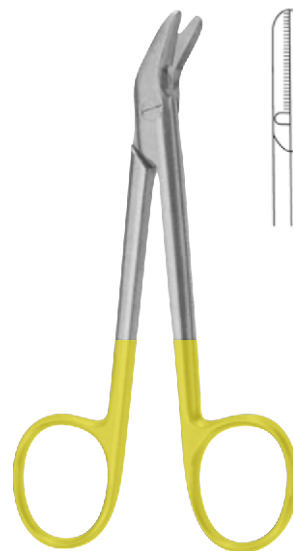

gezahnt
serrated
dentada
dentata

UNIVERSAL
JJ-02-506
12.0 cm, 4 ¾"

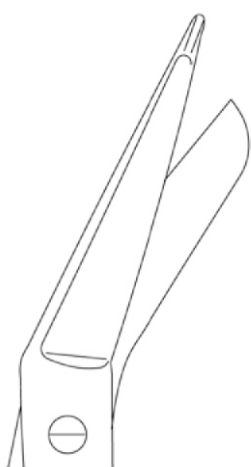
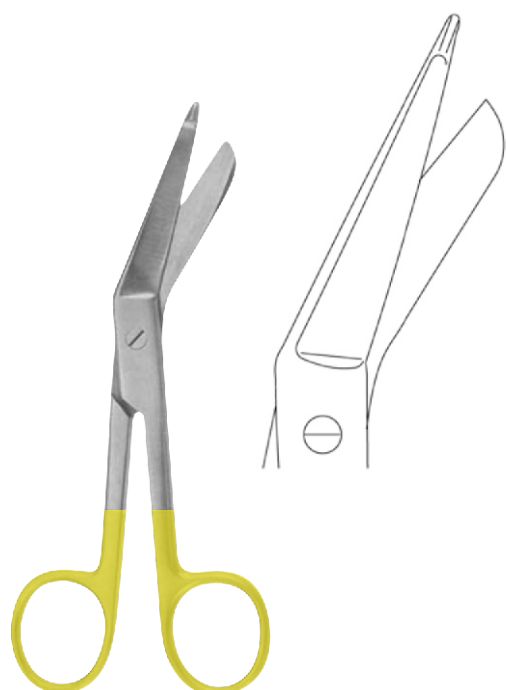

LISTER
JJ-02-507
18.0 cm, 7"

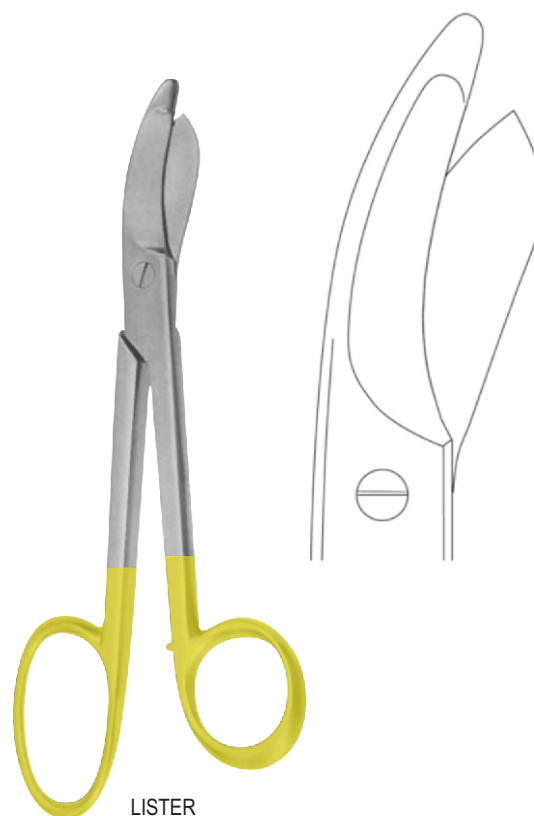

LISTER
BC-408
24.0 cm, 9½"

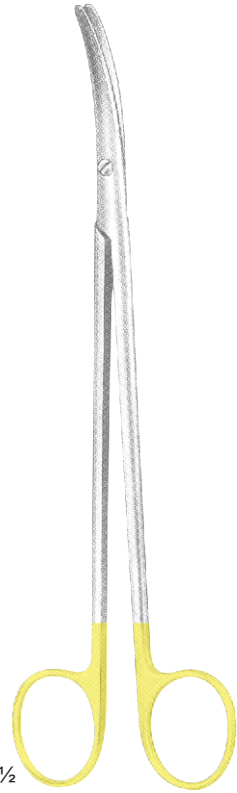

1/2

METZENBAUM-THOREK
JJ-02-509 - JJ-02-511

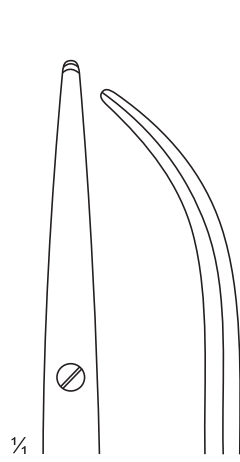

1/4

JJ-02-509
200 mm

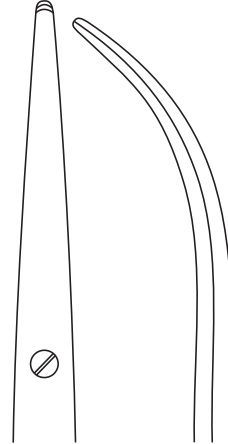

1/4

JJ-02-510
230 mm

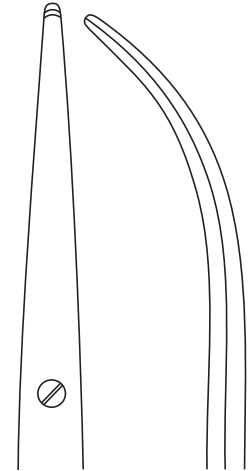

1/4

JJ-02-511
280 mm

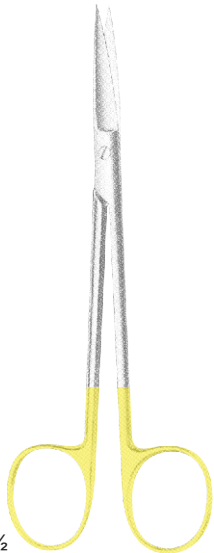

1/2

JOSEPH
JJ-02-512 - JJ-02-513



1/4

JJ-02-512
14.5 cm



1/4

JJ-02-513
14.5 cm

DELICATE DISSECTING SCISSORS WITH TUNGSTEN CARBIDE

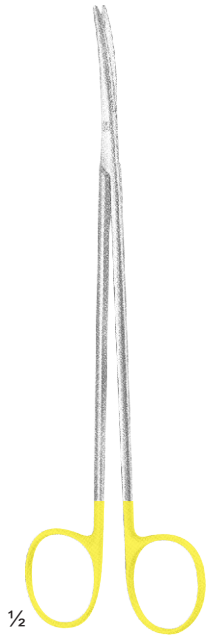

TOENNIS-ADSON
JJ-02-514
 175 mm
 slender pattern

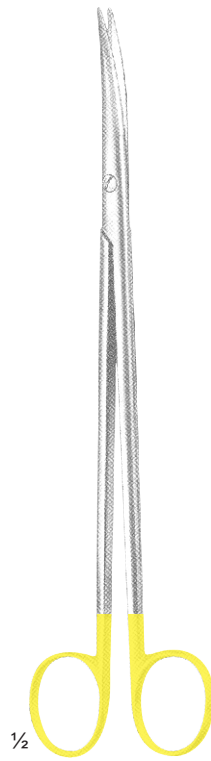

METZENBAUM-FINO
JJ-02-515 - JJ-02-516
 slender pattern

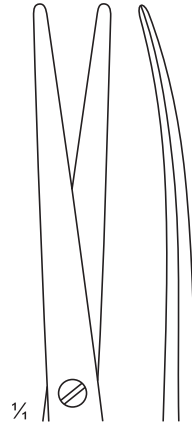

JJ-02-515
 205 mm

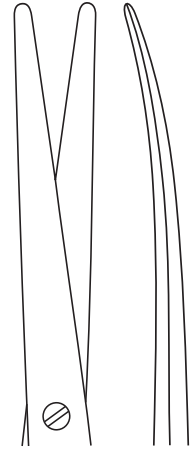

JJ-02-516
 230 mm

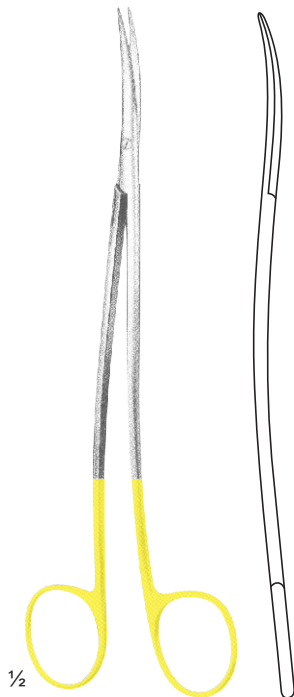

METZENBAUM-FINO
JJ-02-517 - JJ-02-519
 slender pattern



JJ-02-517
 180 mm

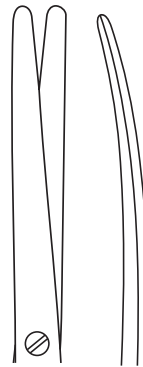

JJ-02-518
 205 mm



JJ-02-519
 230 mm

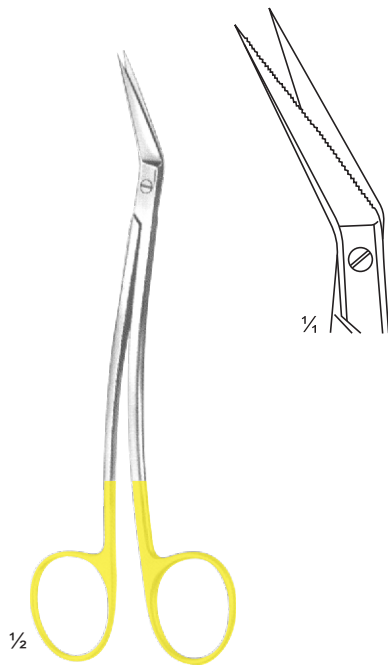

LOCKLIN
JJ-02-520
160 mm
one toothed cutting edge

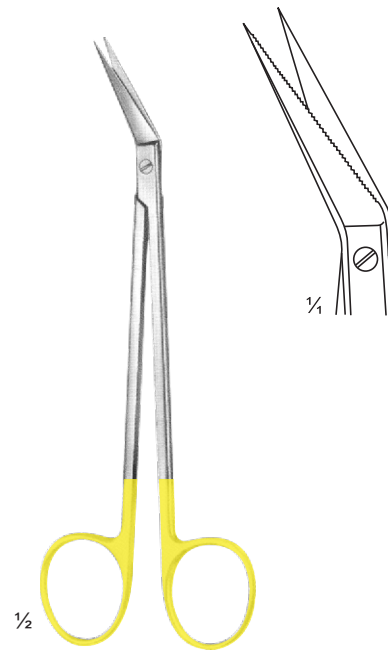

LOCKLIN
JJ-02-521
160 mm
one toothed cutting edge

SUPER-CUT SCISSORS



MAYO
JJ-02-522 - JJ-02-523
 17.0 cm, 6 3/4"

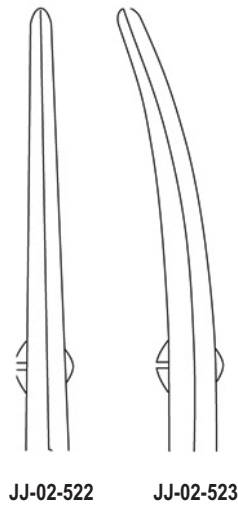

JJ-02-522 **JJ-02-523**

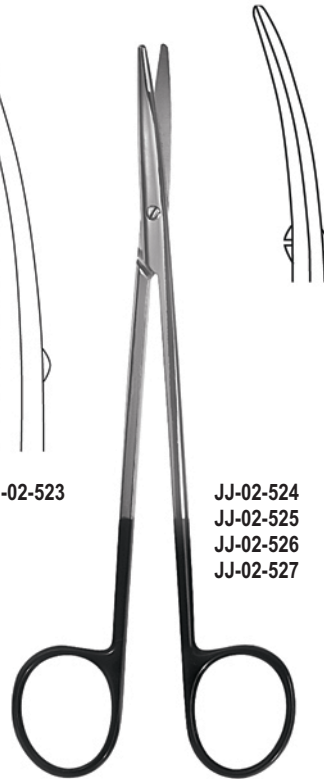

METZENBAUM
JJ-02-524 - JJ-02-527

JJ-02-524 14.5 cm, 5 3/4"
JJ-02-525 18.0 cm, 7"
JJ-02-526 20.0 cm, 8"
JJ-02-527 23.0 cm, 9"

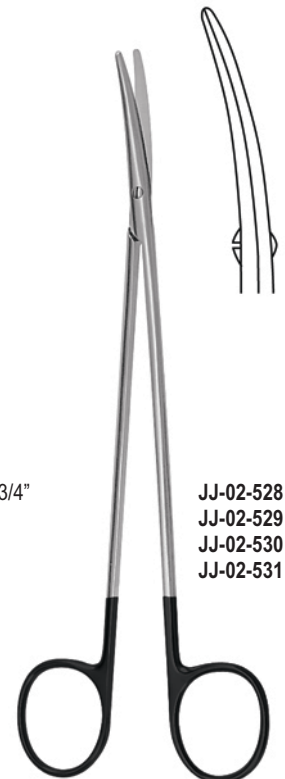

METZENBAUM-FINO
JJ-02-528 - JJ-02-531

JJ-02-528 14.5 cm, 5 3/4"
JJ-02-529 18.0 cm, 7"
JJ-02-530 20.0 cm, 8"
JJ-02-531 23.0 cm, 9"



KAYE FACE LIFT
JJ-02-532 - JJ-02-533

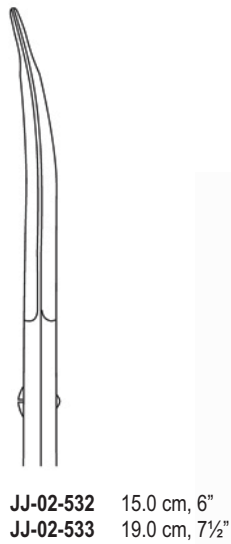

JJ-02-532 15.0 cm, 6"
JJ-02-533 19.0 cm, 7 1/2"



JABALEY
JJ-02-534
 13.0 cm, 5"



ENDARTERECTOMY
JJ-02-535
 18.0 cm, 7"



TOENNIS-ADSON
JJ-02-536
 17.0 cm, 6 3/4"



STRABISMUS
JJ-02-537 - JJ-02-538
11.5 cm, 4 1/2"



JAMISON
JJ-02-539 15.0 cm, 6"
JJ-02-540 18.0 cm, 7"



REYNOLDS
JJ-02-541
12.5 cm, 5"



BABY-METZENBAUM
JJ-02-542 11.0 cm, 4 3/8"
JJ-02-543 14.5 cm, 5 3/4"



IRIS
JJ-02-544
11.0 cm, 4 3/8"



IRIS
JJ-02-545
11.0 cm, 4 3/8"



STEVENS TENOTOMY
JJ-02-546
11.0 cm, 4 3/8"



STEVENS TENOTOMY
JJ-02-547
11.0 cm, 4 3/8"

SUPER-CUT SCISSORS



PAR TYPE
JJ-02-548
 12.0 cm, 4 3/4"



PAR TYPE
JJ-02-549
 12.0 cm, 4 3/4"



POTTS
JJ-02-550 - JJ-02-552
 19.0 cm, 7 1/2"

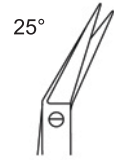

JJ-02-550

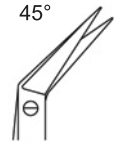

JJ-02-551

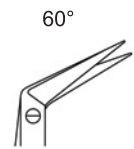

JJ-02-552



JJ-02-553
 14.5 cm, 5 3/4"

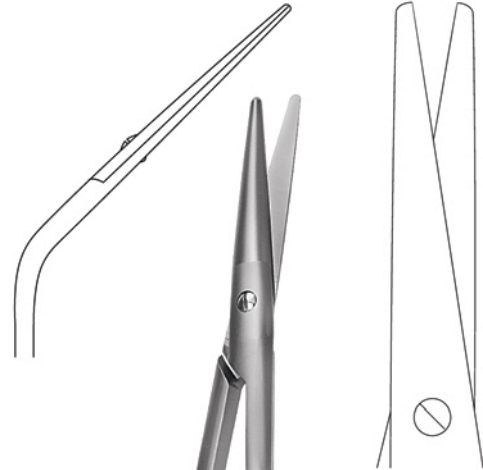

COTTLE
JJ-02-554
 16.5 cm, 6 1/2"



JJ-02-555
14.5 cm



JJ-02-556
18 cm



JJ-02-557
20.5 cm

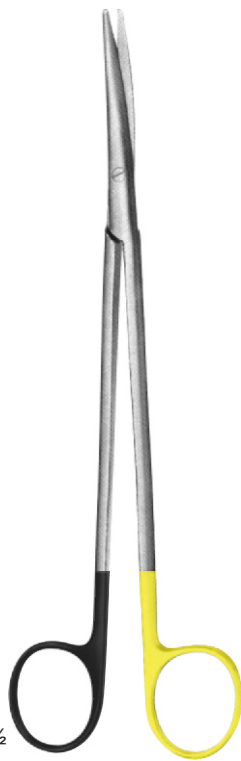

1/2



1/4

JJ-02-558
23 cm



JJ-02-559
25 cm



JJ-02-560
30 cm

LIGATURE SCISSORS
JJ-02-555 - JJ-02-560
for synthetic suture material,
one toothed cutting edge

LIGATURE SCISSORS WITH TUNGSTEN CARBIDE AND SUPER-CUT EDGES



1/2

LIGATURE SCISSORS
JJ-02-561 - JJ-02-563
for synthetic suture material,
one toothed cutting edge



1/4

JJ-02-561
14.5 cm



JJ-02-562
17 cm



JJ-02-563
23 cm

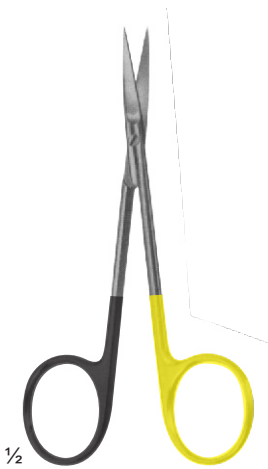

1/2

IRIS
JJ-02-564
11.5 cm



1/4



JJ-02-565
18 cm

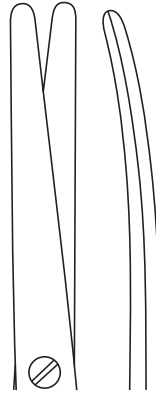

JJ-02-566
20 cm



JJ-02-567
23 cm



JJ-02-568
26 cm

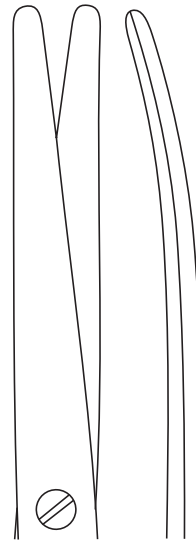

JJ-02-569
28.5 cm



JJ-02-570
31 cm

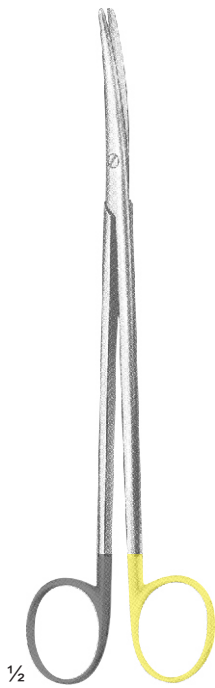

METZENBAUM
JJ-02-565 - JJ-02-570

Page 71-77

- Probes
- Cotton Applicators
- Suture Clips
- Clip Applying Forceps
- Clip Removing Forceps

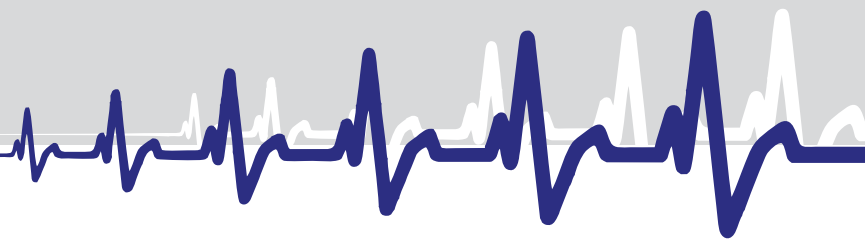

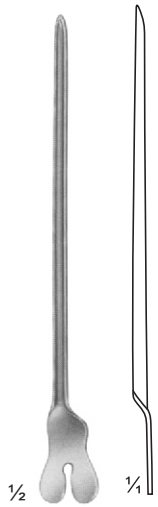

JJ-03-101 130 mm
JJ-03-102 145 mm
JJ-03-103 160 mm
Directors

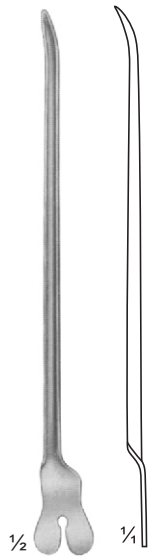

JJ-03-104
DOYEN 145 mm
JJ-03-105
NELATON 160 mm
Directors

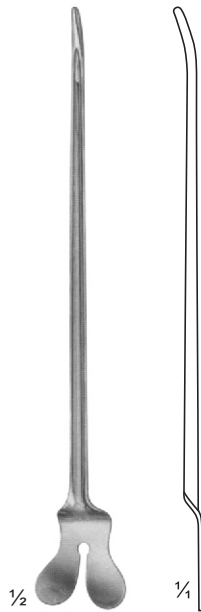

JJ-03-106
Director with tip
Diam. Of tip 3,3 mm
140 mm

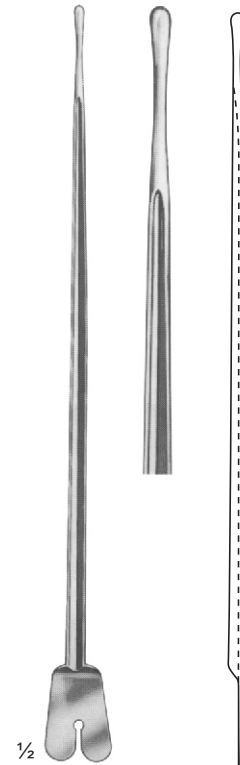

JJ-03-107
BRODIE
Director with tip,
Diam. Of tip 3,5 mm
200 mm

PROBES



JJ-03-108
2,5 mm
JJ-03-109
2,5 mm
JJ-03-110
3,0 mm

JJ-03-108 145 mm
JJ-03-109 160 mm
JJ-03-110 200 mm
Probes with eye



JJ-03-111
Myrtle leaf probe
145 mm



JJ-03-112 130 mm
JJ-03-113 145 mm
JJ-03-114 160 mm
JJ-03-115 180 mm
JJ-03-116 200 mm



JJ-03-117
Probes



JJ-03-118
Double ended probe,
malleable, diam. of tips
3 mm with hole
190 mm



JJ-03-119
Double ended probes,
tin, malleable,
diam. of tips
3,5 mm with hole
250 mm, 300 mm



JJ-03-120
Double ended probes,
tin, malleable,
diam. of tips 4 mm
400 mm



JJ-03-121 1,5 mm
JJ-03-122 2,0 mm
JJ-03-123 2,5 mm
300 mm



JJ-03-124
STACKE
100 mm



JJ-03-125
KILLIAN
165 mm



JJ-03-126
160 mm



JJ-03-127
SEIFFERT
180 mm



German Silver
JJ-03-128
BOWMAN
130 mm



JJ-03-129
SPATULA
145 mm



JJ-03-130
SPATULA
145 mm



JJ-03-131
Modell PICCOLO
Round Serrated
110 mm



JJ-03-132
Modell PICCOLO
Triangular Serrated end
110 mm



JJ-03-133
FARRELL
Round Serrated end
110 mm



JJ-03-134
LATHBURY-FARRELL
Triangular Serrated end
110 mm

COTTON APPLICATORS

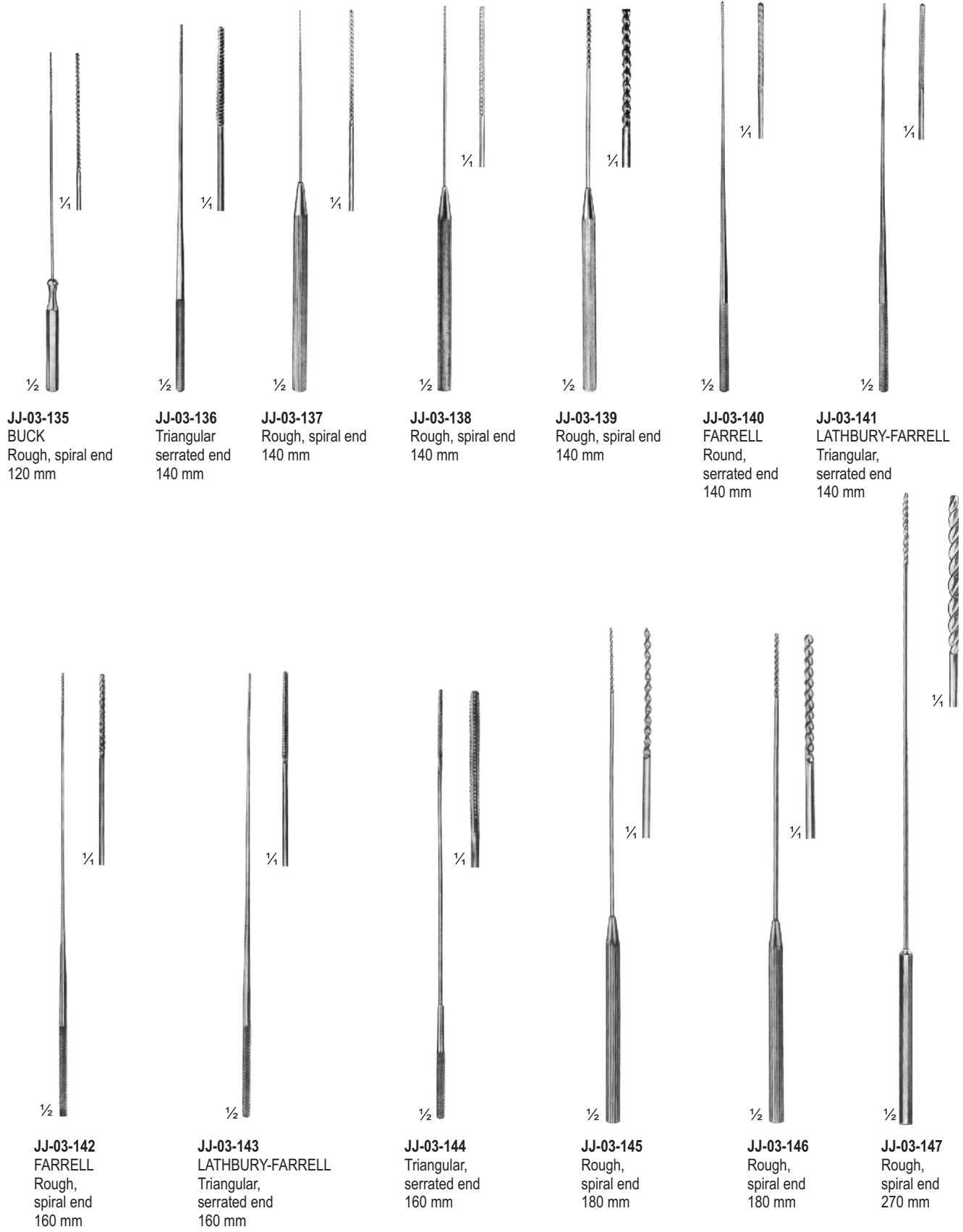



JJ-03-148
MICHEL
125 mm



JJ-03-149
HEGENBARTH
120 mm



JJ-03-150
WACHENFELDT
120 mm



JJ-03-151
WACHENFELDT
120 mm



JJ-03-152
MICHEL
125 mm



JJ-03-153
MICHEL modif.
130 mm



JJ-03-154
HEATH
135 mm

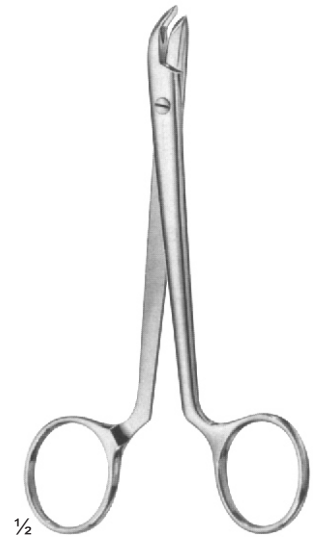

JJ-03-155
COLLIN
135 mm

REDON - GUIDE NEEDLES

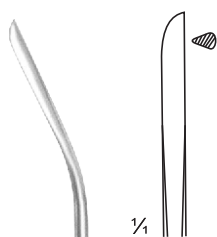

- JJ-03-156 8 CH
- JJ-03-157 10 CH
- JJ-03-158 12 CH
- JJ-03-159 14 CH
- JJ-03-160 16 CH
- JJ-03-161 18 CH

1/2

REDON
JJ-03-156 - JJ-03-161
threaded end
19.5 cm

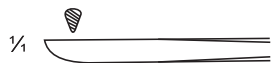

- JJ-03-162 8 CH
- JJ-03-163 10 CH
- JJ-03-164 12 CH
- JJ-03-165 14 CH
- JJ-03-166 16 CH
- JJ-03-167 18 CH

1/2

REDON
JJ-03-162 - JJ-03-167
threaded end
14 cm

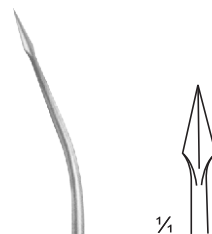

- JJ-03-168 8 CH
- JJ-03-169 10 CH
- JJ-03-170 12 CH
- JJ-03-171 14 CH
- JJ-03-172 16 CH
- JJ-03-173 18 CH

1/2

REDON
JJ-03-168 - JJ-03-173
threaded end
19.5 cm



- JJ-03-174 8 CH
- JJ-03-175 10 CH
- JJ-03-176 12 CH
- JJ-03-177 14 CH
- JJ-03-178 16 CH
- JJ-03-179 18 CH

1/2

REDON
JJ-03-174 - JJ-03-179
threaded end
19.5 cm



NABATOFF
JJ-03-180
135x100x25 mm



JJ-03-181



JJ-03-182
Ø 3 mm



JJ-03-183
Ø 6 mm



JJ-03-187



JJ-03-184
Ø 9 mm



JJ-03-185
Ø 12 mm



JJ-03-186
Ø 15 mm

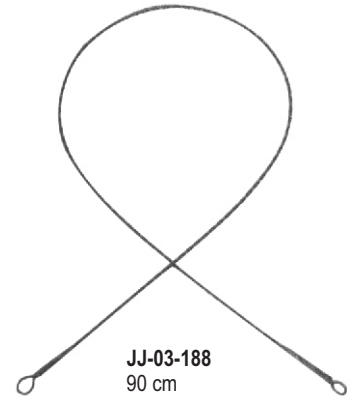

JJ-03-188
90 cm



MYERS
JJ-03-189



JJ-03-190
Ø 6 mm



JJ-03-191
Ø 9 mm



JJ-03-192
Ø 12 mm



JJ-03-193
Ø 15 mm



VARADY
JJ-03-194



JJ-03-195



JJ-03-196



JJ-03-197

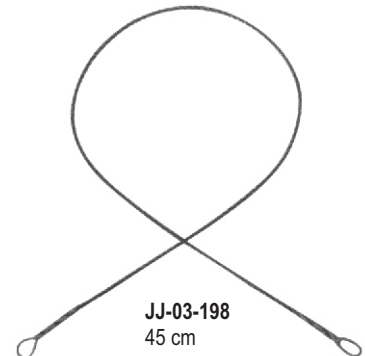

JJ-03-198
45 cm

Page 78–102

- Self-Retaining Retractors
- Abdominal Retractors

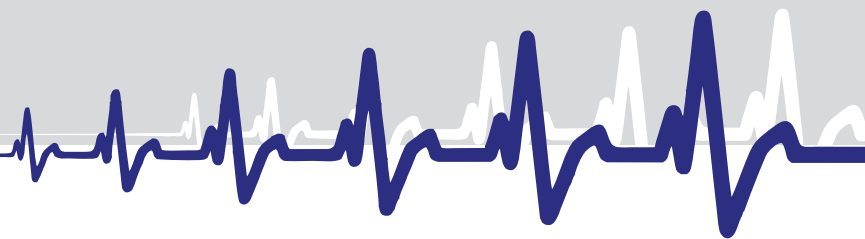

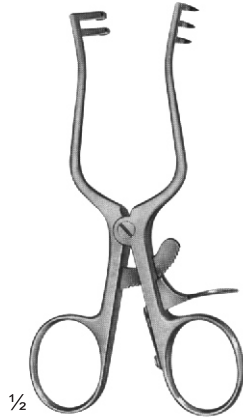

JJ-04-101
WEITLANER
Sharp
110 mm

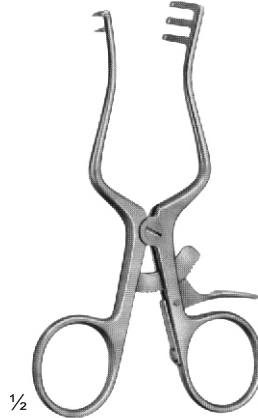

JJ-04-102
WEITLANER
Semi-Sharp
110 mm

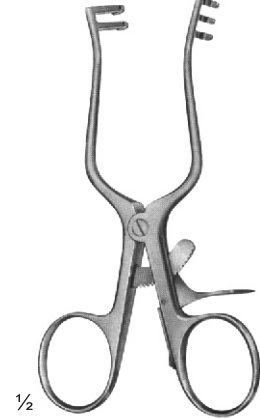

JJ-04-103
WEITLANER
Blunt
110 mm

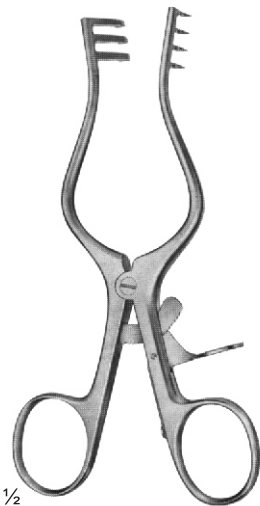

JJ-04-104
WEITLANER
Sharp
130 mm

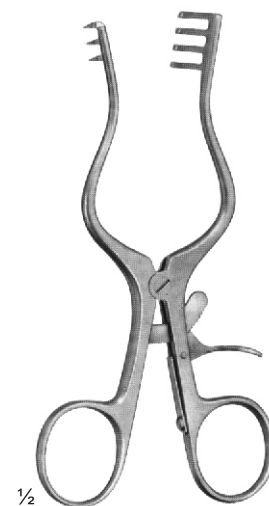

JJ-04-105
WEITLANER
Semi-Sharp
130 mm

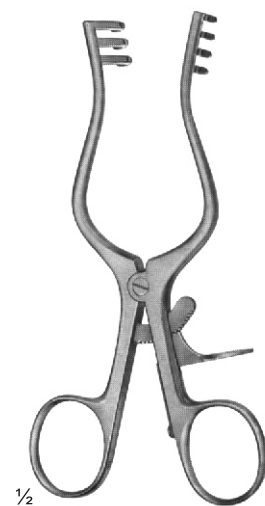

JJ-04-106
WEITLANER
Blunt
130 mm

SELF-RETAINING RETRACTORS

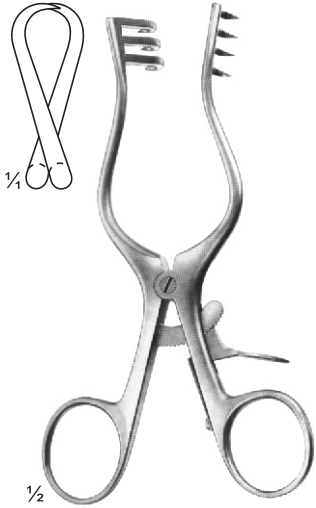

JJ-04-107
WEITLANER
Sharp
130 mm

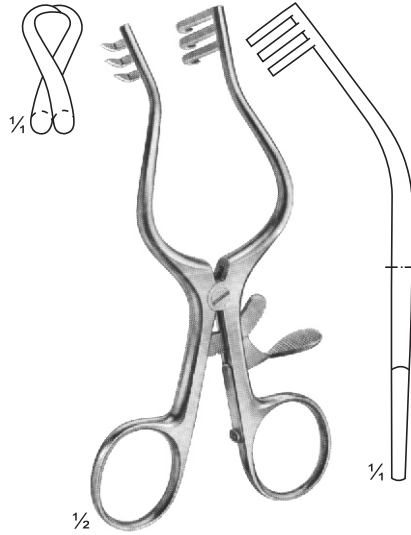

JJ-04-108
WULLSTEIN
Sharp
130 mm

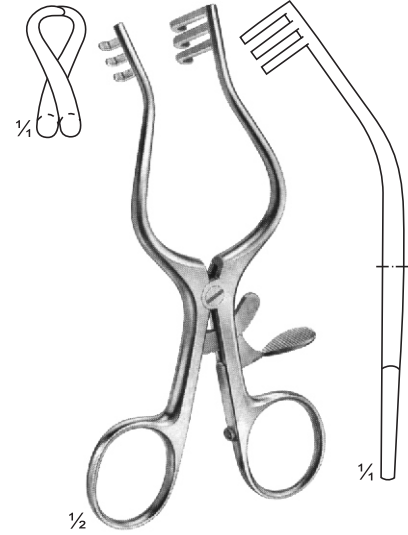

JJ-04-109
WULLSTEIN
Blunt
130 mm



JJ-04-110
WEITLANER
Sharp
165 mm



JJ-04-111
PLESTER
Blunt
110 mm

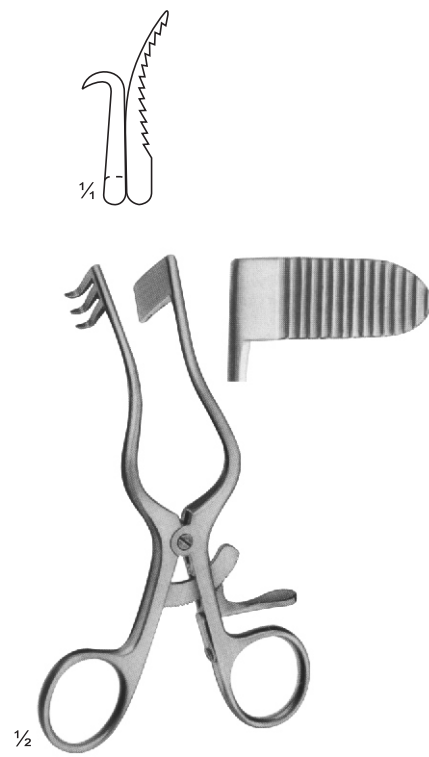

JJ-04-112
PERKINS
Blunt
130 mm



JJ-04-113
ADSON-BABY
Blunt
140 mm

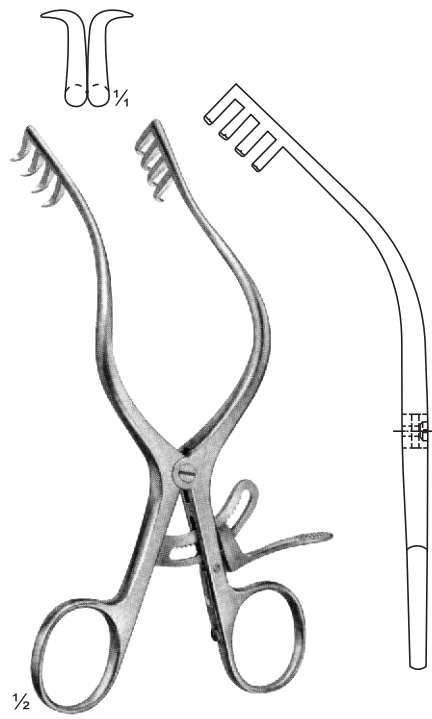

JJ-04-114
MOLLISON
Sharp
155 mm

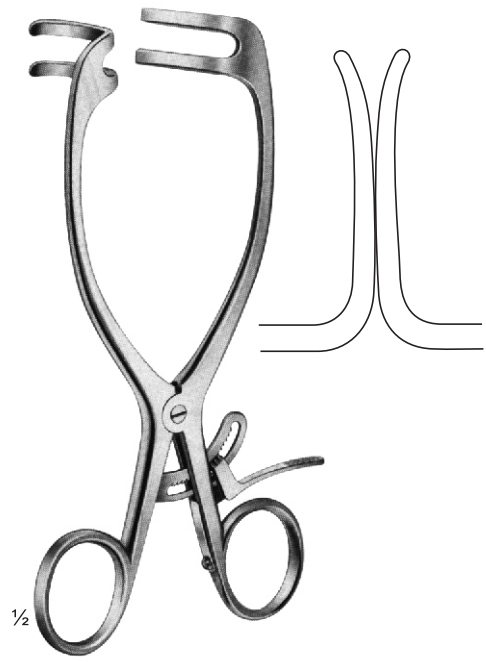

JJ-04-115
MAYO-ADAMS
165 mm

SELF-RETAINING LAMINECTOMY RETRACTORS

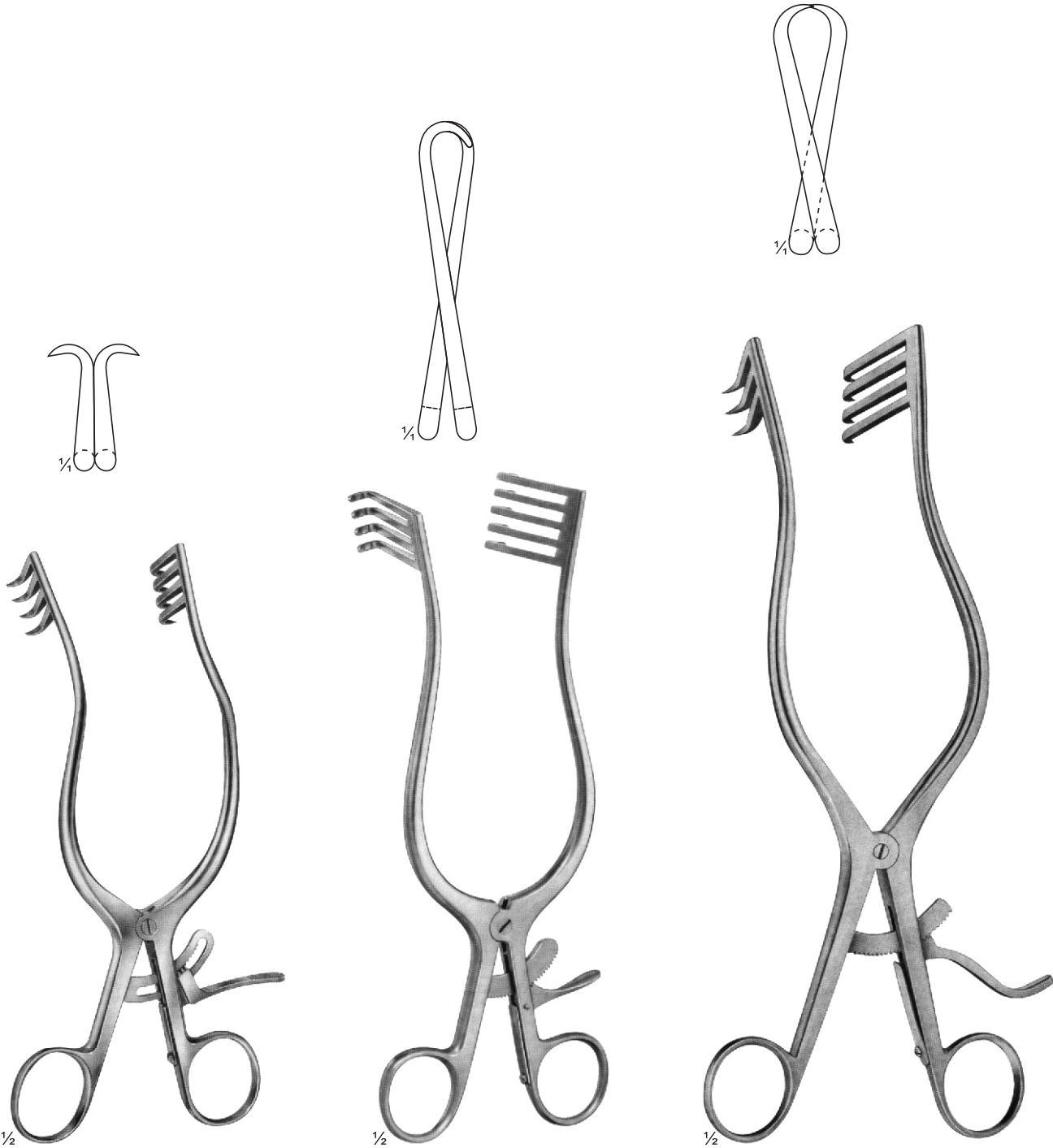

JJ-04-116
ANDERSON-ADSON
 Sharp
 190 mm

JJ-04-117
NORFOLK and
NORWICH
 Blunt
 220 mm

JJ-04-118
ADSON
 Sharp
 265 mm

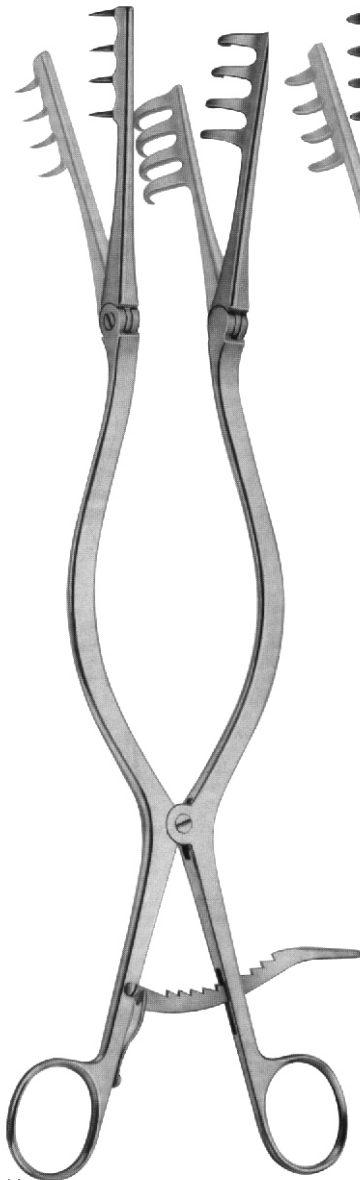
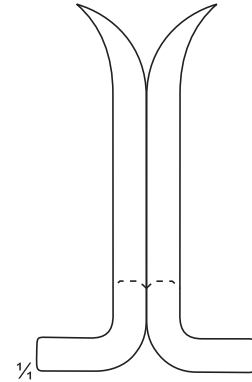
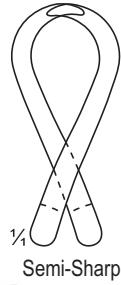
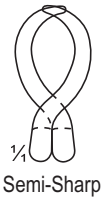
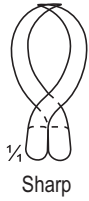

1/2
JJ-04-119
BECKMANN-ADSON
Sharp
310 mm

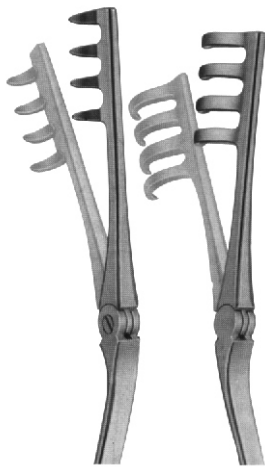

JJ-04-119A
BECKMANN-ADSON
Semi-Sharp
310 mm

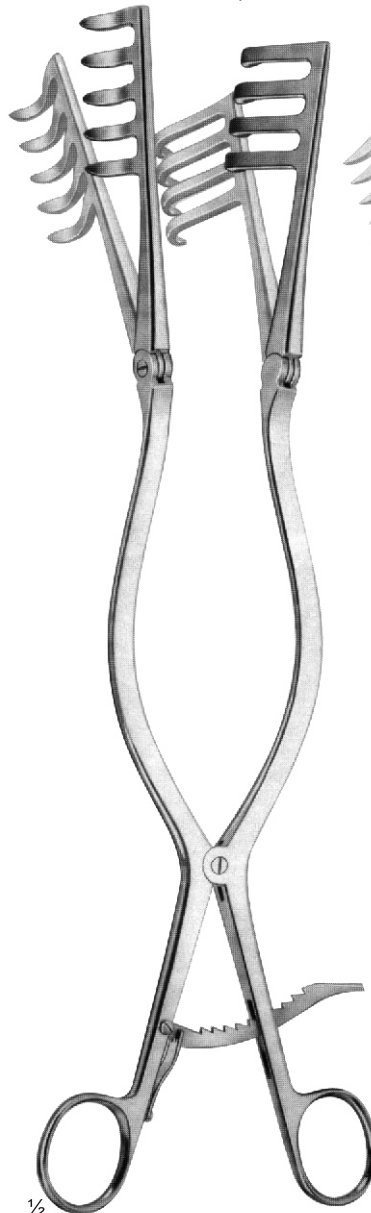

1/2
JJ-04-120
ADSON
Semi-Sharp
320 mm



1/2
JJ-04-121
BECKMANN-EATON
Sharp
320 mm

SPECIAL RETRACTORS

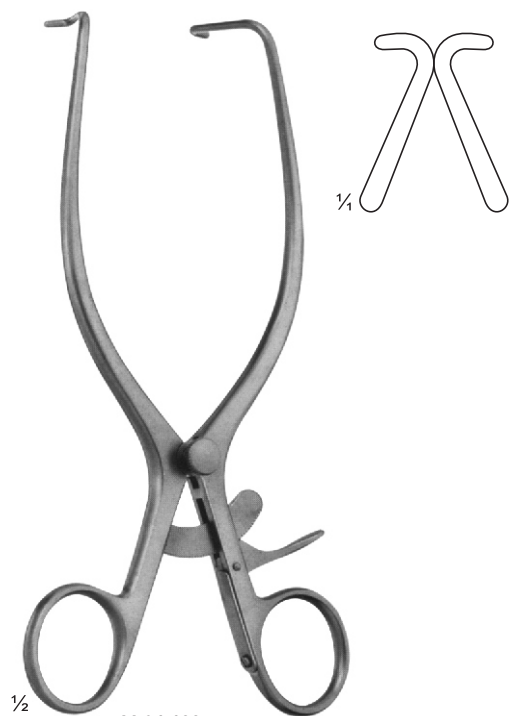

JJ-04-122
JACKSON BURROWS
Retractor, blunt
185 mm



JJ-04-123
GELPI
Vaginal Retractor
135 mm



JJ-04-124
GELPI
Skin- and Vaginal Retractor
175 mm



JJ-04-125
DE BAKEY
Femur Retractor
145 mm

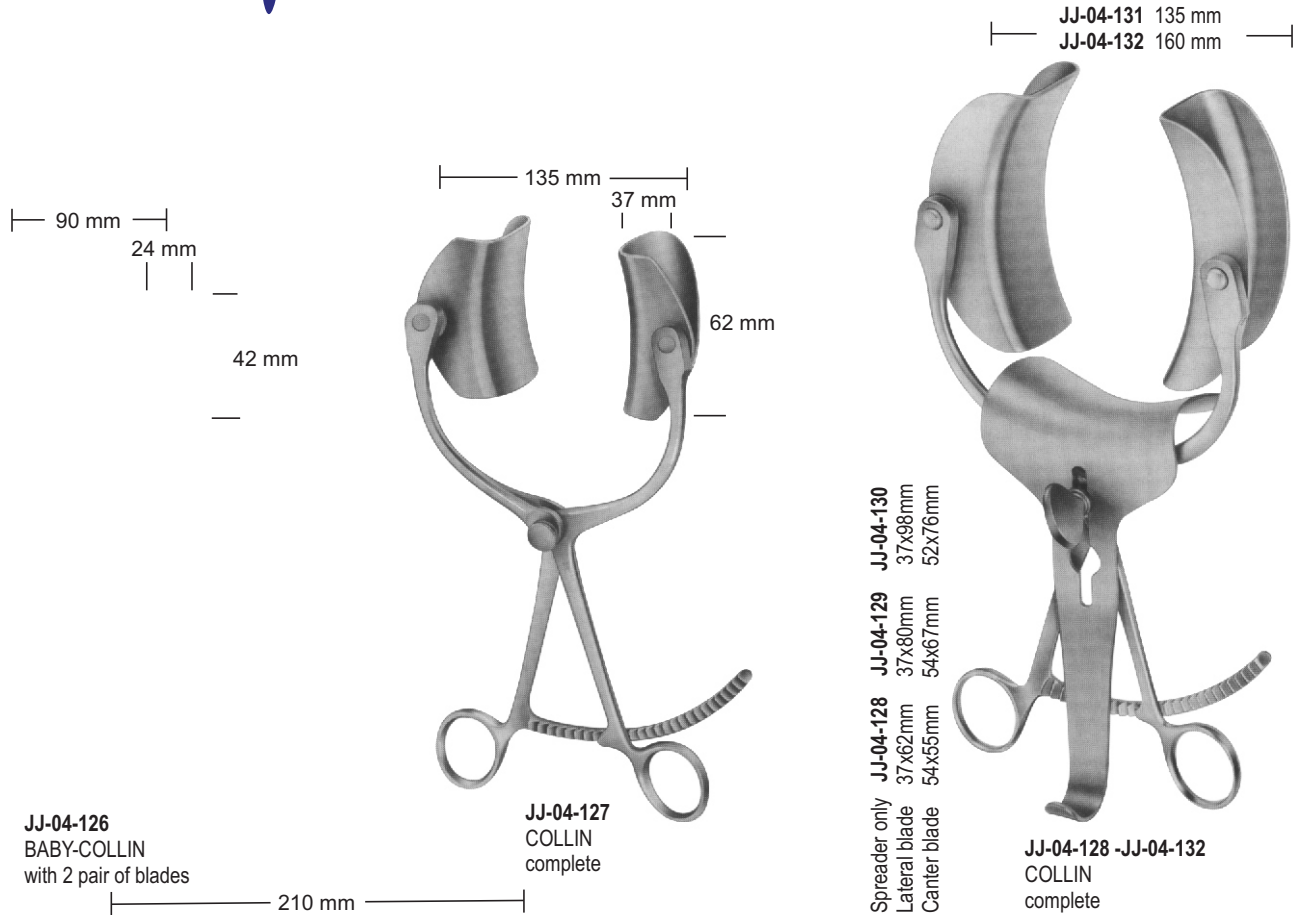

Spreader only **JJ-04-133** **JJ-04-134**
Lateral blade 58x80mm 72x84mm
Canter blade 54x70mm 72x90mm



JJ-04-135 Spreader only
JJ-04-136 Lateral blade 59x80mm
JJ-04-137 Canter blade 74x82mm

ABDOMINAL RETRACTORS

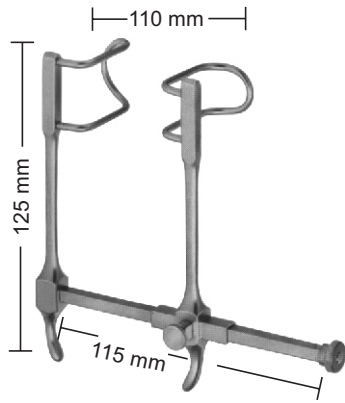

JJ-04-138
GOSSET
Blades:38 mm deep

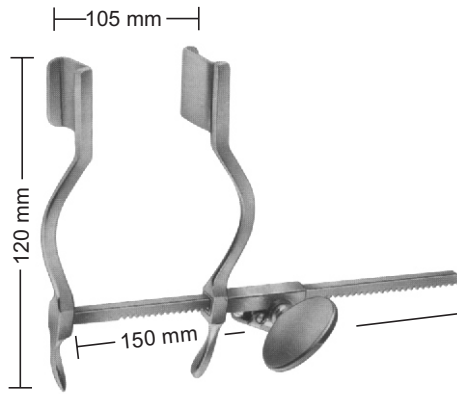

JJ-04-139
HERTZLER
Blades 20 X 25 mm

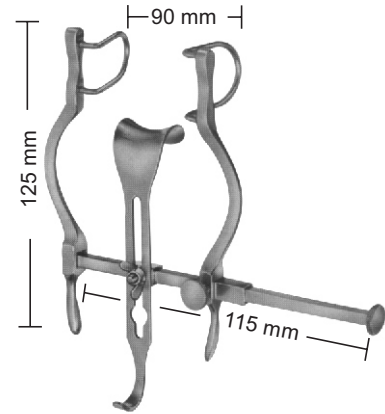

JJ-04-140
BALFOUR-BABY
Lateral blades 27 mm deep
Center blade 21x24 mm

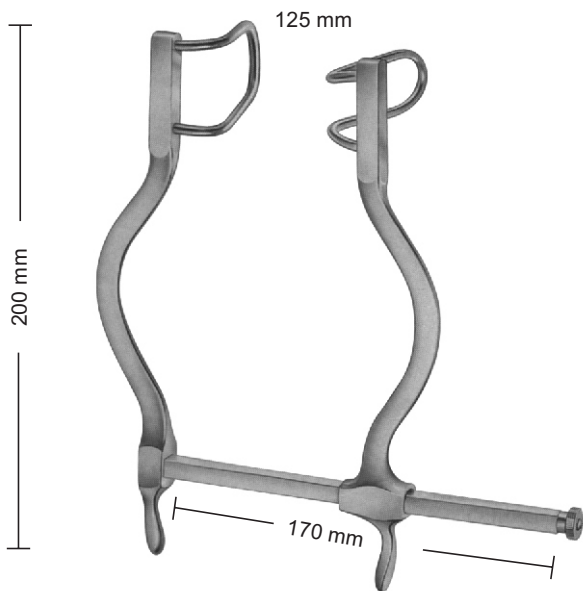

JJ-04-141
GOSSET
Blades:55mm deep

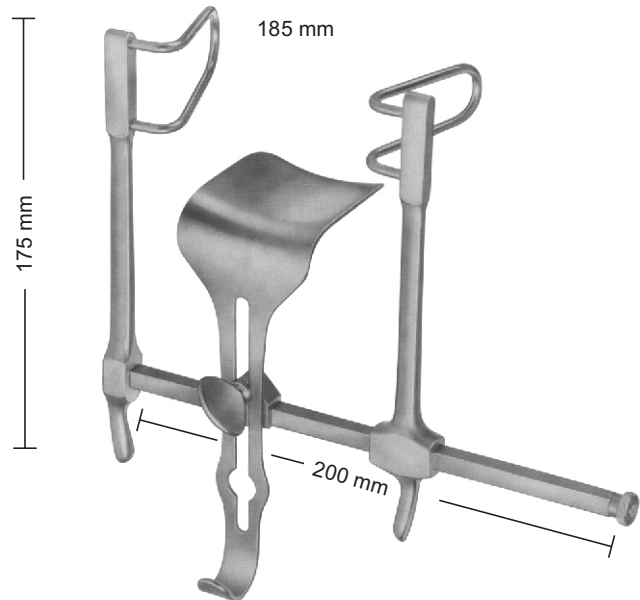

JJ-04-142
GOSSET
Lateral blades 58 mm deep
Center blade 59 x 57 mm

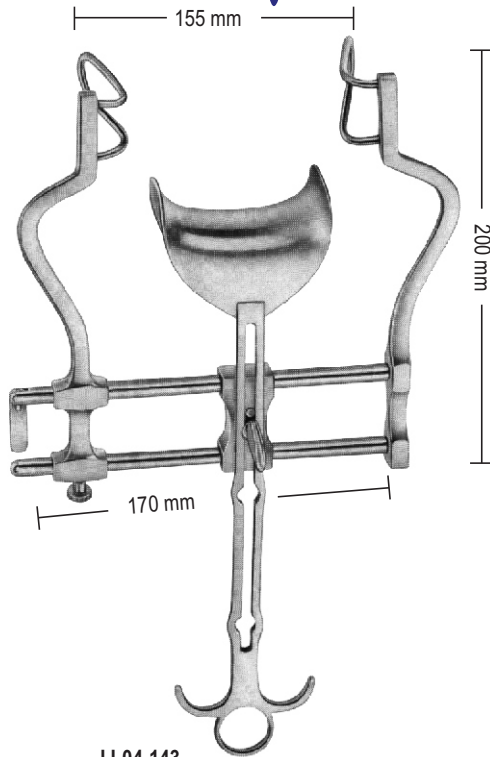

JJ-04-143
BALFOUR
Lateral blades 60 mm deep
Center blade 47 x 80 mm

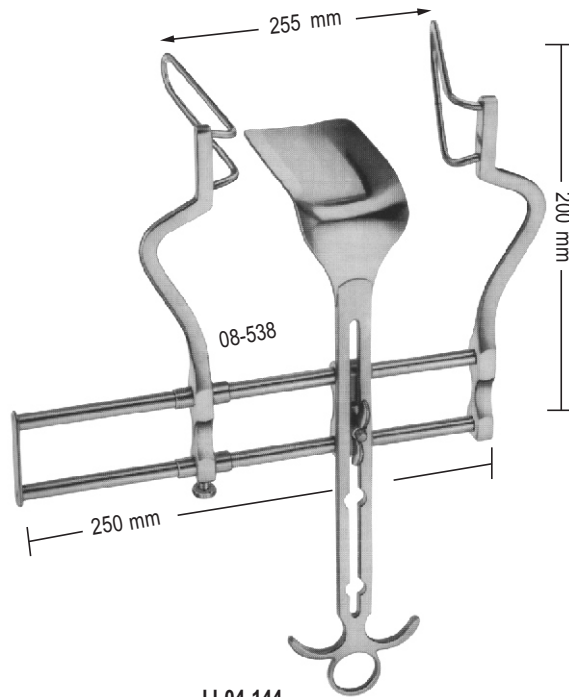

JJ-04-144
BALFOUR
Lateral blades 105 mm deep
Center blade 107x 59 mm

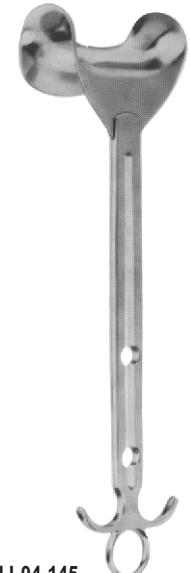

JJ-04-145
Center blade only
54x80 mm

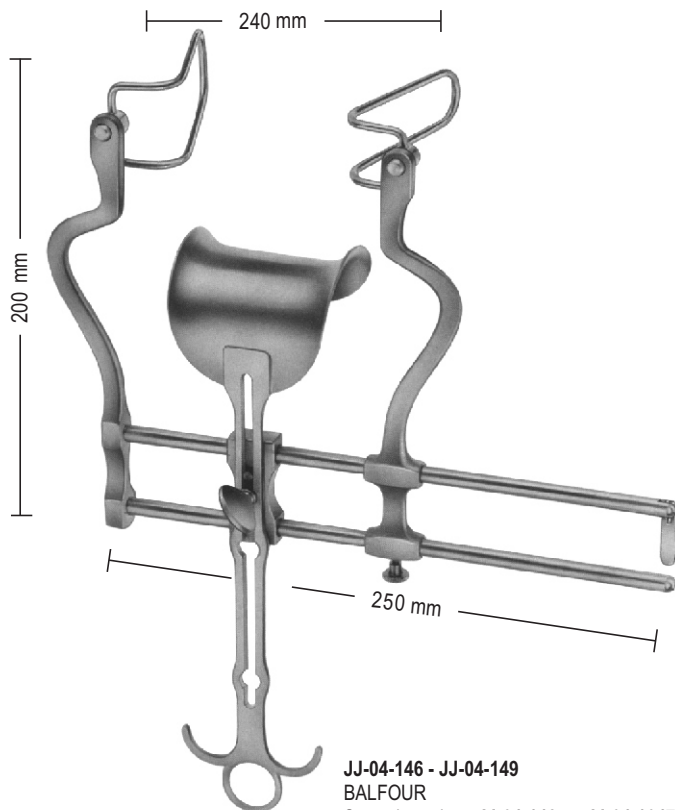

JJ-04-146 - JJ-04-149
BALFOUR
Spreader only **JJ-04-146** **JJ-04-1047** **JJ-04-148** **JJ-04-149**
Lateral blades 50 mm 60 mm 75 mm 90 mm
Center blade 47 x 80 mm 62x76 mm 80x80 mm 80x80 mm

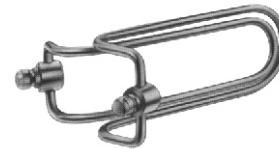

Sales Unit of blades:PR = pair

Lateral blades
JJ-04-150
50 mm deep
JJ-04-151
60 mm deep
JJ-04-152
75 mm deep
JJ-04-153
90 mm deep

WOUND SPREADERS, SELF-RETAINING



BOSE
JJ-04-154
60 mm



FINSEN
JJ-04-155
50 mm



FINSEN
JJ-04-156
70 mm



FINSEN modif.
JJ-04-157
75 mm



JJ-04-158
45 mm



JJ-04-159
55 mm



MUELLER
JJ-04-160
65 mm



ALM
JJ-04-161 7 cm
JJ-04-162 10 cm



JJ-04-161



JJ-04-162

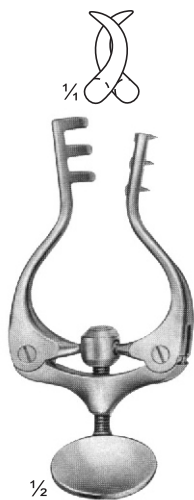

JANSEN
JJ-04-163
100 mm

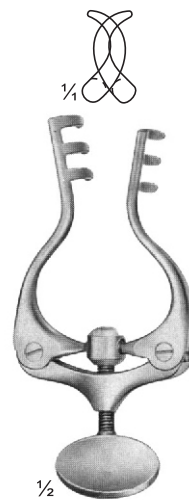

JANSEN
JJ-04-164
100 mm



ADSON-BABY
Blunt
JJ-04-165
14 cm

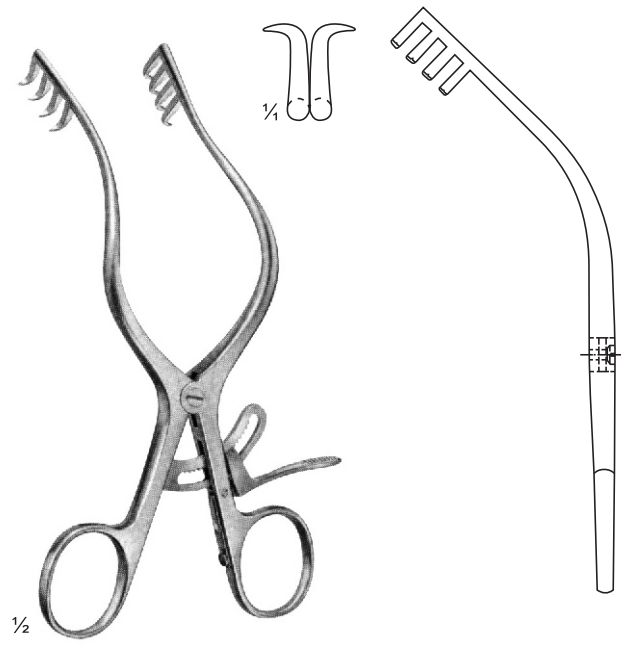

MOLLISON
Sharp
JJ-04-166
15.5 cm

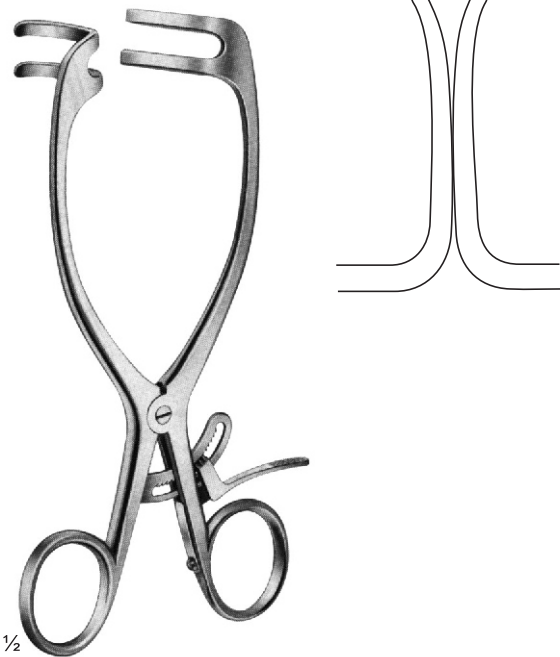

MAYO-ADAMS
JJ-04-167
16.5 cm



TRAVERS
JJ-04-168
21.5 cm

SELF RETAINING RETRACTORS FOR LAMINECTOMY AND OTHER OPERATIONS

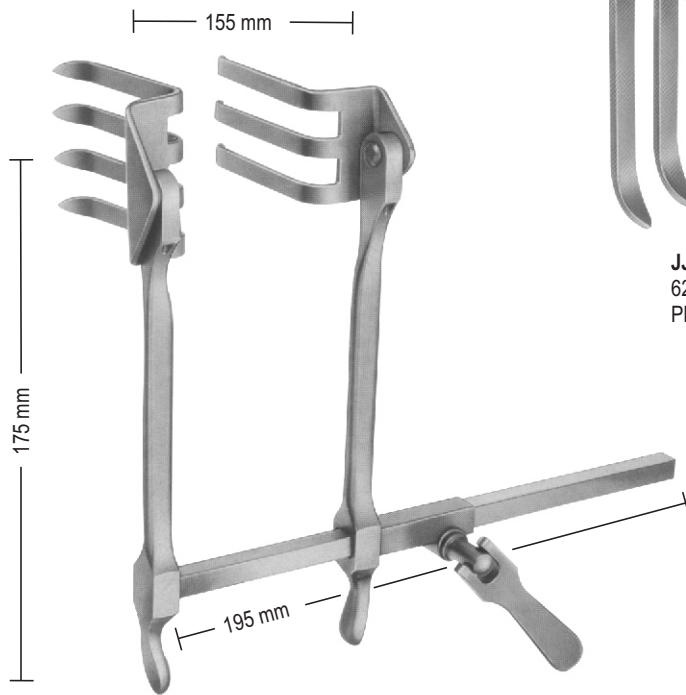

JJ-04-169 - JJ-04-172
 SCOVILLE-RICHTER
 Retractor with 1 pair
 blades reversible type.
 The Retractor bar and
 shanks may be easily
 rotated 180 when
 blades are in situ.



JJ-04-169
 62 x 52 mm 62 x 37 mm
 PR= Pair



JJ-04-170
 47 x 51 mm



JJ-04-171
 30 x 40 mm



JJ-04-172
 37 x 62 mm

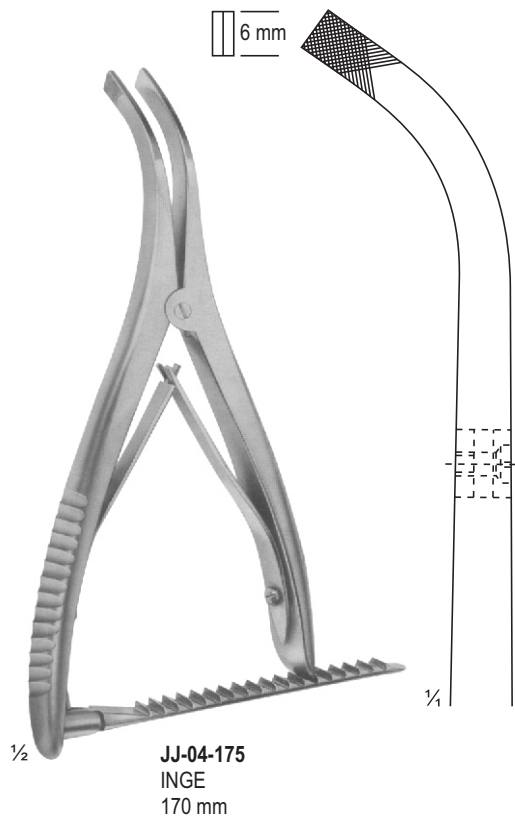
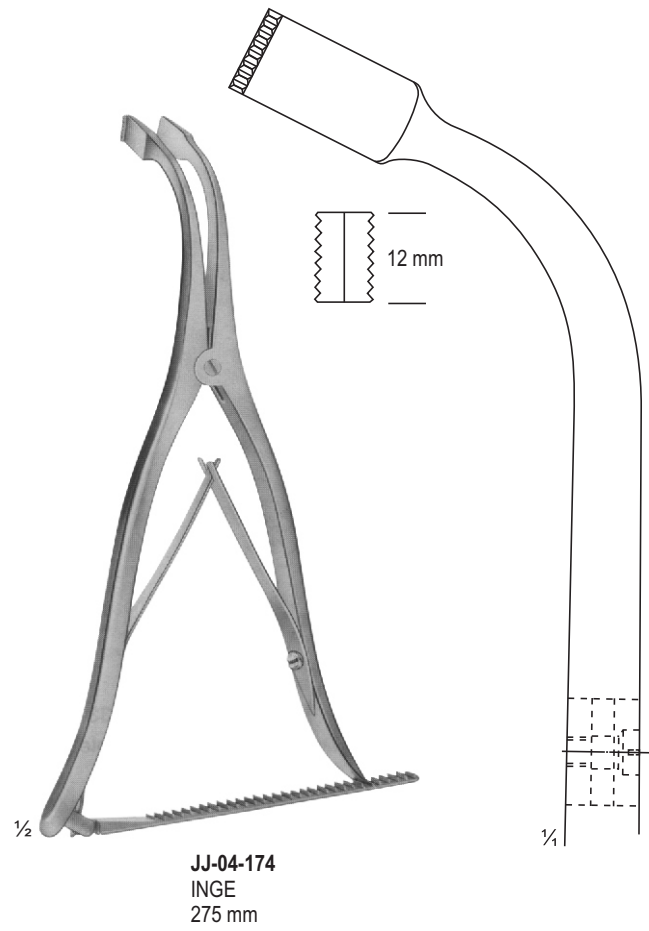
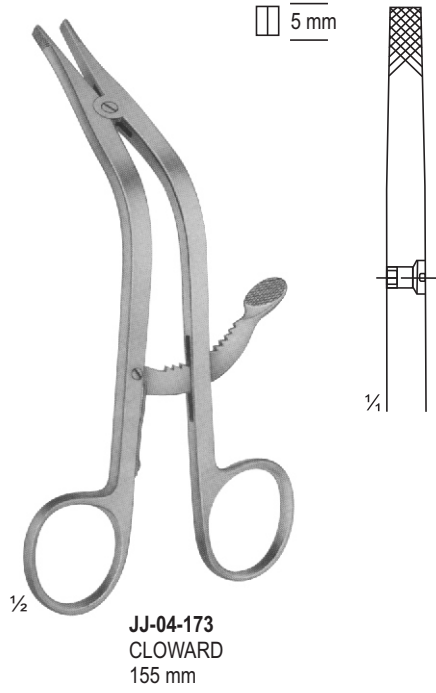

SELF-RETAINING RETRACTORS

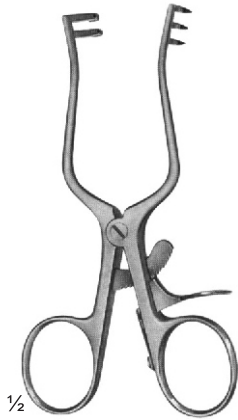

WEITLANER
Sharp
JJ-04-176
11 cm

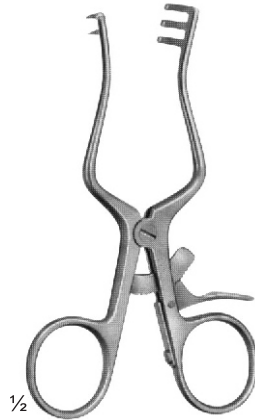

WEITLANER
Semi-Sharp
JJ-04-177
11 cm

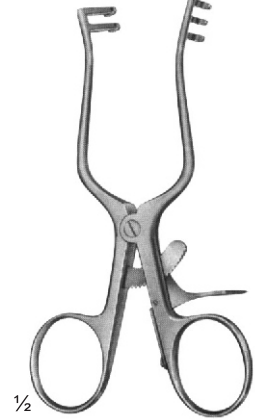

WEITLANER
Blunt
JJ-04-178
11 cm

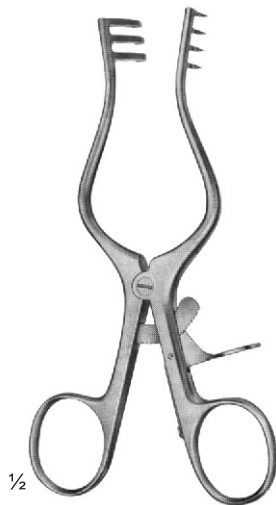

WEITLANER
Sharp
JJ-04-179
13 cm

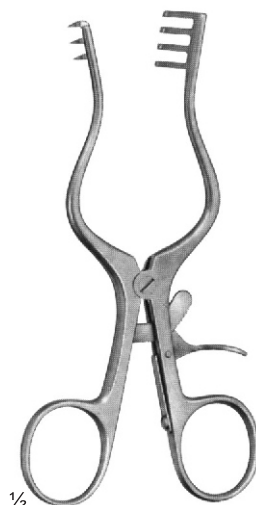

WEITLANER
Semi-Sharp
JJ-04-180
13 cm

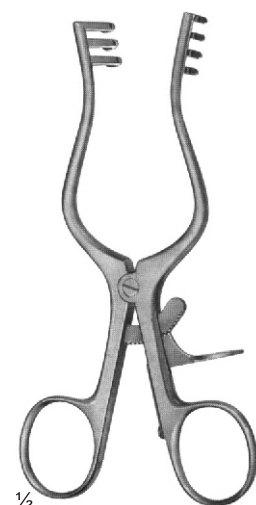

WEITLANER
Blunt
JJ-04-181
13 cm

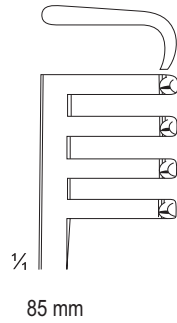

HENLEY
Complete with 3 Central Baldes
JJ-04-182 - JJ-04-184
16.5 cm

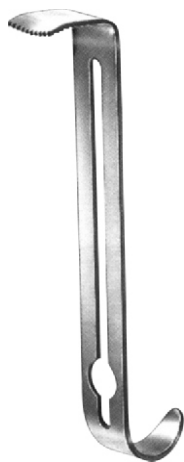

Blades
JJ-04-182
19 X 17 mm

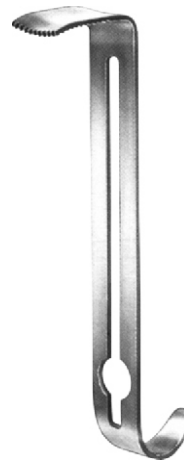

Blades
JJ-04-183
25 X 17 mm

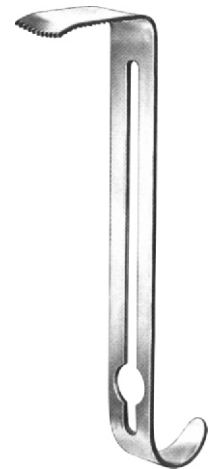

Blades
JJ-04-184
32 X 17 mm

SPECIAL RETRACTORS



1/2

JOLL (FRIEDMAN)
JJ-04-185
 Thyroid and Vaginal Retractor
 15.5 cm

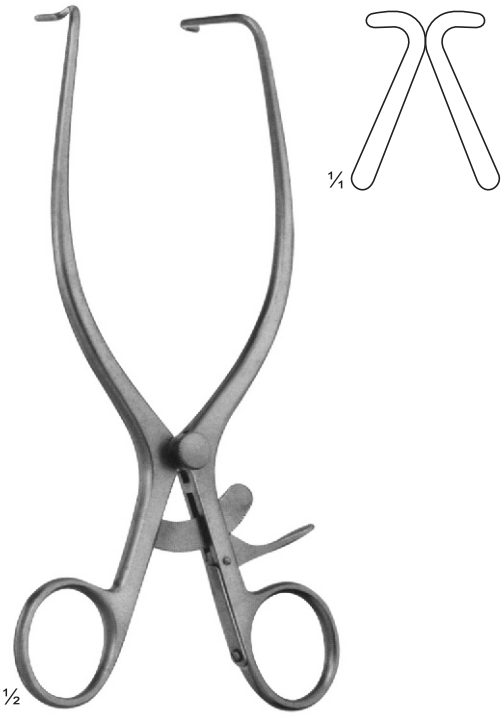

1/4

1/2

JACKSON BURROWS
JJ-04-186
 Retractor, blunt
 18.5 cm

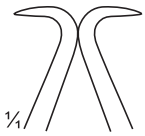

1/4



1/2

GELPI
JJ-04-187
 13.5 cm

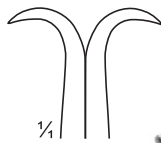

1/4



1/2

GELPI
JJ-04-188
 17.5 cm

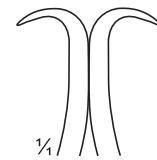

1/4



1/2

DE BAKEY
JJ-04-189
 14.5 cm

½

O'SULLIVAN-O'CONNOR
JJ-04-190 - JJ-04-192



1

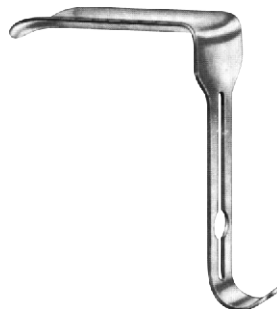

2



3

Blades for
Fig. 1 = **JJ-04-190** 45 X 17 mm
Fig. 2 = **JJ-04-191** 90 X 37 mm
Fig. 3 = **JJ-04-192** 90 X 45 mm

RETRACTORS FOR CERVICAL SPINE



CLOWARD modif.
Spreader Only
JJ-04-193 - JJ-04-202

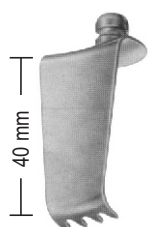

16 mm
JJ-04-193

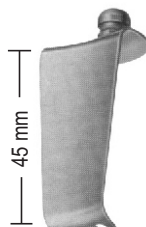

16 mm
JJ-04-194

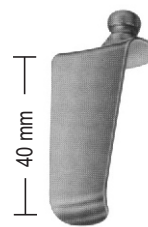

16 mm
JJ-04-195

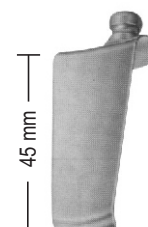

16 mm
JJ-04-196

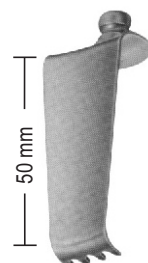

16 mm
JJ-04-197

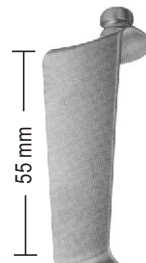

16 mm
JJ-04-198

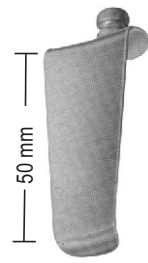

16 mm
JJ-04-199

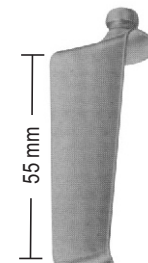

16 mm
JJ-04-200

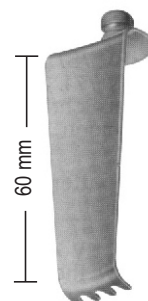

16 mm
JJ-04-201

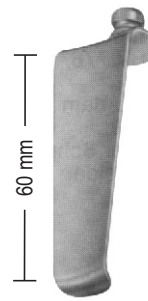

16 mm
JJ-04-202



CLOWARD-TYPE
JJ-04-203
 25.5 cm
 with ball snap closure Cervical Retractor
 complete consisting of Retractor Body
 25.5 cm, 110 mm spread (without blades)



JJ-04-204 - JJ-04-208
JJ-04-204 15 x 40 mm
JJ-04-205 15 x 45 mm
JJ-04-206 15 x 50 mm
JJ-04-207 15 x 55 mm
JJ-04-208 15 x 60 mm
 serrated



JJ-04-209 - JJ-04-213
JJ-04-209 15 x 40 mm
JJ-04-210 15 x 45 mm
JJ-04-211 15 x 50 mm
JJ-04-212 15 x 55 mm
JJ-04-213 15 x 60 mm
 Blunt

RETRACTORS FOR CERVICAL VERTEBRAL COLUMN

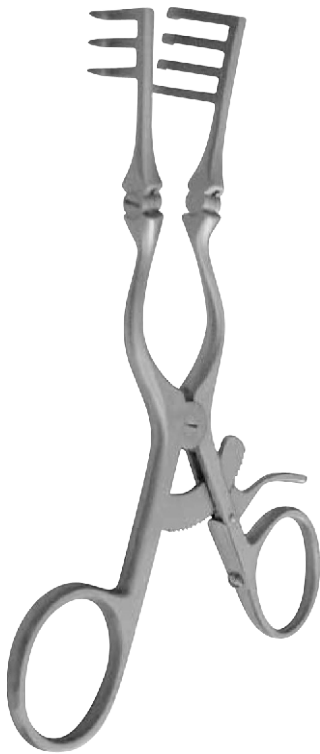

CONE

JJ-04-214 - JJ-04-221

JJ-04-214 14 cm, 18 mm 3 x 4

JJ-04-215 16 cm, 18 mm 3 x 4

JJ-04-216 20 cm, 20 mm 3 x 4

JJ-04-217 24 cm, 27 mm 3 x 4

JJ-04-218 14 cm, 18 mm 3 x 4

JJ-04-219 16 cm, 18 mm 3 x 4

JJ-04-220 20 cm, 20 mm 3 x 4

JJ-04-221 24 cm, 27 mm 3 x 4

prongs blunt



MARKHAM-MEYERDING

JJ-04-222

18 cm, 50 x 25 mm left

Hemilaminectomy Retractor



MARKHAM-MEYERDING

JJ-04-223

18 cm, 50 x 25 mm right

Hemilaminectomy Retractor



MINI-WEITLANER

JJ-04-224 - JJ-04-225

JJ-04-224 11 cm, 16 mm 2 x 3 prongs sharp

JJ-04-225 11 cm, 16 mm 2 x 3 prongs blunt



WEITLANER

JJ-04-226 - JJ-04-233

JJ-04-226 13 cm, 18 mm 3 x 4 prongs sharp

JJ-04-227 16 cm, 18 mm 3 x 4 prongs sharp

JJ-04-228 20 cm, 21 mm 3 x 4 prongs sharp

JJ-04-229 25 cm, 27 mm 3 x 4 prongs sharp

JJ-04-230 13 cm, 18 mm 3 x 4 prongs blunt

JJ-04-231 16 cm, 18 mm 3 x 4 prongs blunt

JJ-04-232 20 cm, 21 mm 3 x 4 prongs blunt

JJ-04-233 25 cm, 27 mm 3 x 4 prongs blunt



ANDERSON-ADSON

Cerebellar Retractor

JJ-04-234 20 cm 4 x 4 prongs sharp

RETRACTORS FOR CERVICAL VERTEBRAL COLUMN



WEITLANER

JJ-04-235 - JJ-04-236

JJ-04-235 26 cm, 27 mm 5 x 6 prongs sharp

JJ-04-236 26 cm, 27 mm 5 x 6 prongs blunt



HEMILAMINECTOMY

JJ-04-237 - JJ-04-238

JJ-04-237 29 cm, 42 mm 6 x 6 prongs sharp

JJ-04-238 29 cm, 42 mm 6 x 6 prongs blunt



JJ-04-239 - JJ-04-242

Right blade 42 mm, left blade 22 mm deep

JJ-04-239 29 cm, 22/42 mm 6 x 6 prongs sharp

JJ-04-240 29 cm, 22/42 mm 6 x 6 prongs blunt

Right blade 22 mm, left blade 42 mm deep

JJ-04-241 29 cm, 22/42 mm 6 x 6 prongs sharp

JJ-04-242 29 cm, 22/42 mm 6 x 6 prongs blunt



SCALP CONTOUR

JJ-04-243 - JJ-04-246

- JJ-04-243** 14 cm, 18 mm 1 x 1 prongs blunt
- JJ-04-244** 14 cm, 18 mm 3 x 3 prongs blunt
- JJ-04-245** 14 cm, 18 mm 3 x 4 prongs sharp
- JJ-04-246** 14 cm, 18 mm 3 x 4 prongs blunt

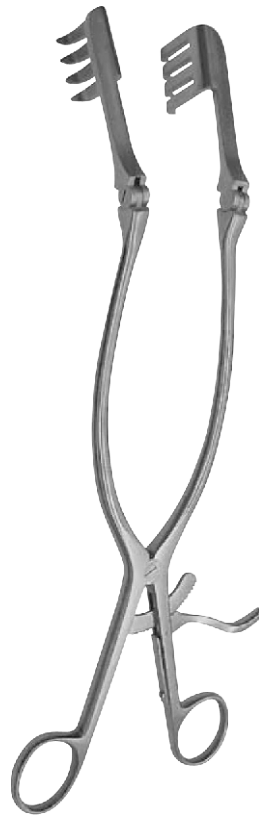

BECKMANN-ADSON

JJ-04-247 - JJ-04-252

- JJ-04-247** 31 cm, 25 mm 4 x 4 prongs sharp
- JJ-04-248** 31 cm, 37 mm 4 x 4 prongs sharp
- JJ-04-249** 31 cm, 48 mm 4 x 4 prongs sharp
- JJ-04-250** 31 cm, 25 mm 4 x 4 prongs blunt
- JJ-04-251** 31 cm, 37 mm 4 x 4 prongs blunt
- JJ-04-252** 31 cm, 48 mm 4 x 4 prongs blunt

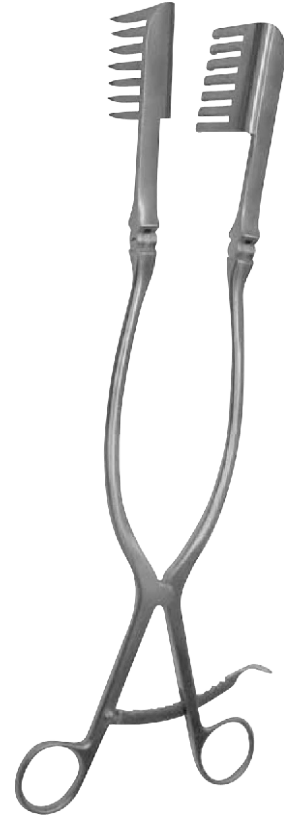

BECKMANN-EATON

JJ-04-253

- 32 cm, 50 mm 7 x 7 prongs sharp

ABDOMINAL RETRACTORS

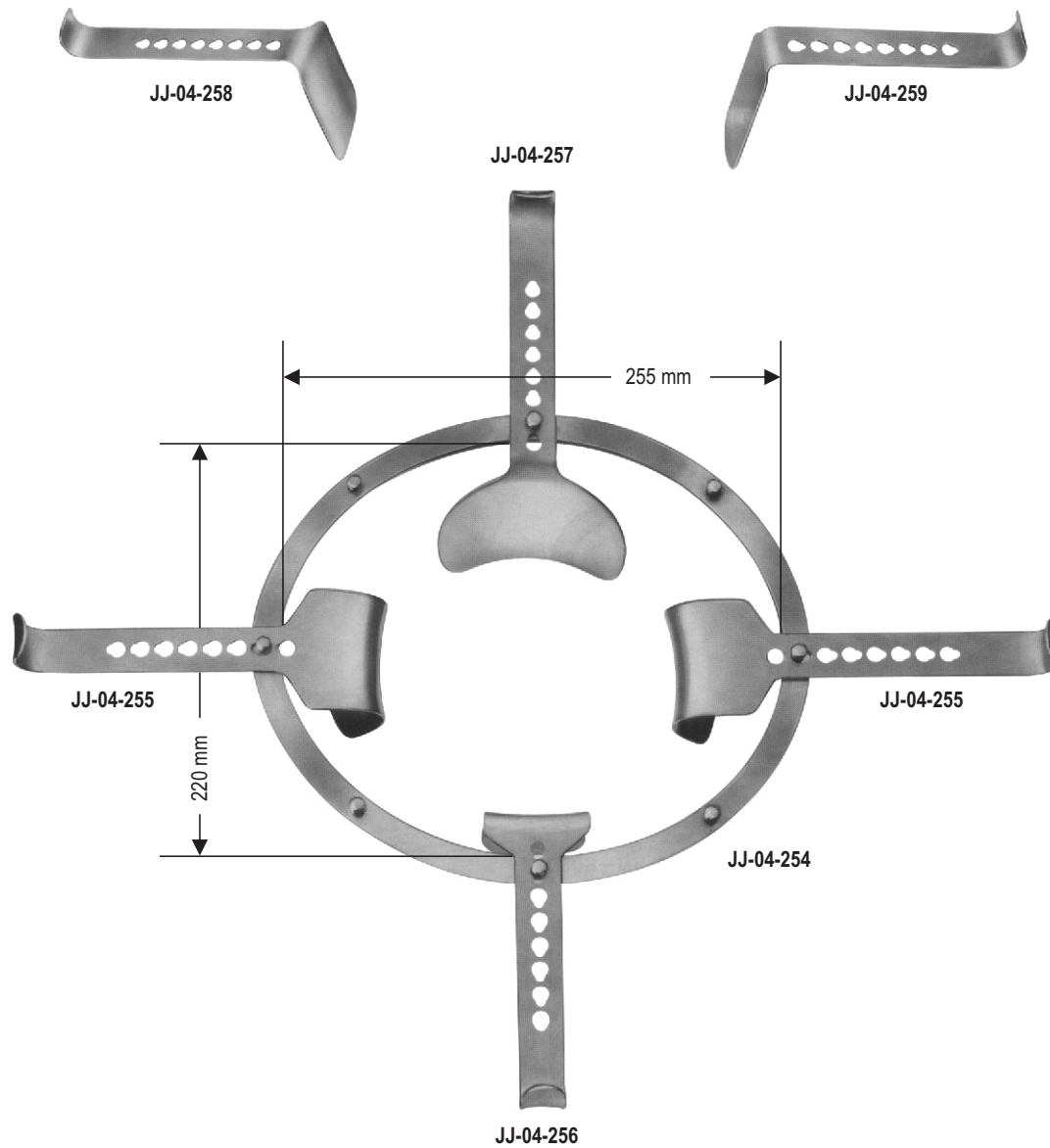

JJ-04-254 - JJ-04-259

SEMM

consisting of:

JJ-04-254 1 frame 225 x 220 mm

JJ-04-255 2 blades 46 x 64 mm

JJ-04-256 1 blade 53 x 54 mm
(for bladder)

JJ-04-257 1 blade 82 x 97 mm
(for intestine)

JJ-04-258 1 blade 98 x 51 mm
(for intestine)

JJ-04-259 1 blade, narrow
107 x 36 mm

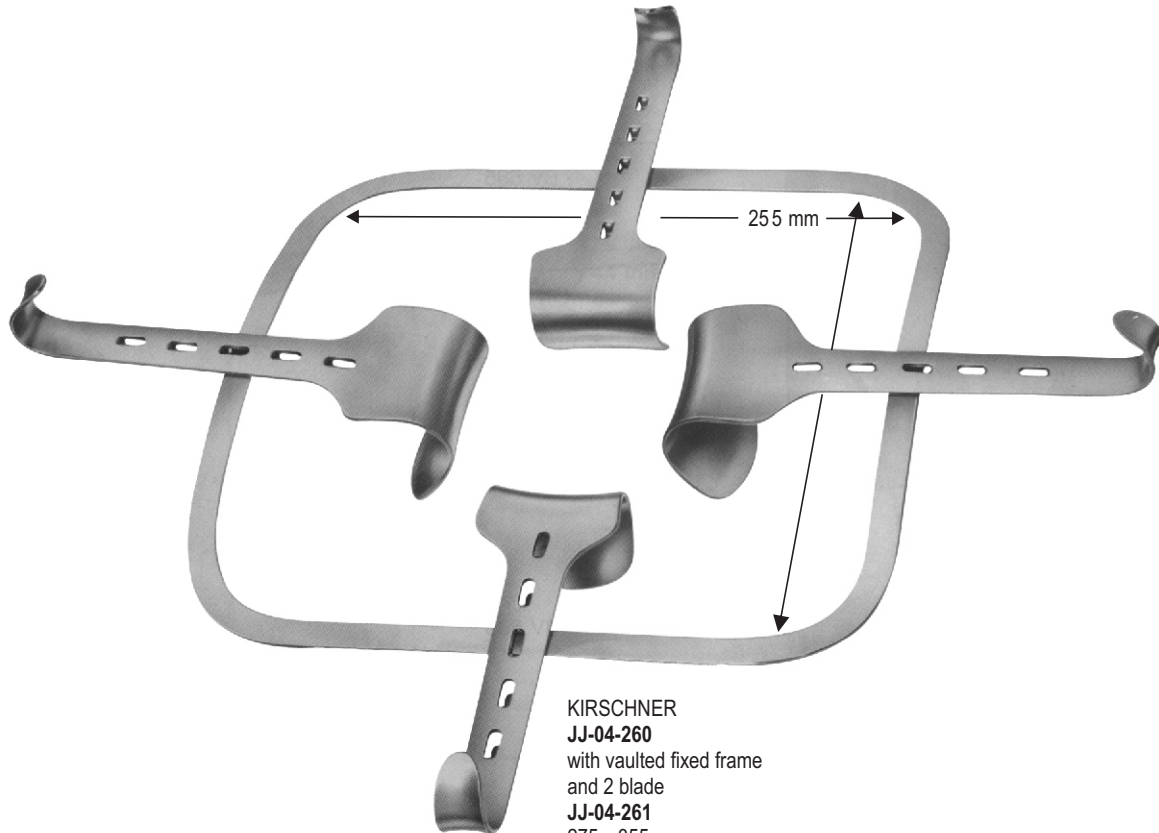

KIRSCHNER
JJ-04-260
with vaulted fixed frame
and 2 blade
JJ-04-261
275 x 355 mm
Frame only, over-sized
JJ-04-262
295 x 275 mm
Frame only



JJ-04-263
KIRSCHNER
64 x 80 mm



JJ-04-264
KIRSCHNER-BALFOUR
80x 82 mm



JJ-04-265 - JJ-04-267
KIRSCHNER
JJ-04-265 90x 69mm
JJ-04-266 92x 95mm
JJ-04-267 78x 58mm



JJ-04-268 - JJ-04-270
KIRSCHNER
JJ-04-268 108x42mm
JJ-04-269 91x 55mm
JJ-04-270 121x 55mm

Page 103-111

- Sponge and Dressing Forceps
- Washing Forceps
- Organ and Tissue Grasping Forceps
- Towel Clamps

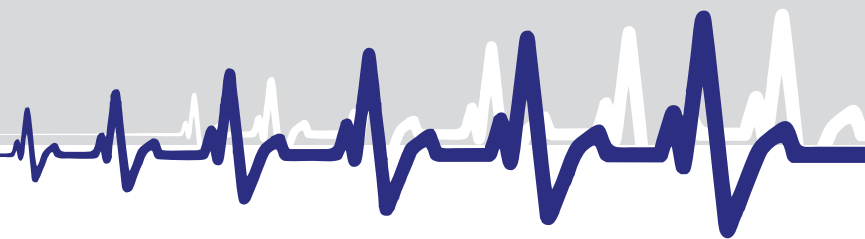

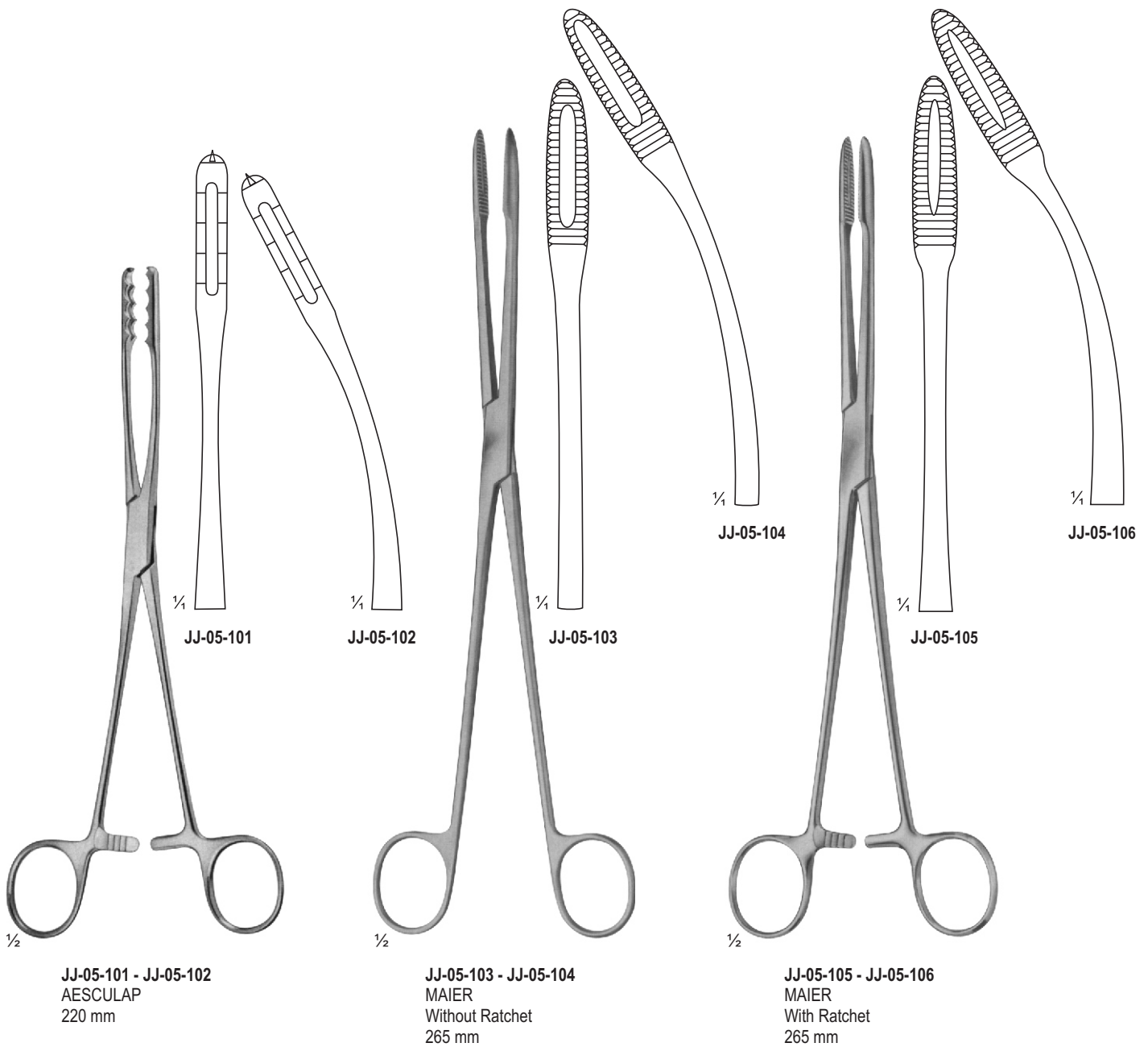

SPONGE AND DRESSING FORCEPS

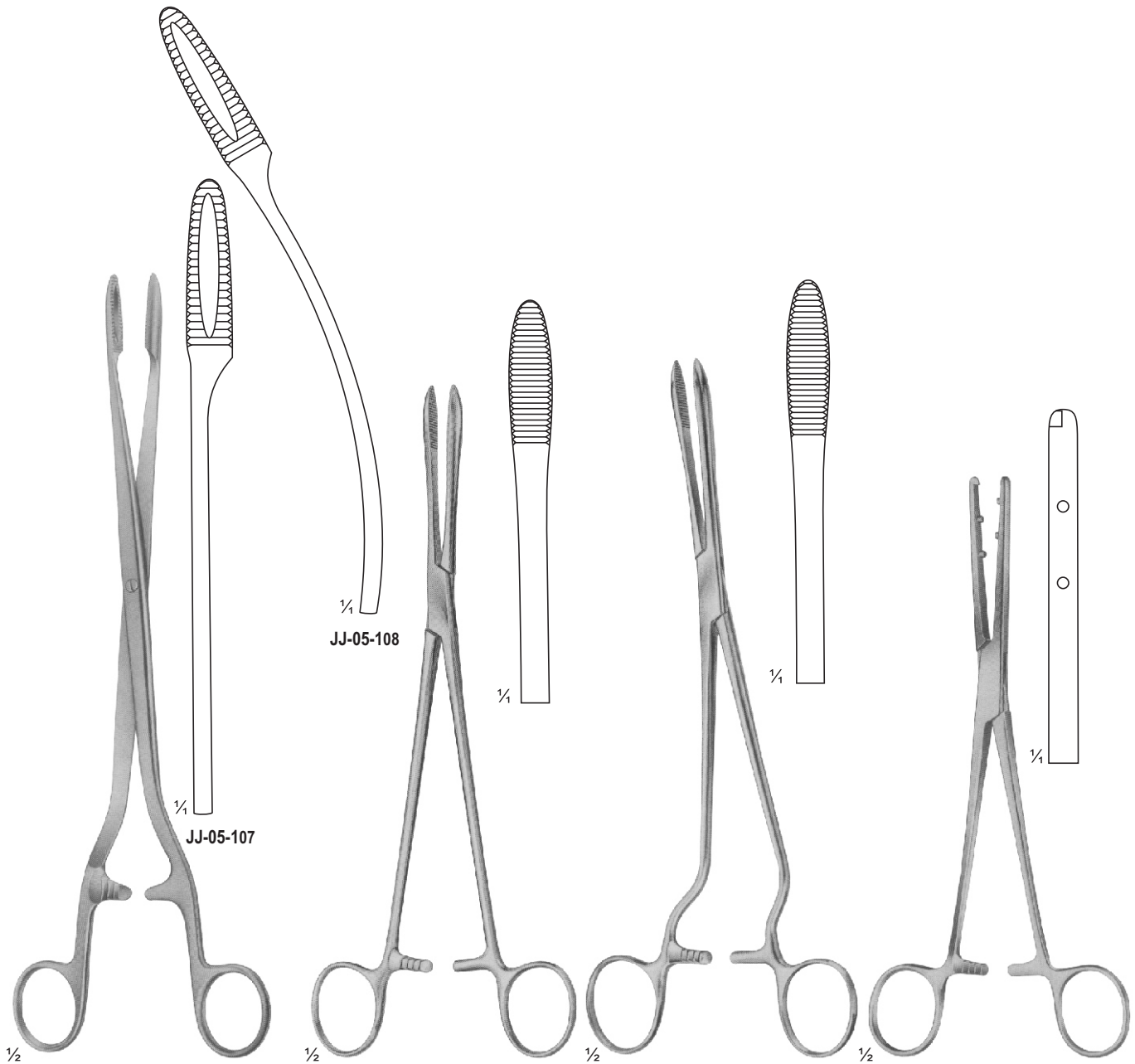

JJ-05-107 - JJ-05-108
SIMS-MAIER
280 mm

JJ-05-109
COLLIN
240 mm

JJ-05-110
CHERON
Handles Laterally Angled
240 mm

JJ-05-111
EMMET
210 mm

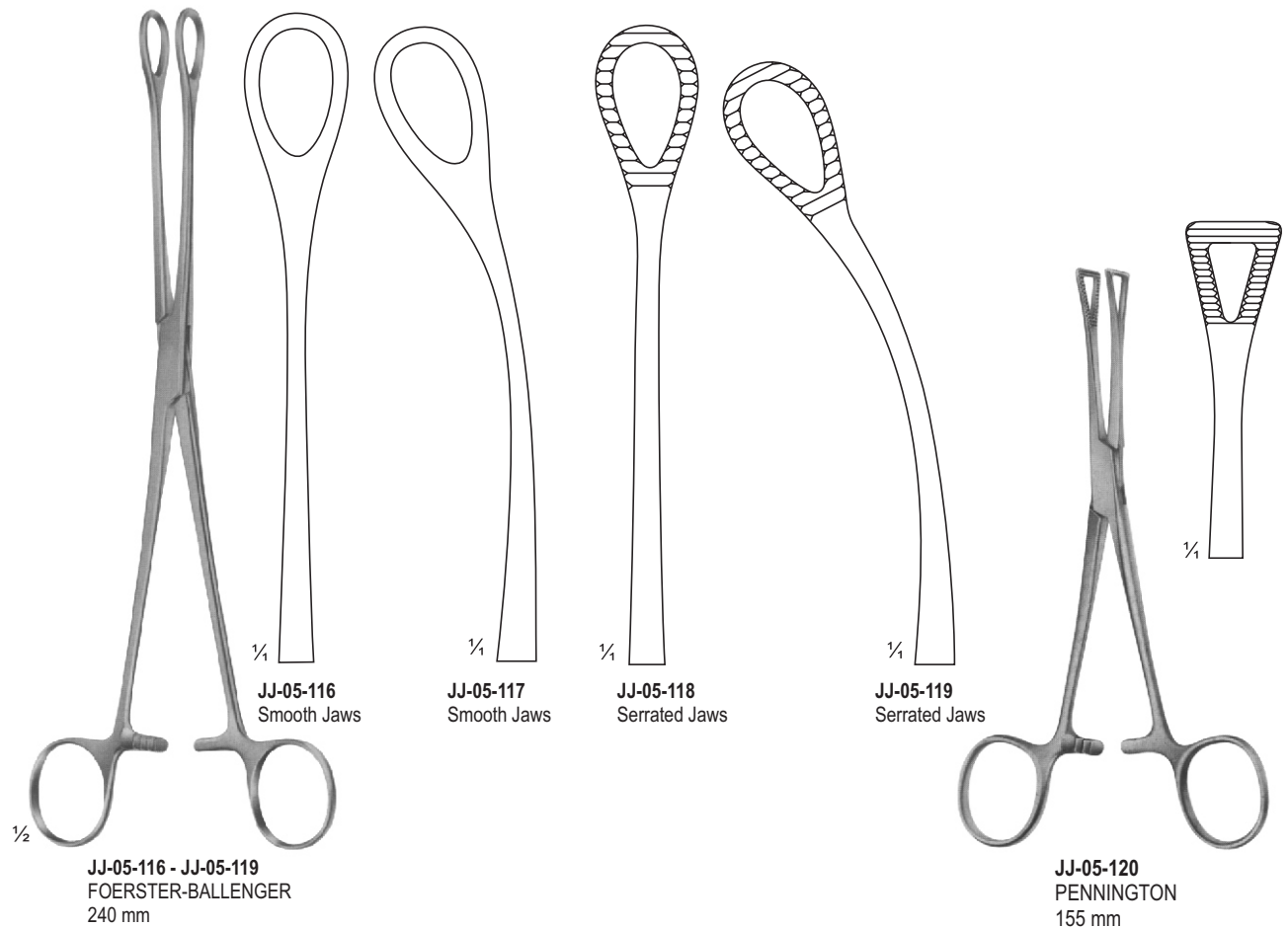
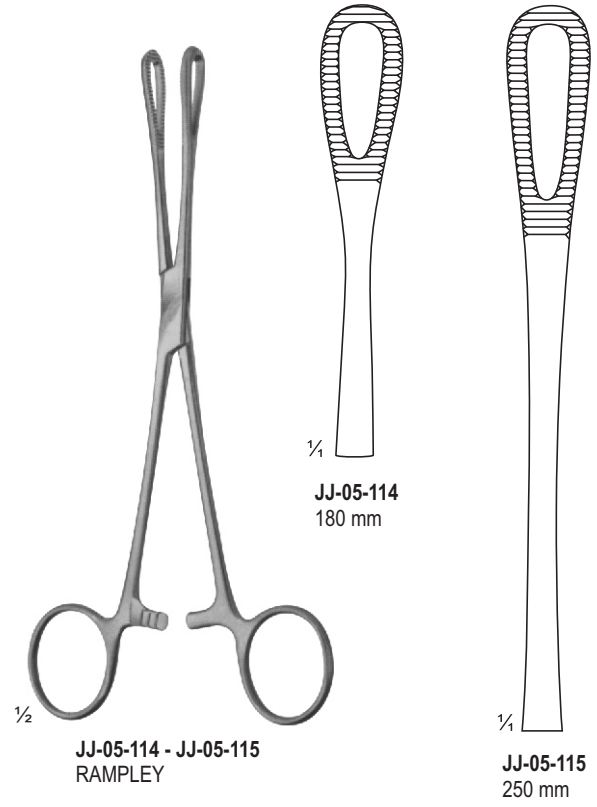
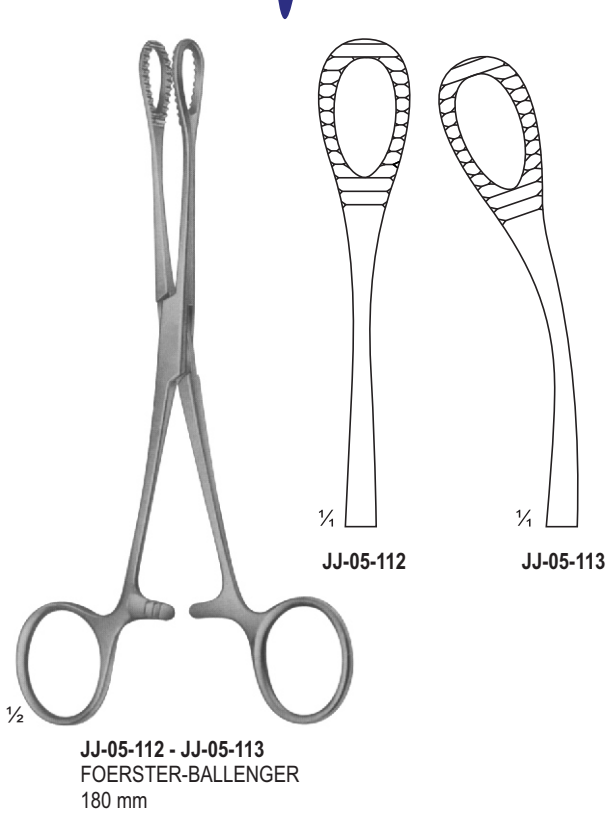

SPONGE AND DRESSING FORCEPS

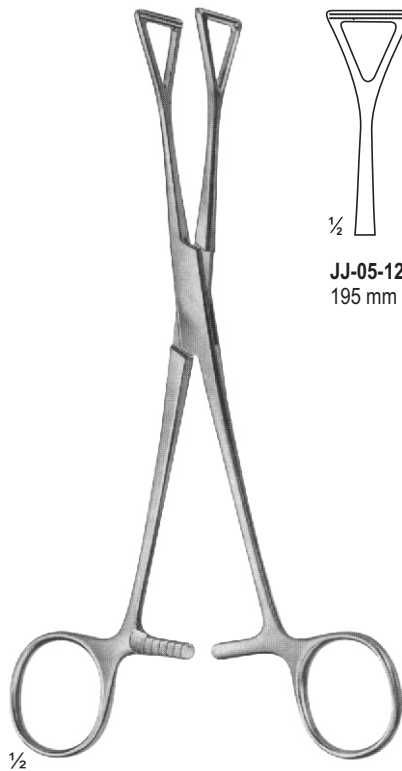

JJ-05-121 - JJ-05-122
COLLIN



JJ-05-121
195 mm

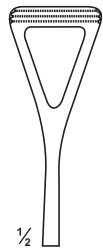

JJ-05-122
230 mm



JJ-05-123 - JJ-05-125
COLLIN

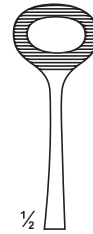

JJ-05-123
160 mm



JJ-05-124
160 mm

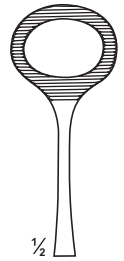

JJ-05-125
170 mm

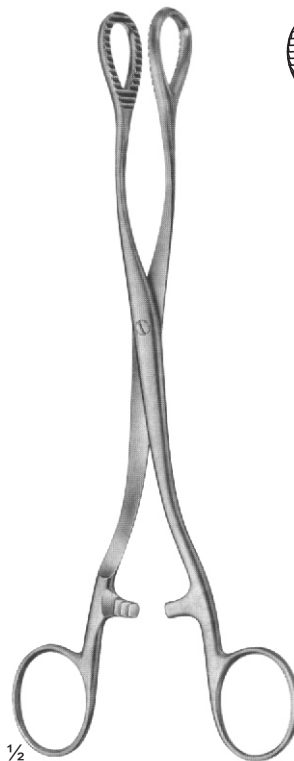

JJ-05-126
HEYWOOD-SMITH
200 mm

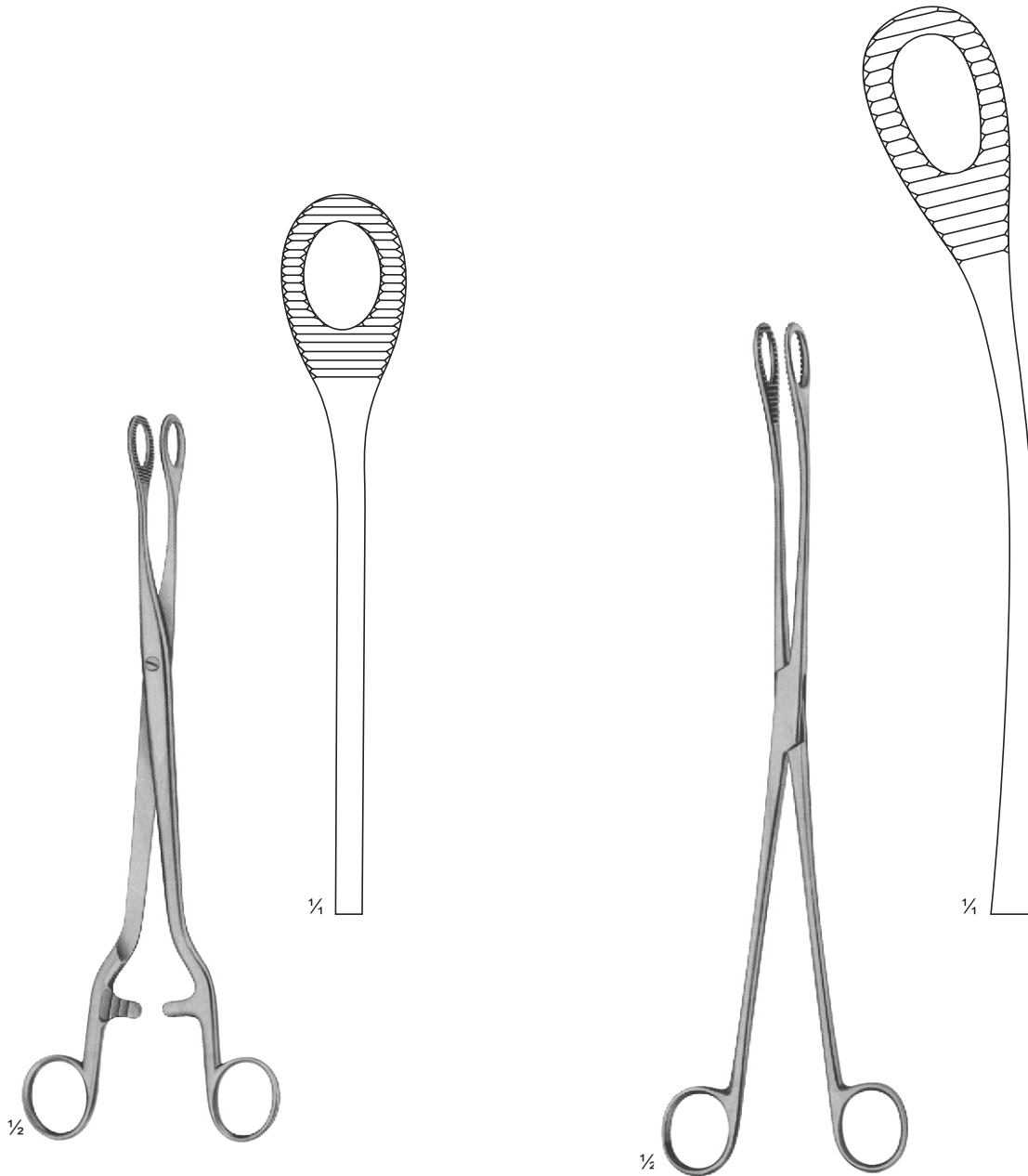

JJ-05-127
NOTO
280 mm

JJ-05-128
KELLY
320 mm

ORGAN AND TISSUE GRASPING FORCEPS

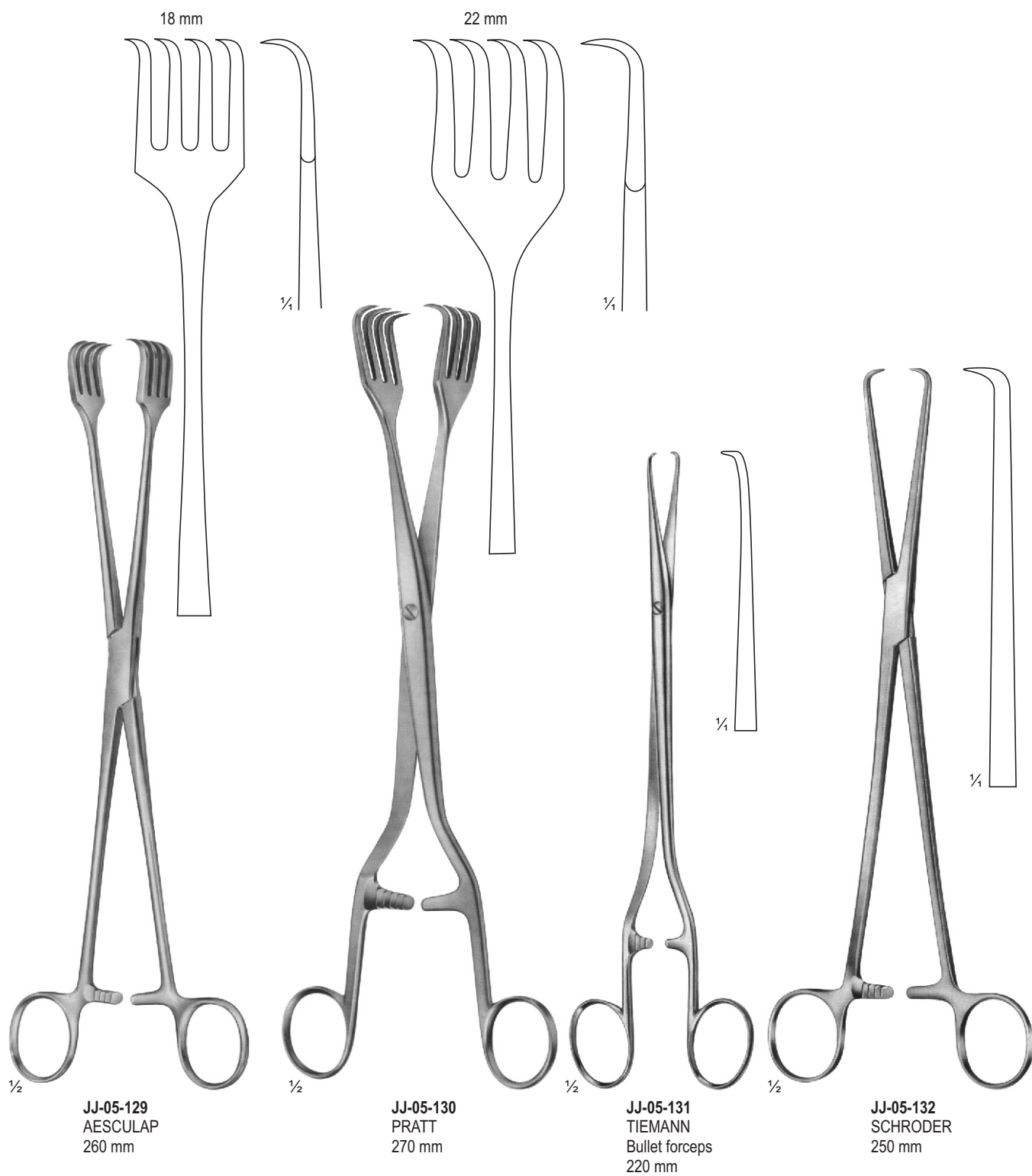

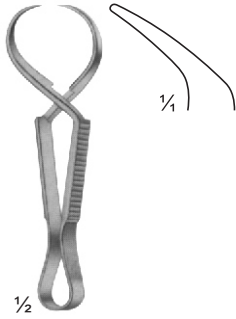

JJ-05-133
JONES
85 mm

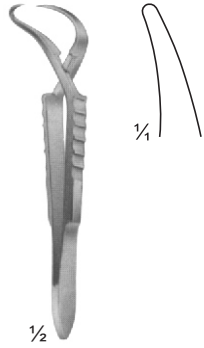

JJ-05-134
ENGL. MOD.
85 mm

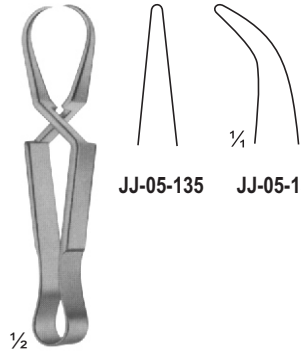

JJ-05-135 **JJ-05-136**

JJ-05-135 - JJ-05-137
SCHAEDEL
85 mm

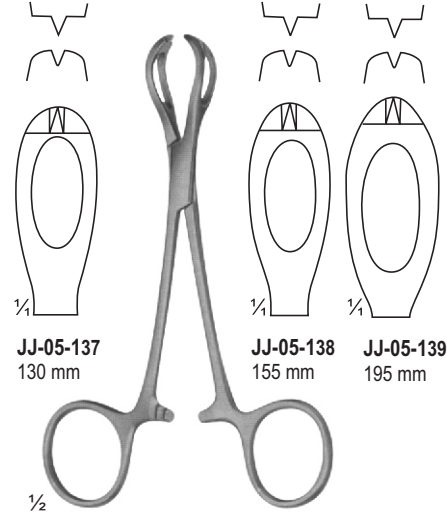

JJ-05-137 **JJ-05-138** **JJ-05-139**
130 mm 155 mm 195 mm

JJ-05-138 - JJ-05-139
LANE

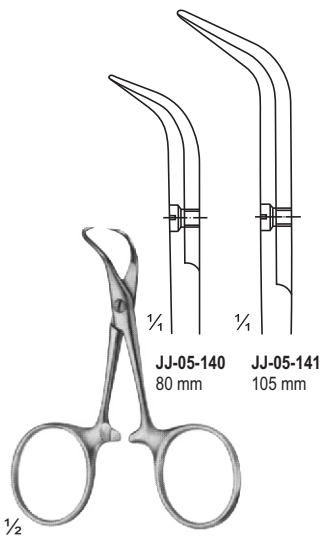

JJ-05-140- JJ-05-141
BACKHAUS

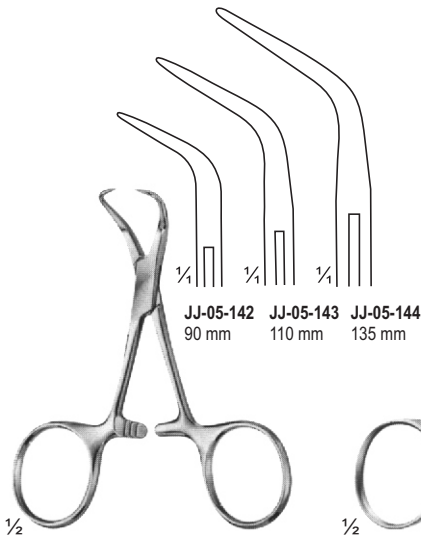

JJ-05-142 - JJ-05-144
BACKHAUS

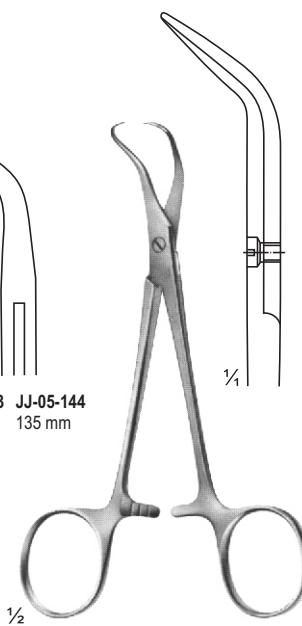

JJ-05-145
BACKHAUS-KOCHER
135 mm

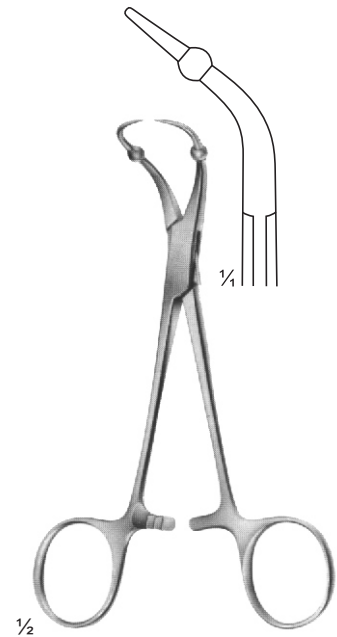

JJ-05-146
ROEDER
135 mm

TENDON SEIZING FORCEPS

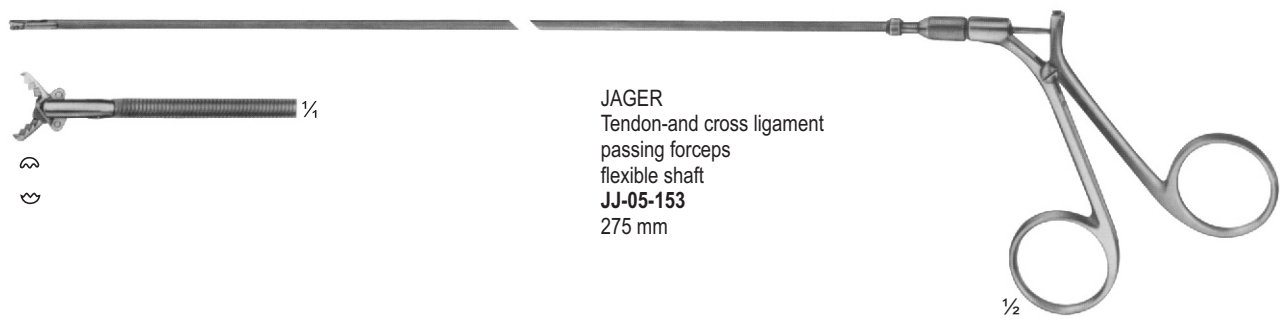
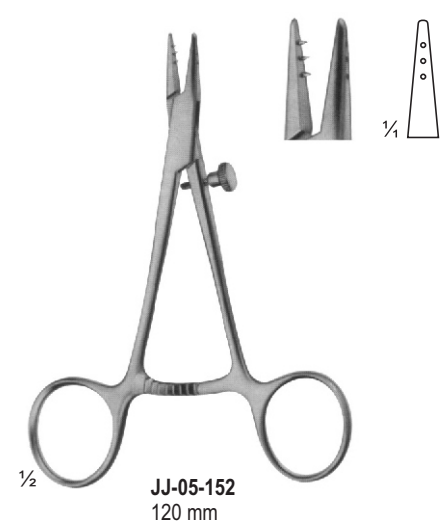
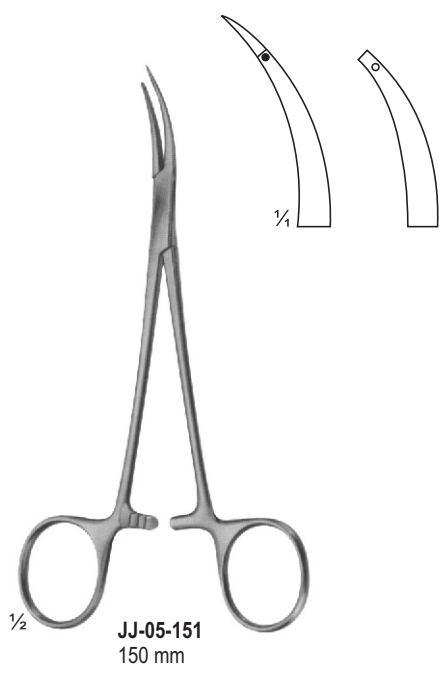
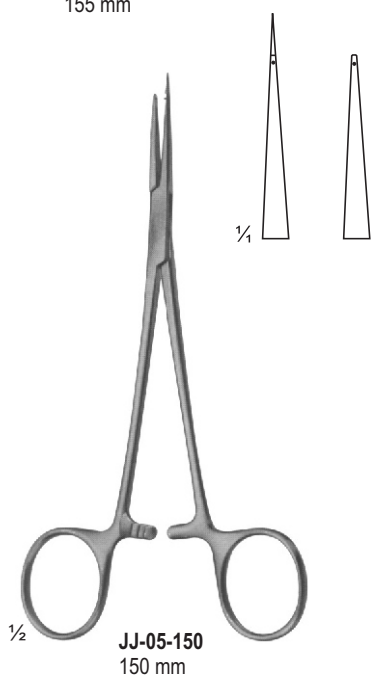
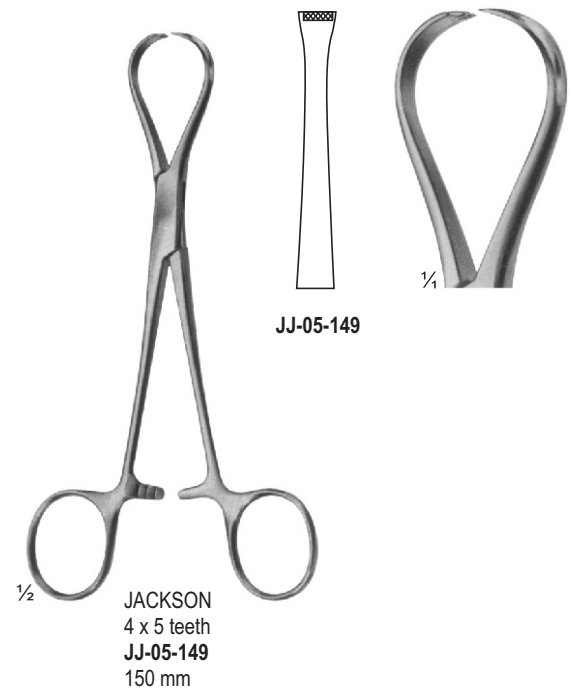
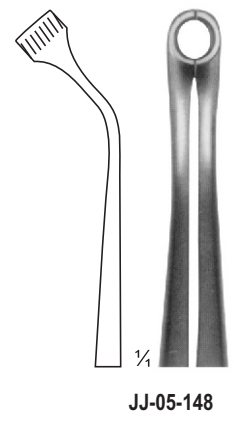
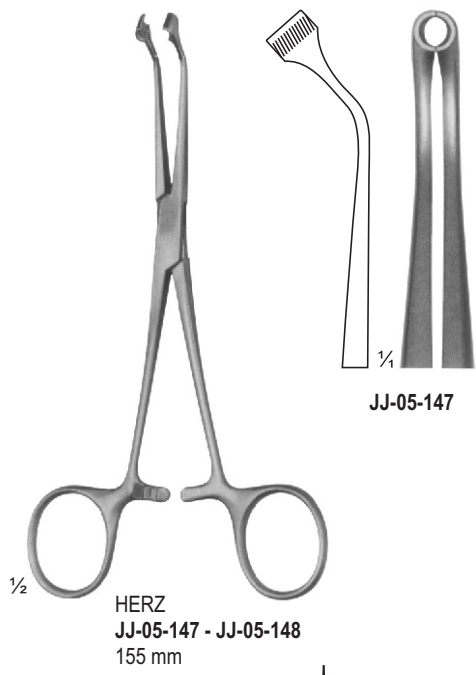

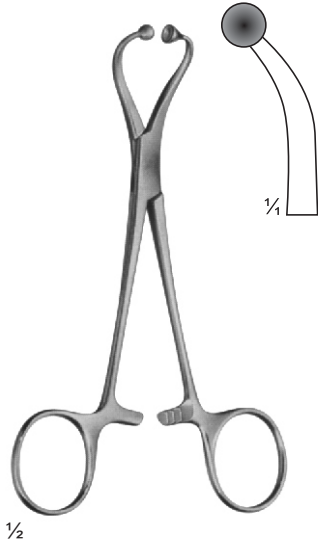

JJ-05-154
for paper cloths
140 mm

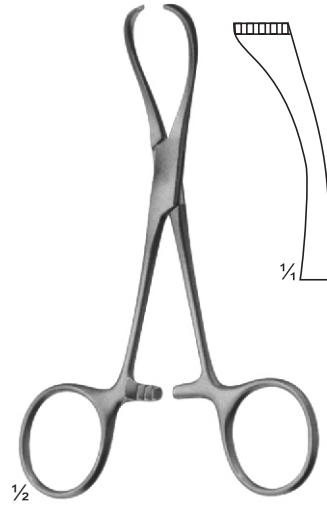

JJ-05-155
LORNA
non perforating
130 mm

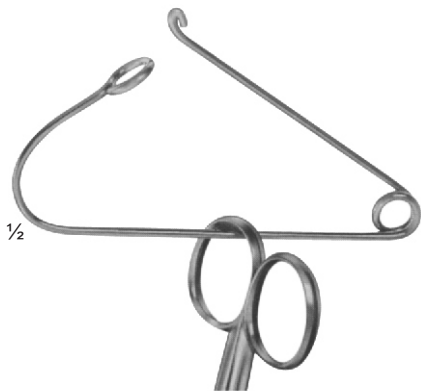

JJ-05-156
BUNT
105 mm



JJ-05-157
MAYO
140 mm

Page 112-130

- Bone Punches
- Rongeurs
- Amputation

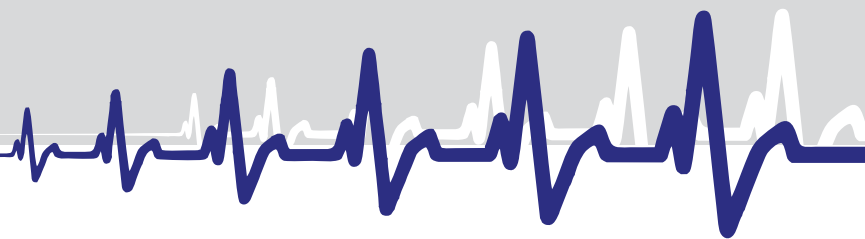

90° upwards cutting

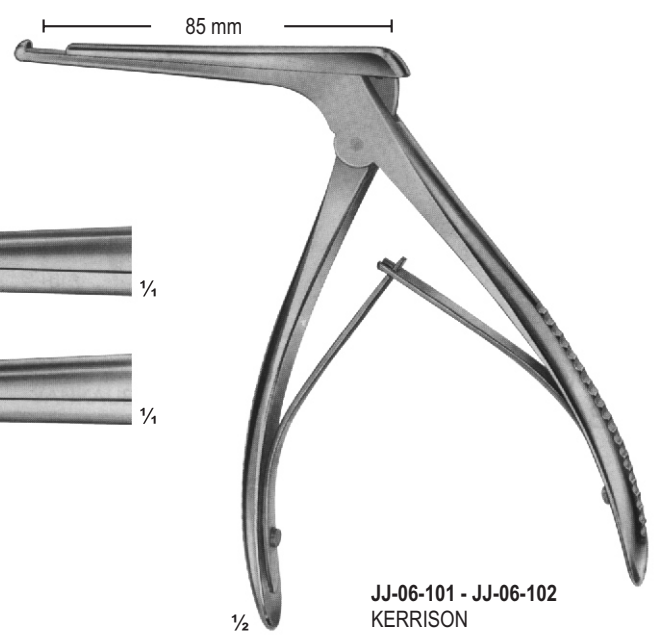

JJ-06-101
4 mm



JJ-06-102
5 mm



JJ-06-101 - JJ-06-102
KERRISON

90° upwards cutting

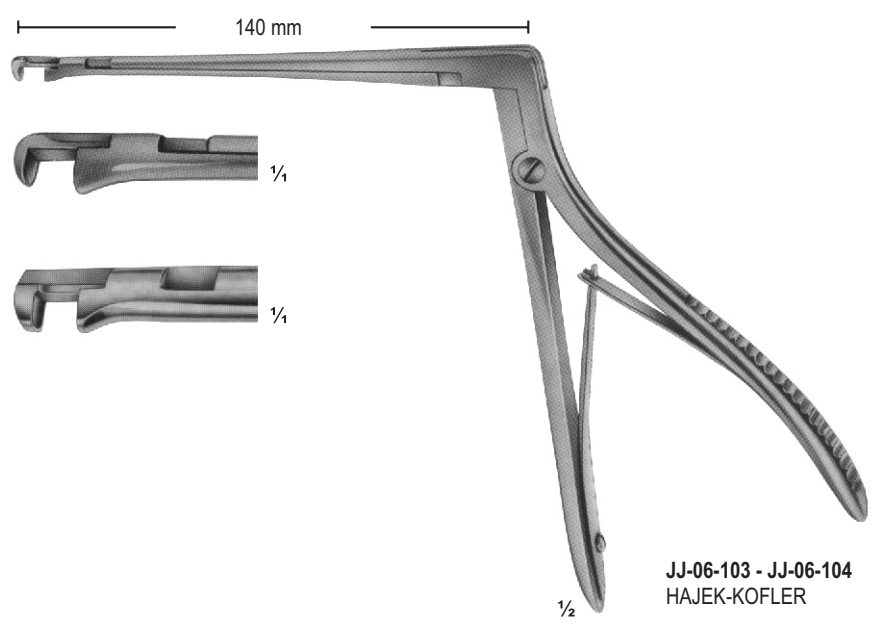

JJ-06-103
3,3 mm



JJ-06-104
4,0 mm

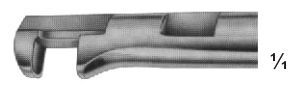

JJ-06-103 - JJ-06-104
HAJEK-KOFLER

130°

upwards cutting

140 mm

JJ-06-105
1 mm



JJ-06-106
2 mm



JJ-06-107
3 mm

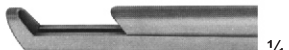

JJ-06-108
4 mm



JJ-06-109
5 mm



JJ-06-105 - JJ-06-109
KERRISON-JACOBY

90°

upwards cutting

180 mm

JJ-06-110
1 mm



JJ-06-111
2 mm



FERRIS-SMITH-KERRISON

JJ-06-112
3 mm

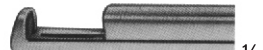

JJ-06-113
4 mm

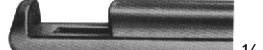

JJ-06-114
5 mm

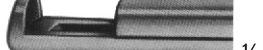

JJ-06-110 - JJ-06-114
KERRISON-JACOBY

Angled positions for rongeurs

- JJ-06-115**
3,0 mm
- JJ-06-116**
3,6 mm
- JJ-06-117**
4,2 mm
- JJ-06-118**
4,8 mm
- JJ-06-119**
5,8 mm

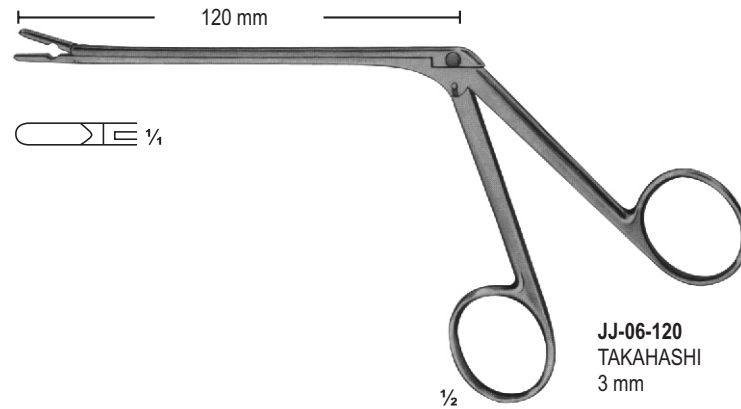
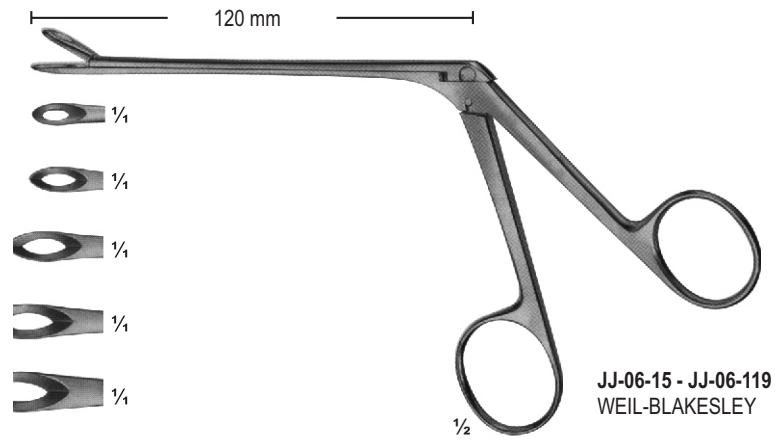

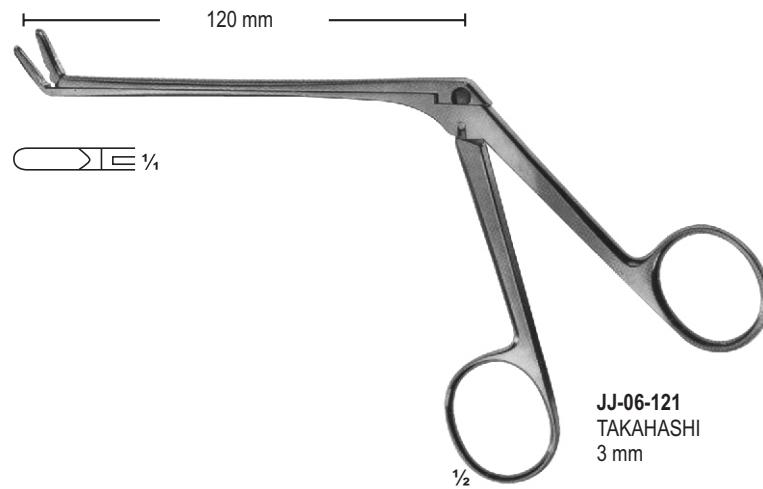

130°

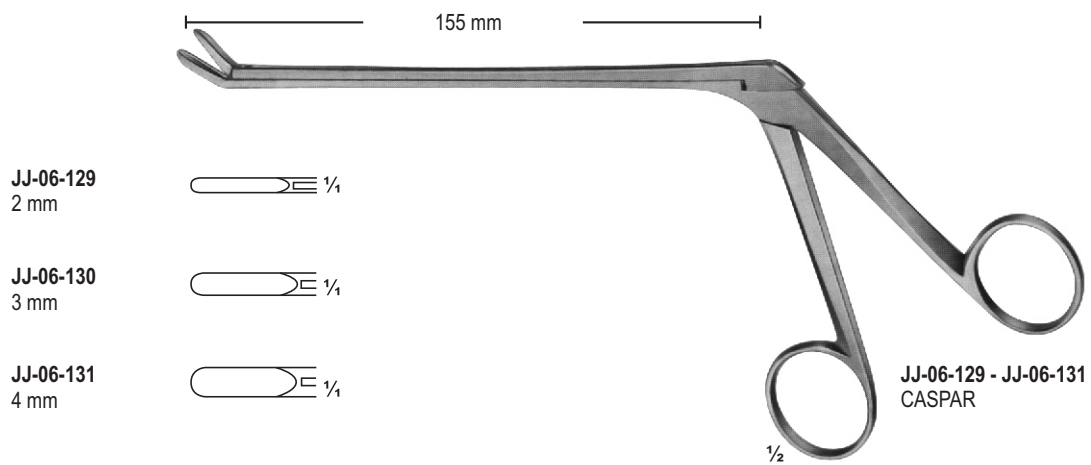
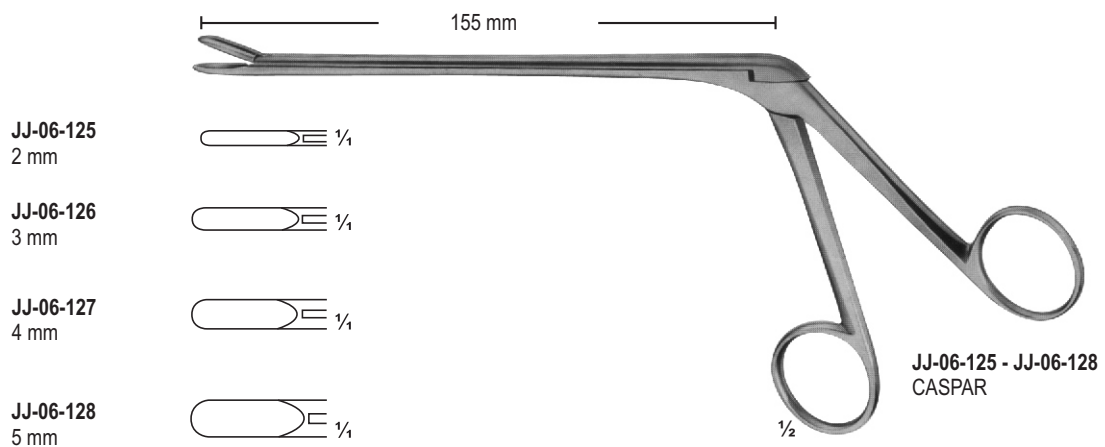
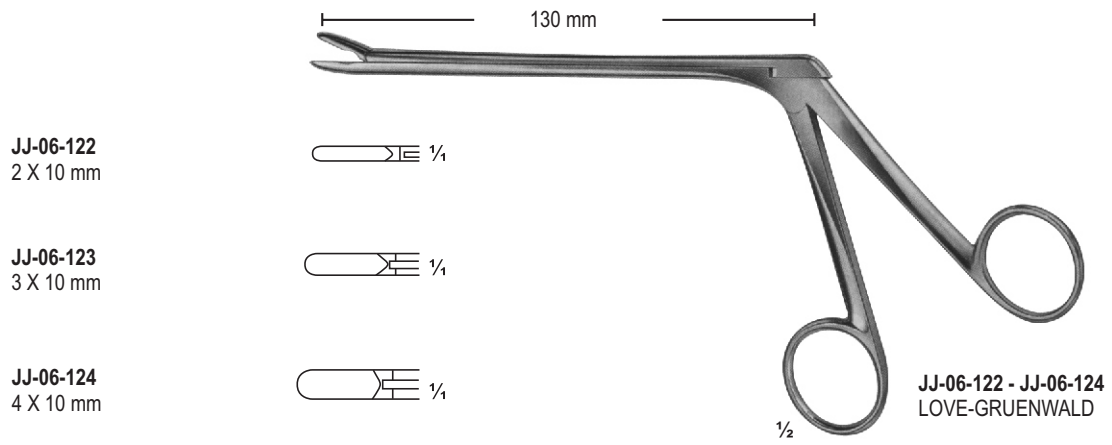

RONGEURS



Length of shaft 140 mm	Length of shaft 160 mm	Length of shaft 185 mm	size of jaws
JJ-06-132	JJ-06-134	JJ-06-136	3 X12 mm  1/4
JJ-06-133	JJ-06-135	JJ-06-137	4 X14 mm  1/4

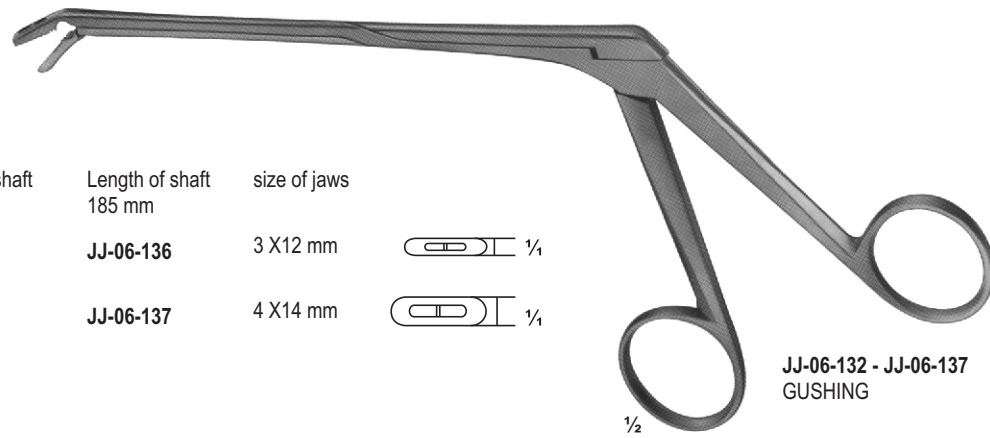

JJ-06-138
2 X 10 mm
GUSHING



JJ-06-139
3 X 10 mm
LOVE-GRUENWALD

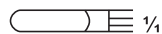

JJ-06-140
4 X 10 mm
SPURLING

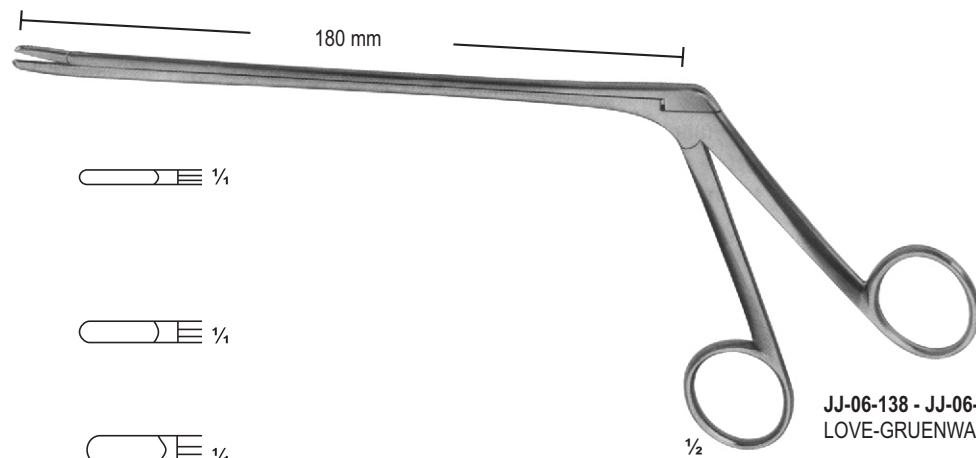

JJ-06-141
3 X 10 mm
LOVE-GRUENWALD



JJ-06-142
4 X 10 mm
SPURLING

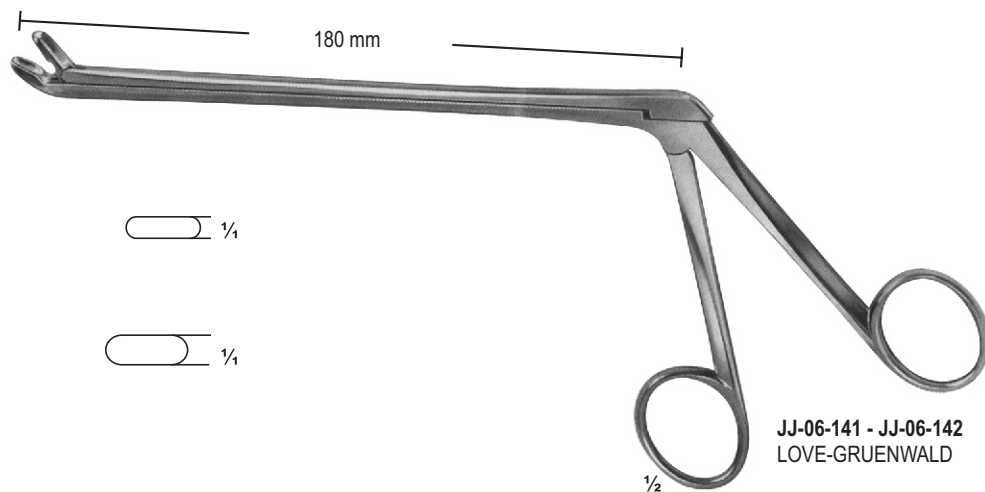

RONGEURS

JJ-06-143
3 X 10 mm
LOVE-GRUENWALD

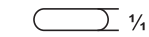

JJ-06-144
4 X 10 mm
SPURLING

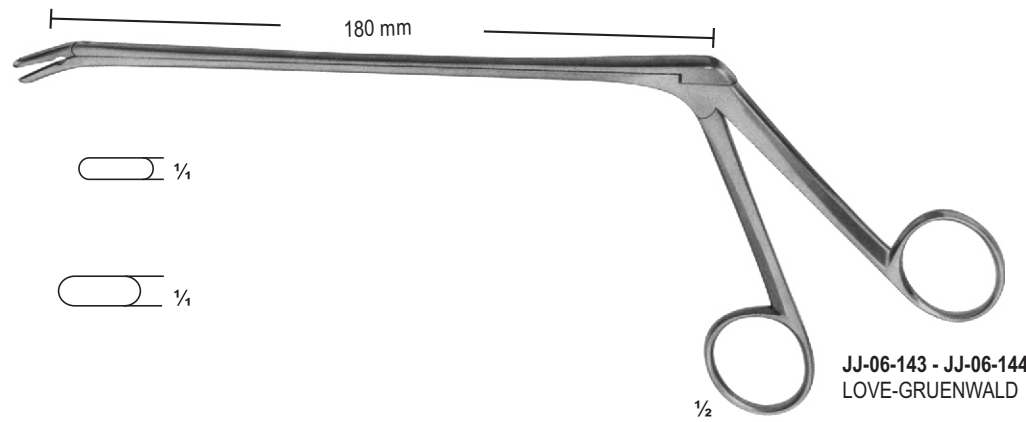

JJ-06-143 - JJ-06-144
LOVE-GRUENWALD

JJ-06-145
7 mm

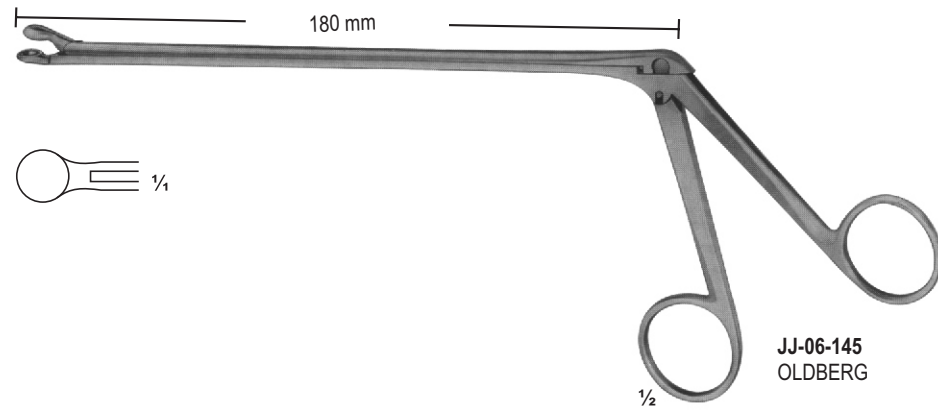
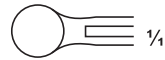

JJ-06-145
OLDBERG

JJ-06-146
YASARGIL
2,2 mm



JJ-06-147
YASARGIL
3,5 mm

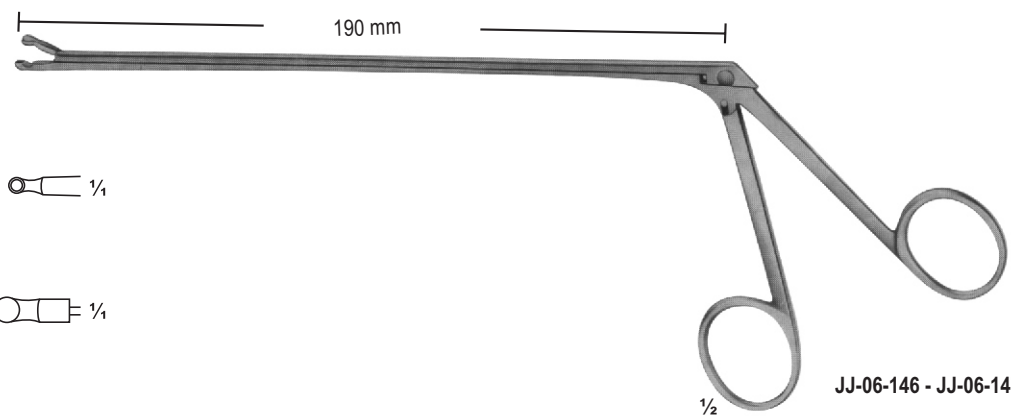

JJ-06-146 - JJ-06-147

145 mm

JJ-06-148
4 mm

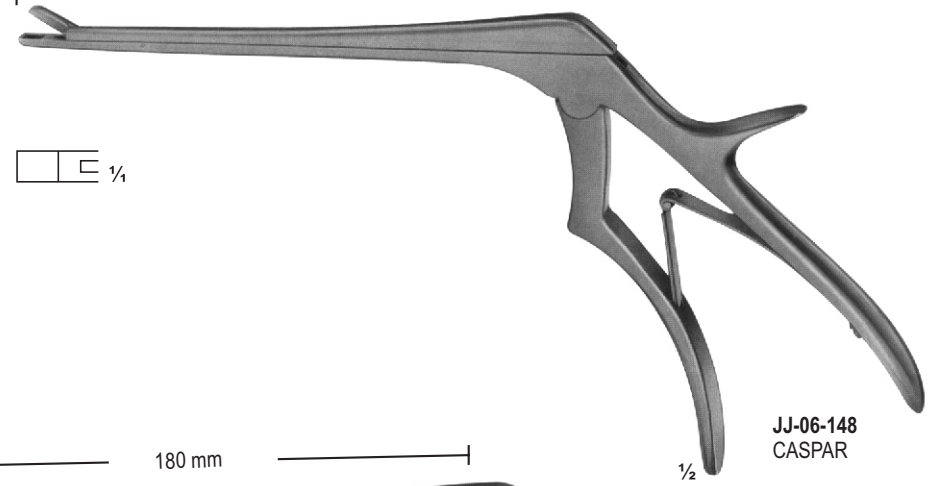

JJ-06-148
CASPAR
1/2

180 mm

JJ-06-149
4 mm

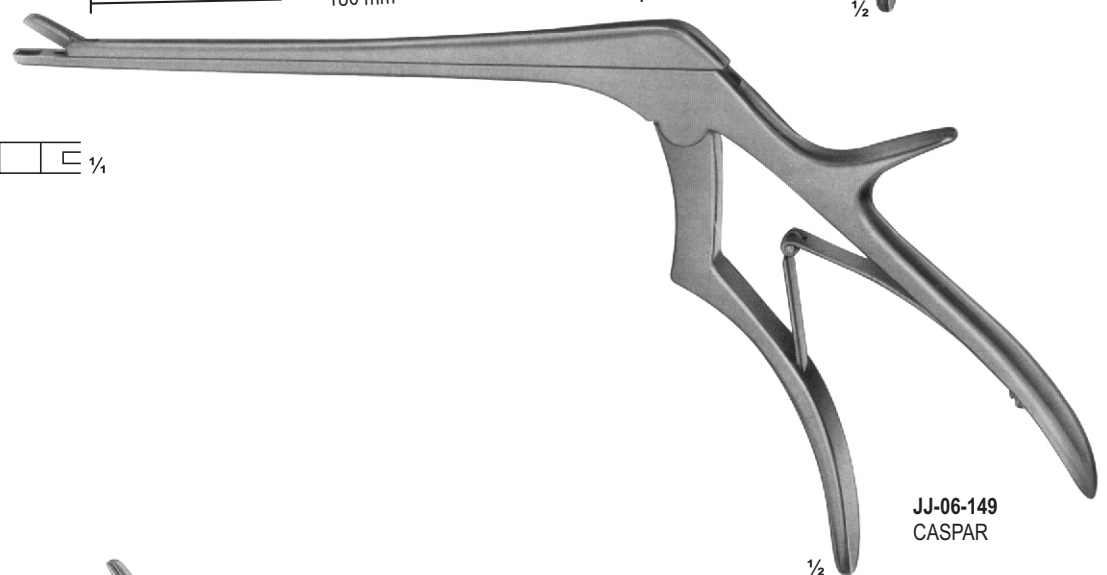

JJ-06-149
CASPAR
1/2

200 mm

JJ-06-150
5,5 mm

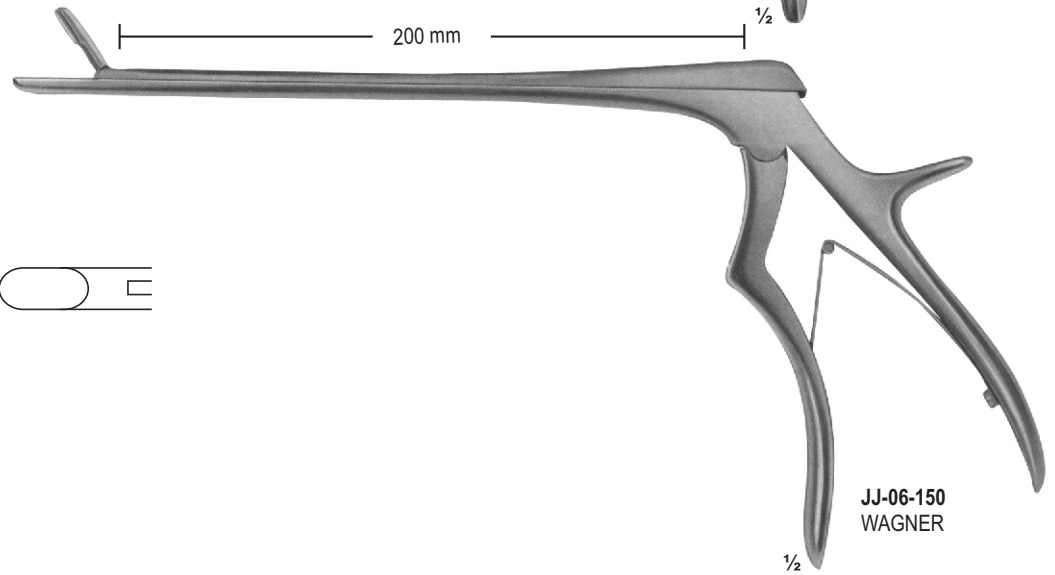

JJ-06-150
WAGNER
1/2

PUNCHES

90° upwards cutting

85 mm

JJ-06-151
4 mm



1/4

JJ-06-152
5 mm



1/4

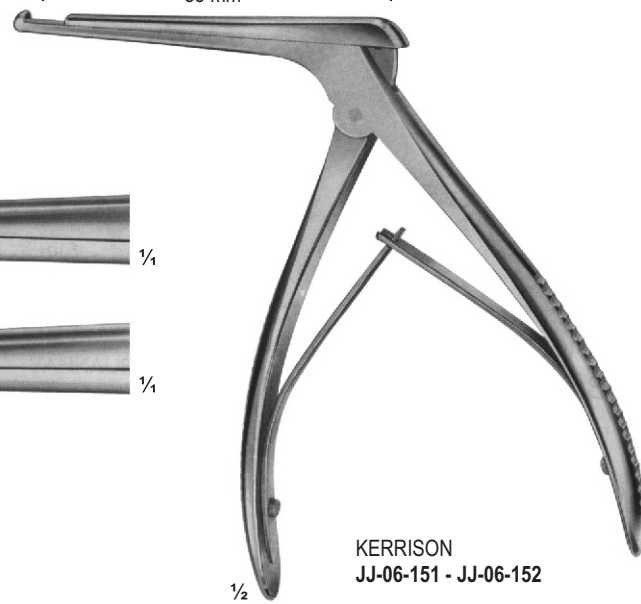

KERRISON
JJ-06-151 - JJ-06-152

1/2

90° upwards cutting

140 mm

JJ-06-153
3.3 mm



1/4

JJ-06-154
4 mm

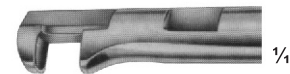

1/4

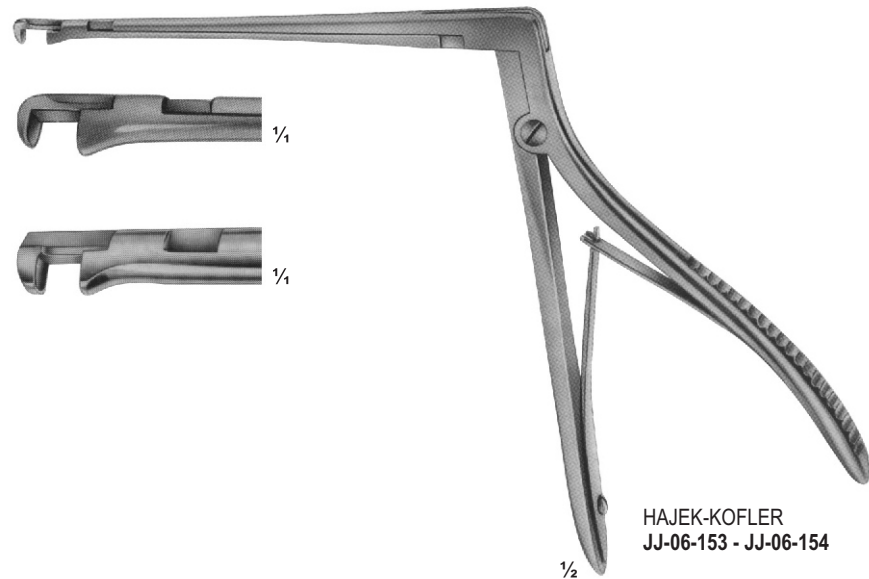

HAJEK-KOFLER
JJ-06-153 - JJ-06-154

1/2

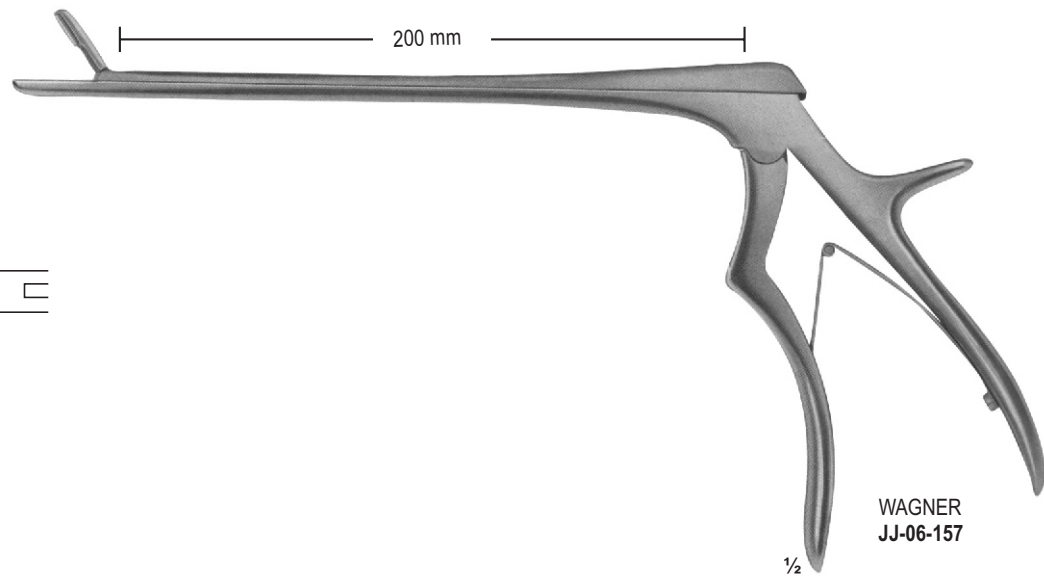
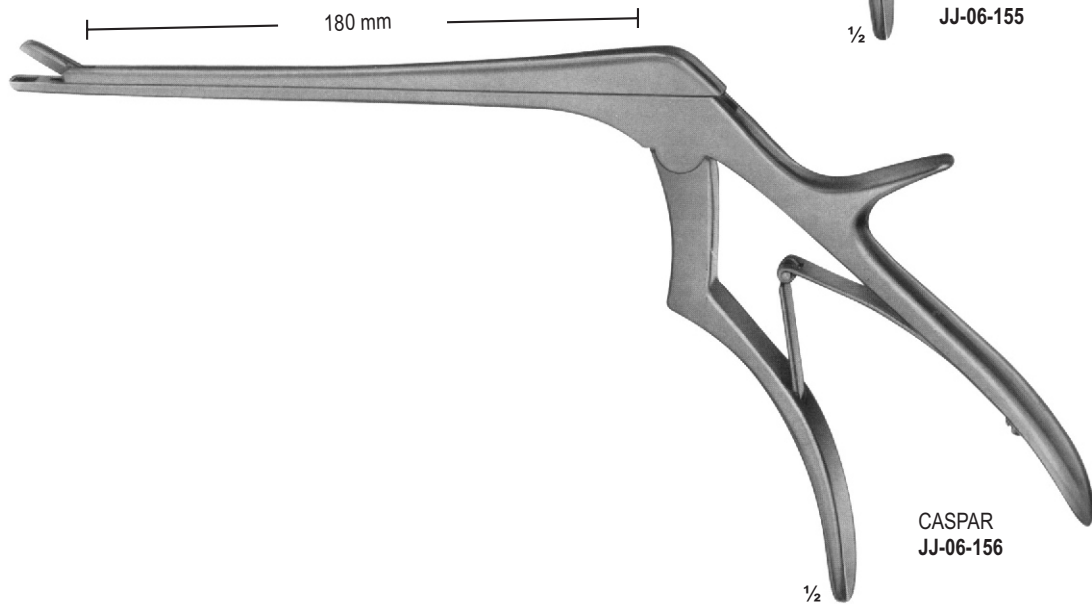
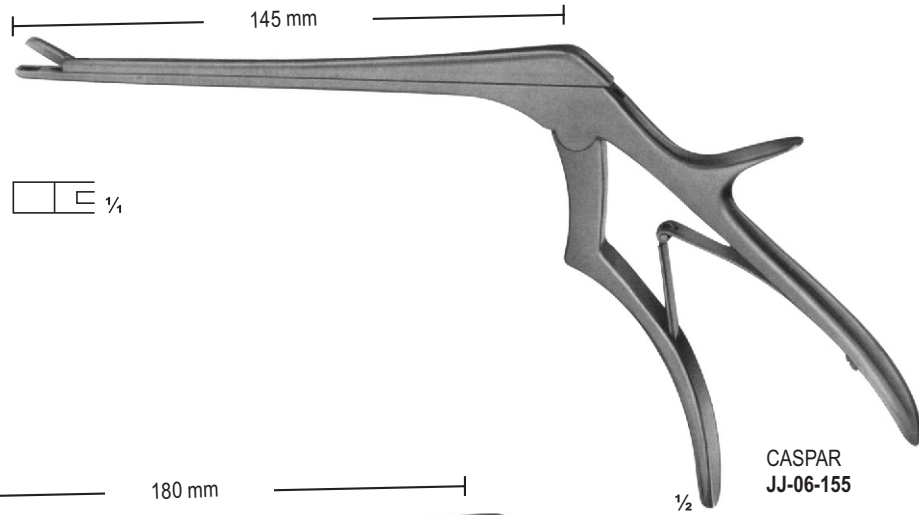

PUNCHES

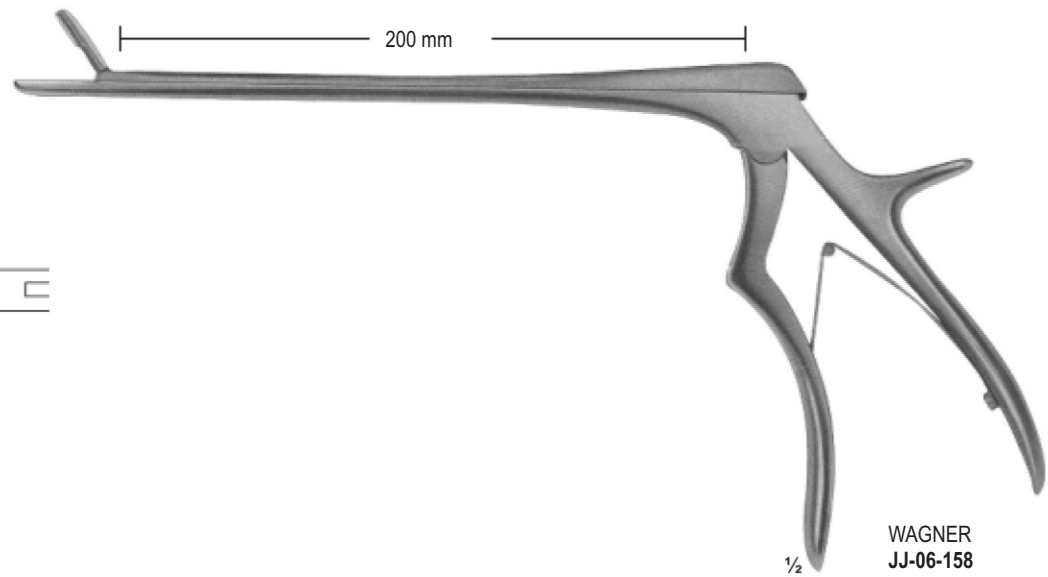

JJ-06-158
5.5 mm



1/2
WAGNER
JJ-06-158



JJ-06-159
CHARRIEER
Length of blade
215 mm
complete with one saw
blade each
350 mm
Spare saw blades, carbon steel
JJ-06-160 12 mm
JJ-06-161 20 mm

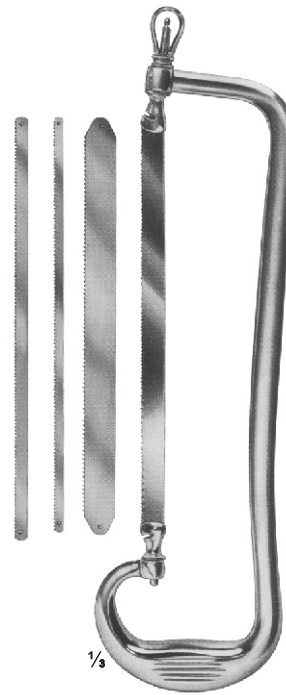

JJ-06-162
RUST
Length of blade
235 mm
complete with one saw
blade each
390 mm
JJ-06-163 Bow only
Spare saw blades, carbon steel
JJ-06-164 6 mm
JJ-06-165 12 mm
JJ-06-166 20 mm

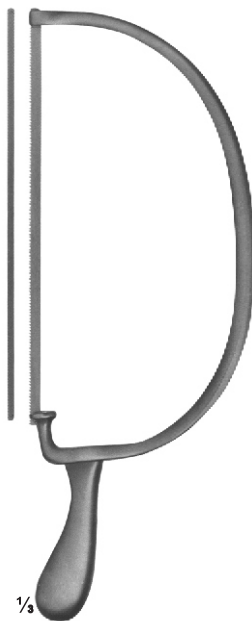

JJ-06-167
BIER
Length of blade
270 mm
complete with one saw
blade each
420 mm
Spare saw blades, carbon steel
JJ-06-168 4 mm
JJ-06-169 6 mm
JJ-06-170 8 mm

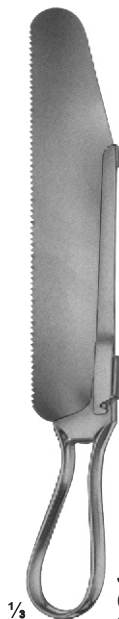

JJ-06-171
CHARRIERE
Length of blade
180 mm
Spare saw blades,
carbon steel
JJ-06-172
CHARRIERE
Length of blade
240 mm
Spare saw blades,
carbon steel
340 mm

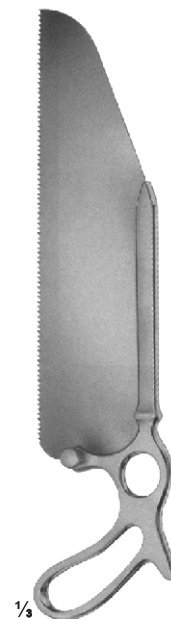

JJ-06-173
SATTERLEE
Length of blade
200 mm
Spare saw blades,
carbon steel
290 mm



JJ-06-174
LANGENBECK
Length of blade
115 mm
Metacarpal saw
235 mm

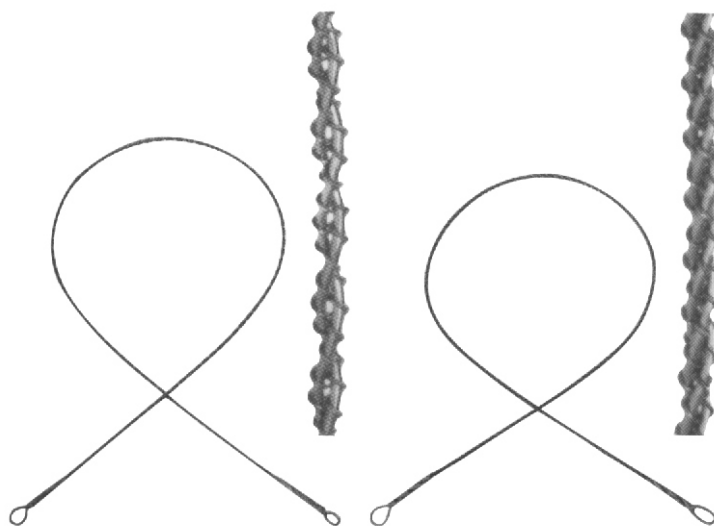

OLIVECRONA
JJ-06-175 300 mm
JJ-06-176 400 mm
JJ-06-177 500 mm
JJ-06-178 700 mm

GIGLI
JJ-06-179 300 mm
JJ-06-180 400 mm
JJ-06-181 500 mm
 fine, 6 wires twisted
JJ-06-182
 coares, 4 wires twisted



1/4

JJ-06-183
 GIGLI
 Handle



1/2

JJ-06-184
 LEBSCHKE
 Conductor for
 wire saws, malleable
 250 mm

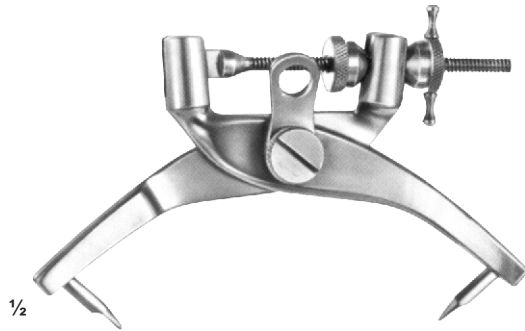

1/2

CRUTCHFIELD
JJ-06-185
Small Pattern



1/2

CRUTCHFIELD
JJ-06-186
Medium Pattern



1/2

JJ-06-187
Large Pattern
and Spare Pin



JJ-06-188
70 mm
Drill Point



JJ-06-189
70 mm
Drill Point

CRANIAL RONGEURS



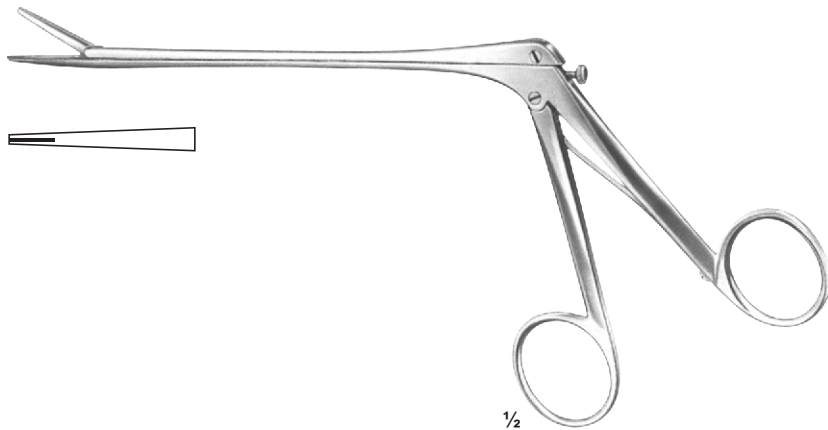

1/2

OLIVECRONA-TOENNIS
JJ-06-193
Clip Applying Forceps

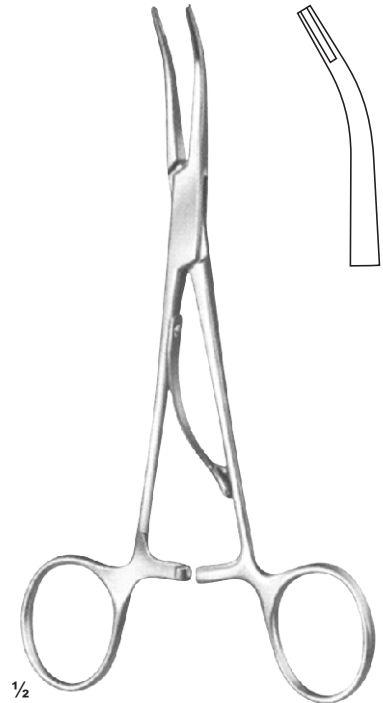

1/2

MCKENZIE
JJ-06-194
185 mm
Clip Applying Forceps



1/4

KÖLNER
JJ-06-195
Scalp Clip



1/4

RANEY
JJ-06-196
Scalp Clip



1/2

RANEY
JJ-06-197
155 mm
Applying/Removal
Forceps

BONE HAND DRILLS

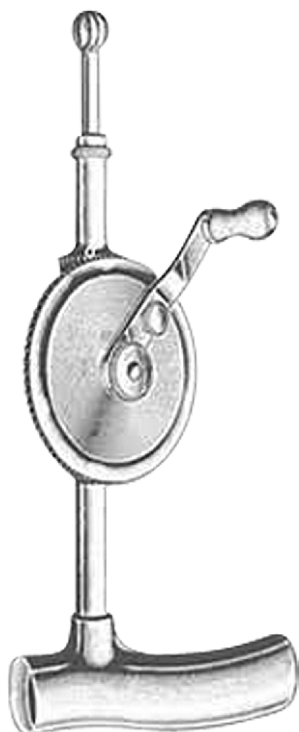

STILLE
JJ-06-198 - JJ-06-209
 complete
 20 cm



JJ-06-198
 2.5 mm



JJ-06-199
 3.0 mm



JJ-06-200
 3.5 mm



JJ-06-201
 4.0 mm



JJ-06-202
 10.0 mm



JJ-06-203
 5.0 mm



JJ-06-204
 8.0 mm



JJ-06-205
 12.0 mm



JJ-06-206
 16.0 mm



JJ-06-207
 1.0 mm



JJ-06-208
 1.5 mm



JJ-06-209
 2.0 mm

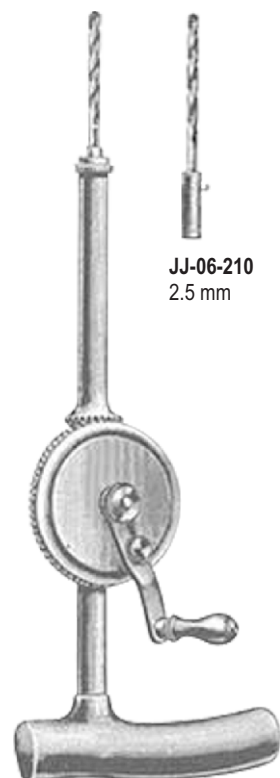

STILLE-SHERMAN
JJ-06-210 - JJ-06-212
 complete
 24 cm



JJ-06-210
 2.5 mm



JJ-06-211
 3.0 mm



JJ-06-212
 3.5 mm



MOORE
JJ-06-213
 complete
 28 cm



Set of 3

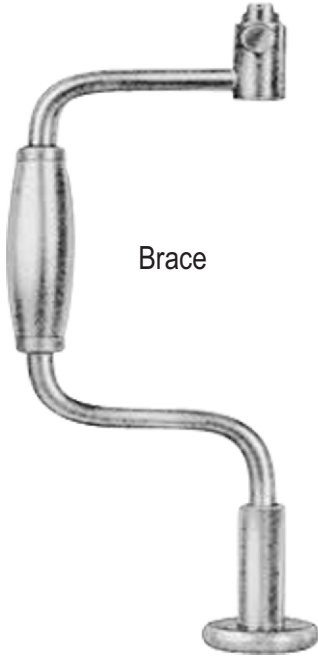

Brace

HUDSON
JJ-06-214 - JJ-06-223
Complete Set
27 cm



JJ-06-214
9 mm



JJ-06-215
14 mm



JJ-06-216
16 mm



JJ-06-217
22 mm



JJ-06-218
14 mm



JJ-06-219
Extension
Piece



JJ-06-220
Mckenzie
15 mm



JJ-06-221
Mckenzie
2.0 mm



JJ-06-222
Mckenzie
1.3 mm



JJ-06-223
Derrico
1.6 mm



KIRSCHNER
JJ-06-224
Complete



Telescope Wire
Dill Guide



JJ-06-225
Complete



Telescope Wire
Dill Guide

BONE HAND DRILLS

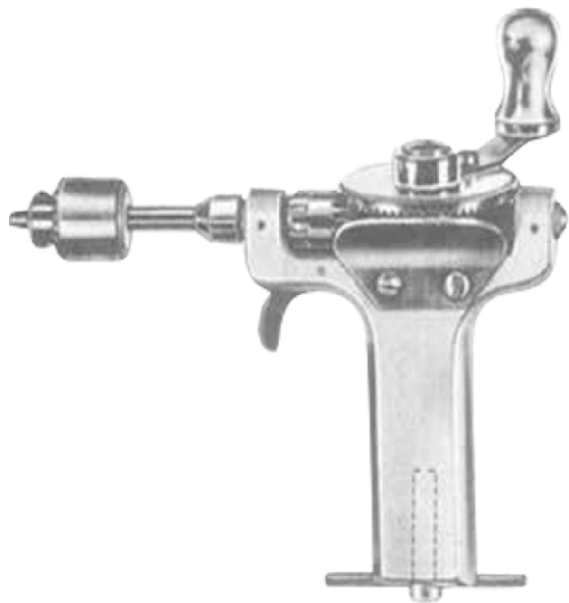

BUNNELL
JJ-06-226



ROLK
JJ-06-227



JJ-06-228
Drilling chuck, cannulated,
for shanks up to 6.35 mm diam.,
To be tightened by hand
10 cm



JJ-06-229
Drilling chuck, cannulated,
for shanks up to 6.35 mm diam.,
With key
16 cm

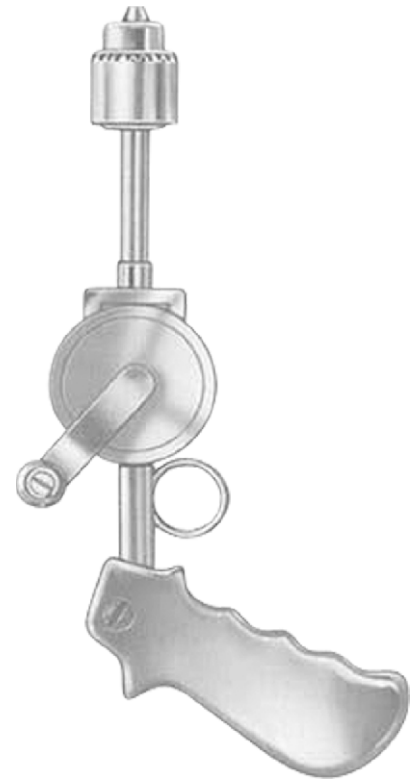

JJ-06-230

Page 131-147

- Dissecting and Tissue Forceps

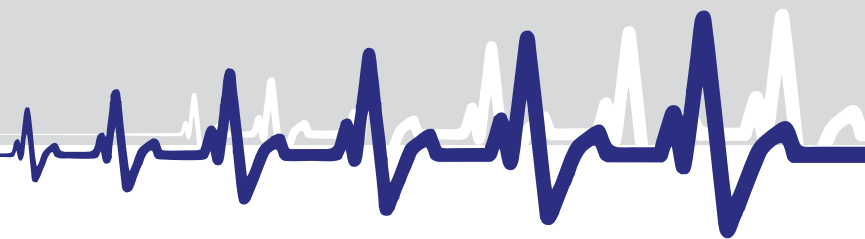

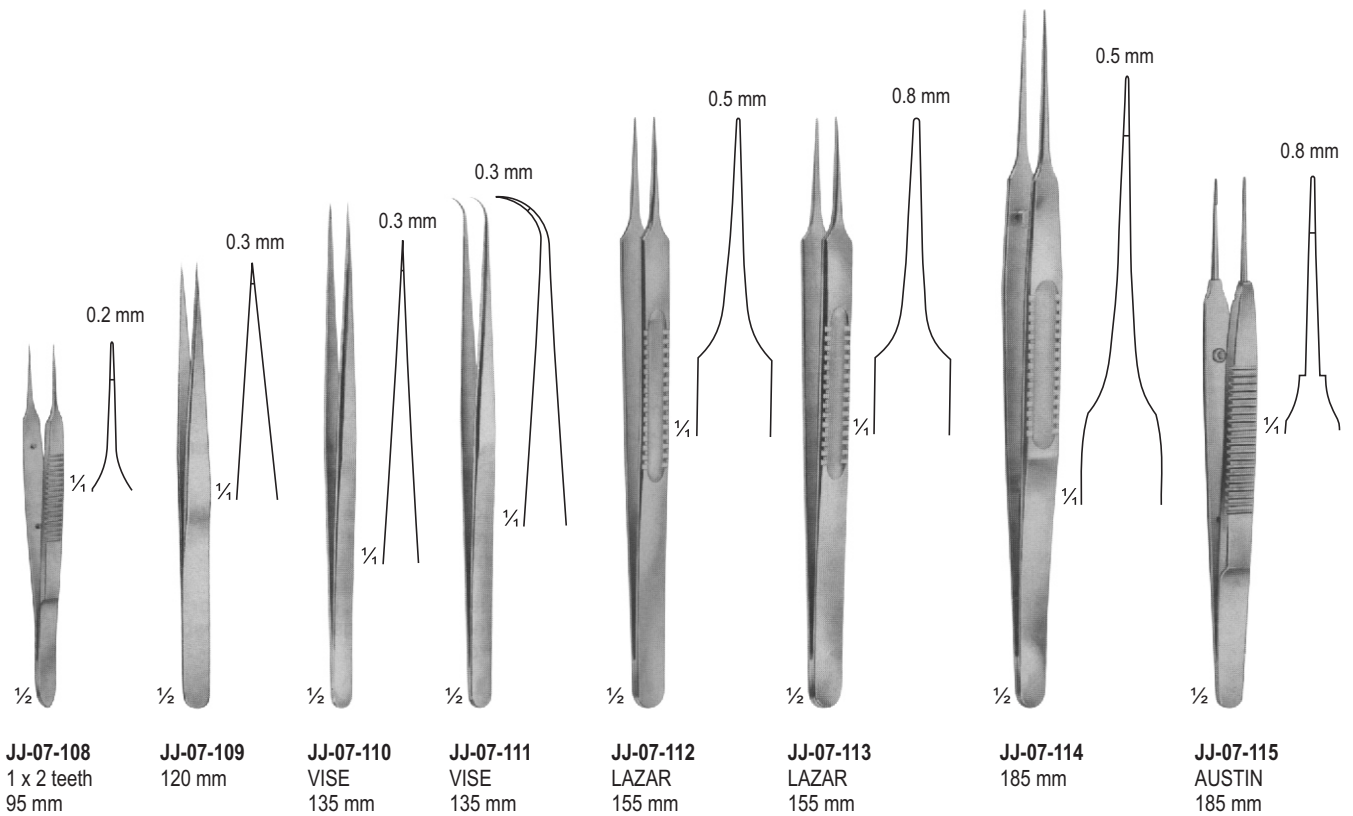
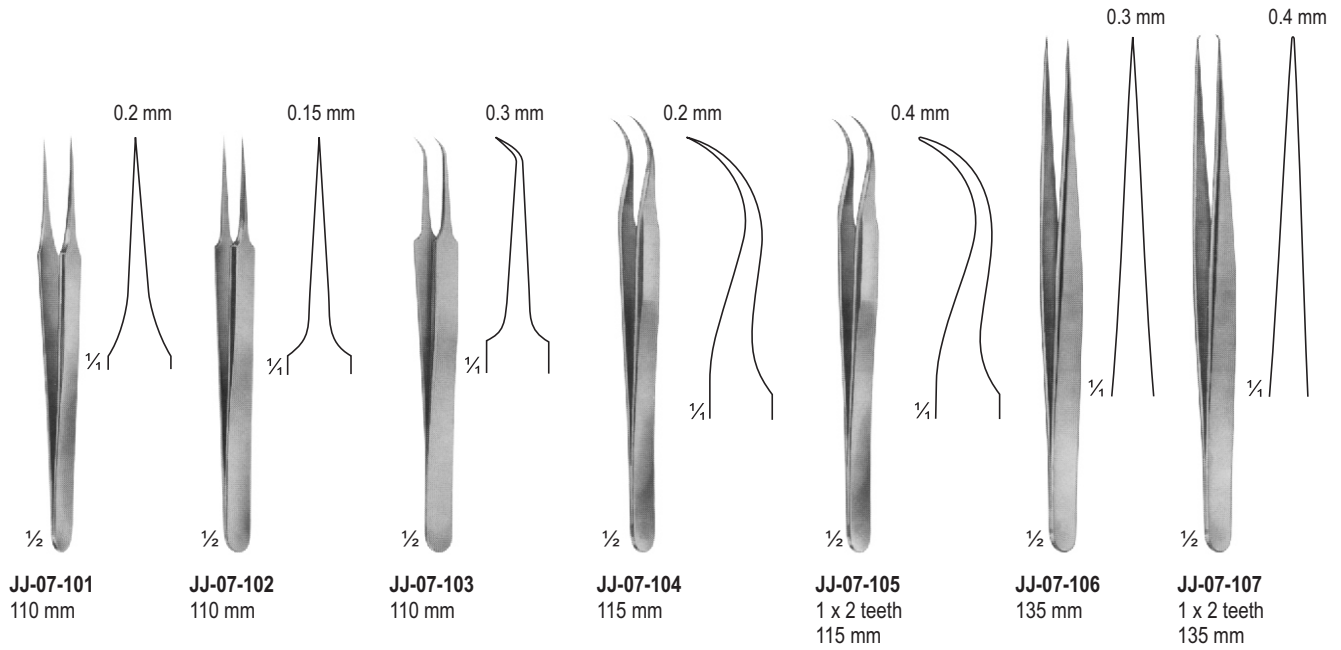

LIGATURE FORCEPS, MICRO FORCEPS (LIGHT PATTERNS)

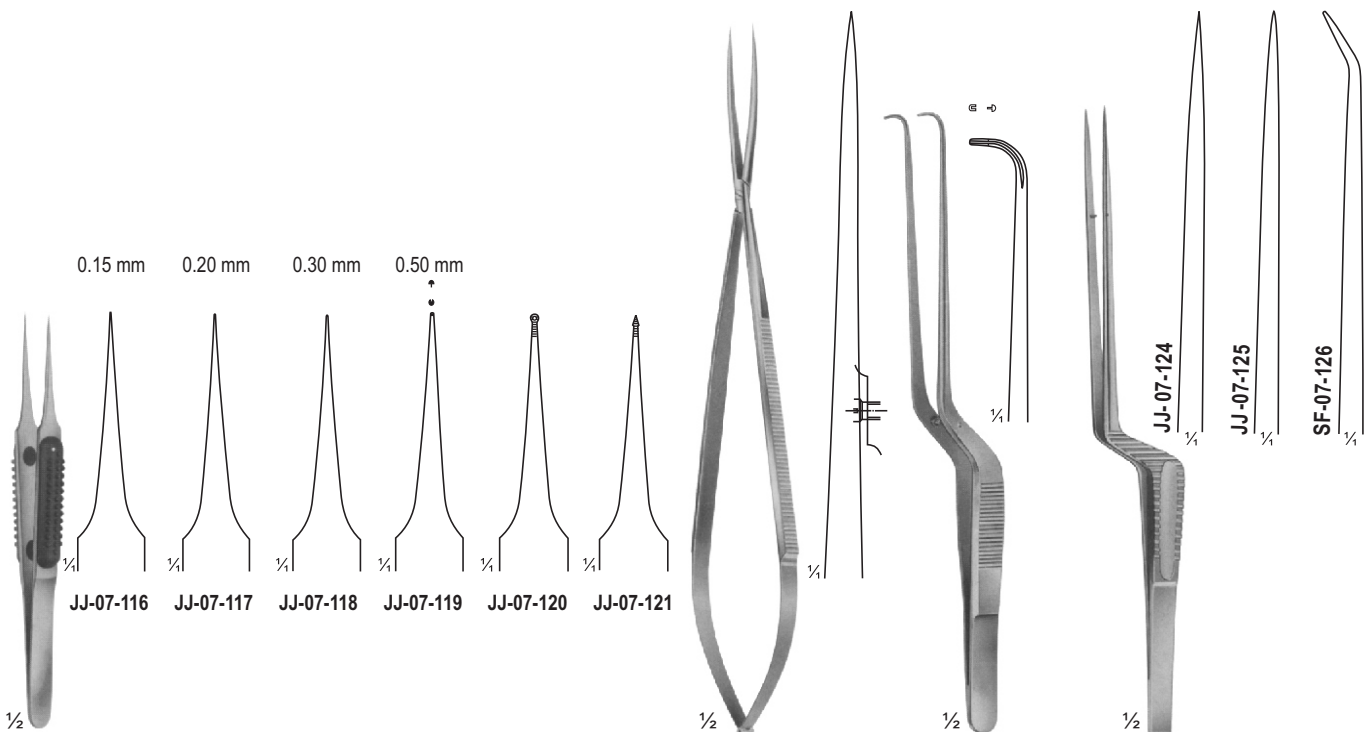

JJ-07-116 - JJ-07-121
MULLER
110 mm

JJ-07-122
LIGATURE FORCEPS
220 mm

JJ-07-123
YASARGIL
185 mm

JJ-07-124 - JJ-07-126
MICRO FORCEPS
185 mm

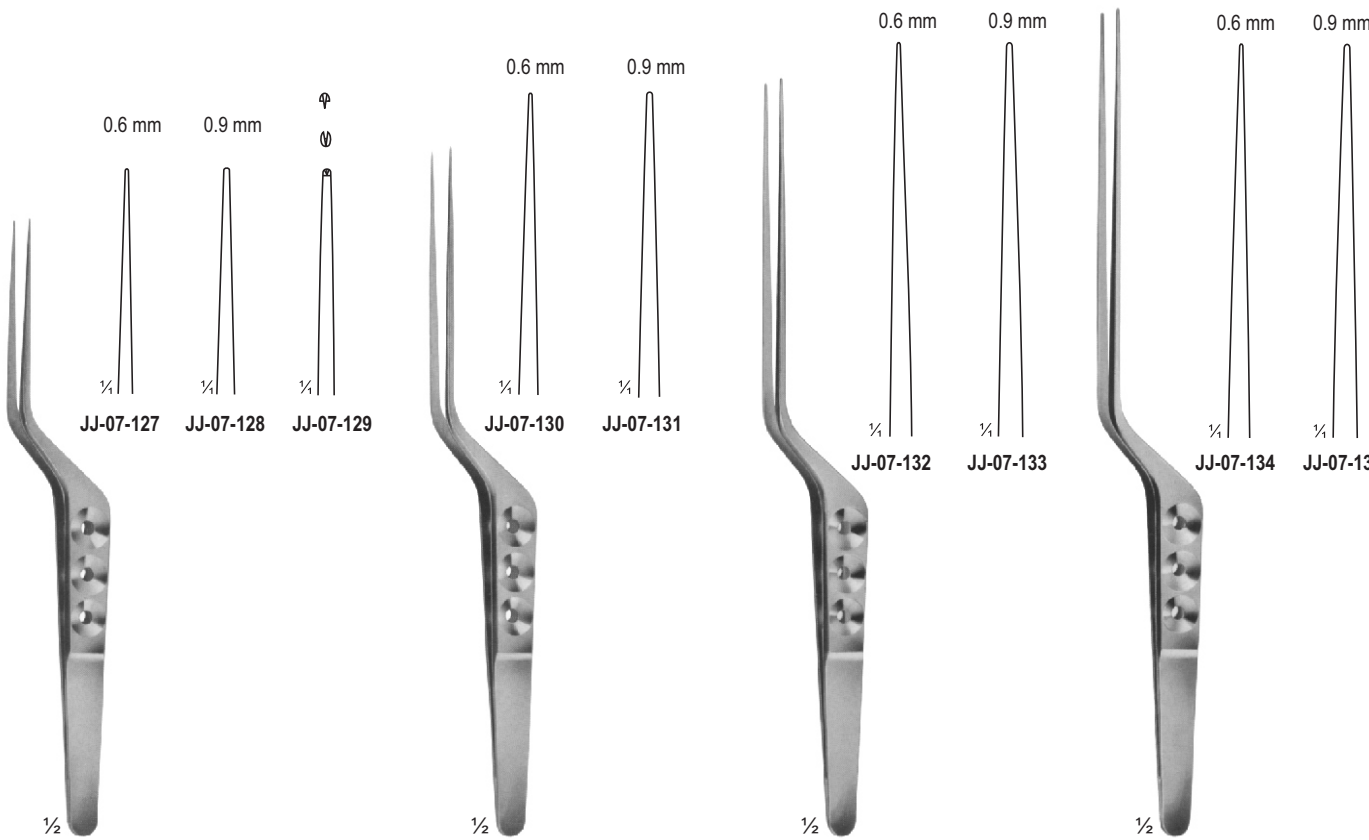

JJ-07-127 - JJ-07-129
YASARGIL
180 mm

JJ-07-130 - JJ-07-131
YASARGIL
200 mm

JJ-07-132 - JJ-07-133
YASARGIL
220 mm

JJ-07-134 - JJ-07-135
YASARGIL
240 mm

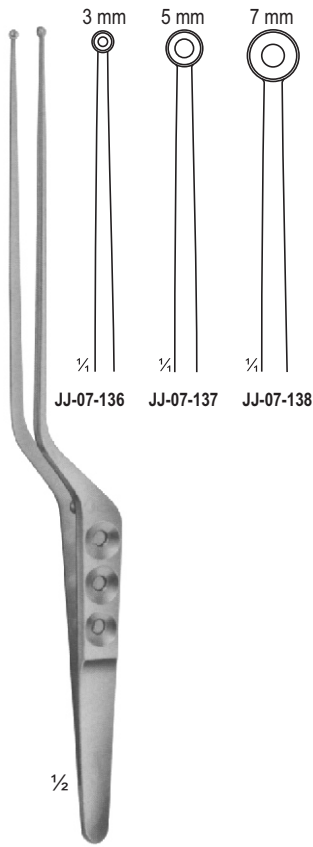

JJ-07-136 - JJ-07-138
YASARGIL-SAMI
Jaws Spoon-Shaped
240 mm

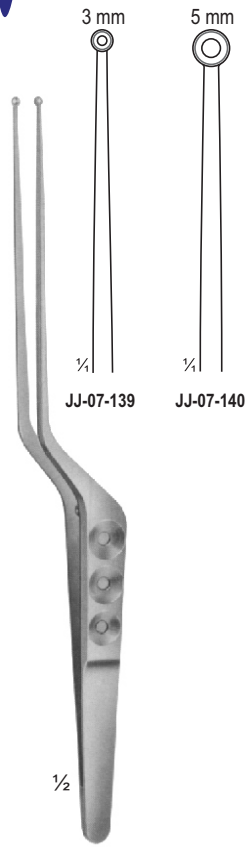

JJ-07-139 - JJ-07-140
YASARGIL
Jaws Spoon-Shaped
220 mm

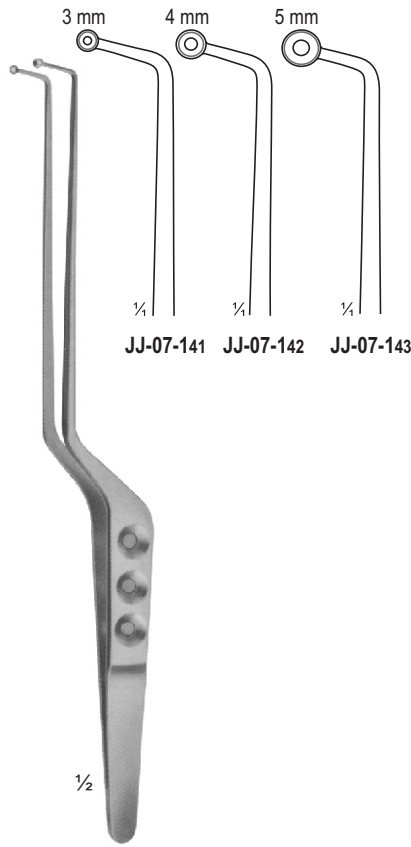

JJ-07-141 - CD-043
SAMII
Jaws Spoon-Shaped
230 mm

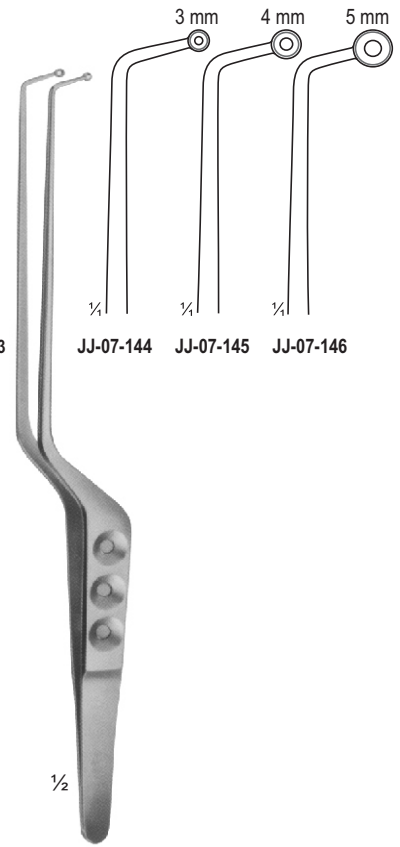

JJ-07-144 - JJ-07-146
SAMII
Jaws Spoon-Shaped
230 mm

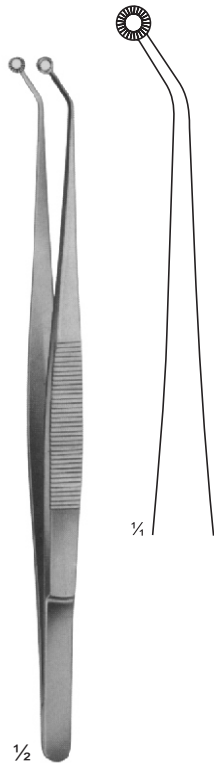

JJ-07-147
HUNT 1/2
Tumor and Vessel Forceps
200 mm

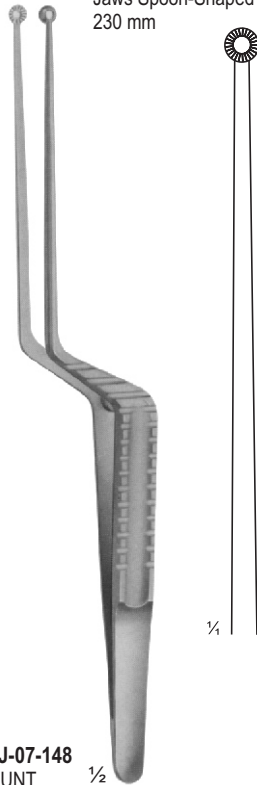

JJ-07-148
HUNT 1/2
Tumor and Vessel Forceps
200 mm

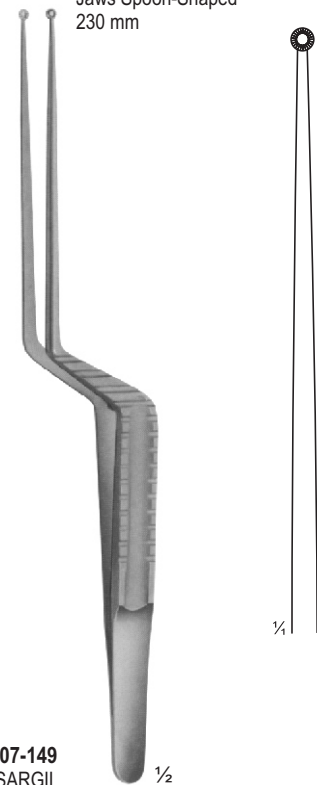

JJ-07-149
YASARGIL 1/2
Tumor and Vessel Forceps
200 mm

DELICATE, DISSECTING, MICROSCOPIC AND STERILIZING FORCEPS

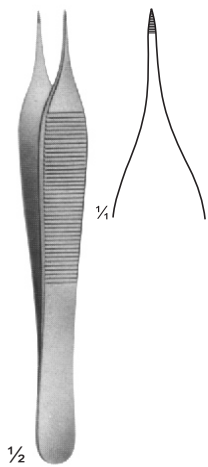

JJ-07-150
THORPE
 Corneal Forceps
 120 mm

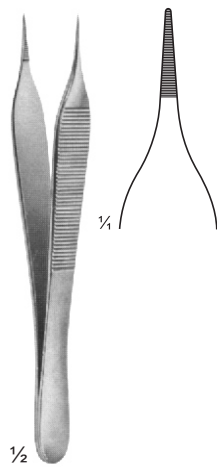

JJ-07-151
MICRO-ADSON
 120 mm

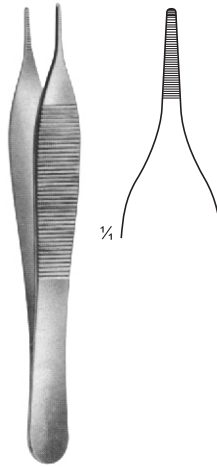

JJ-07-152
ADSON
 120 mm

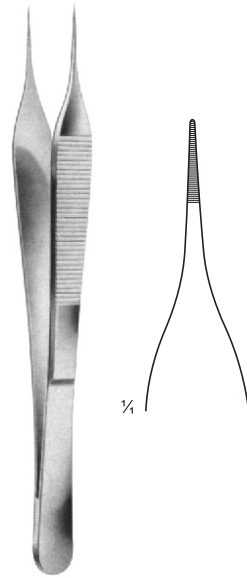

JJ-07-153
MICRO-ADSON
 150 mm

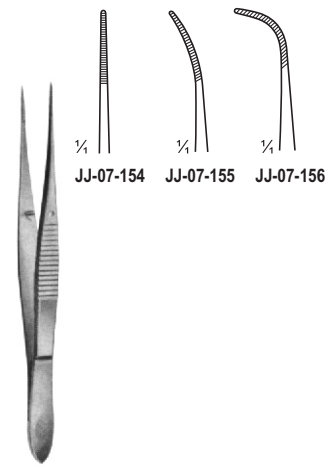

JJ-07-154 - JJ-07-156
 100 mm

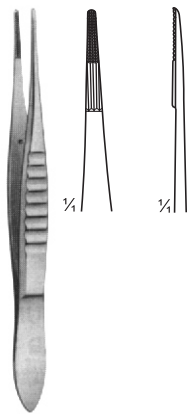

JJ-07-157
 110 mm

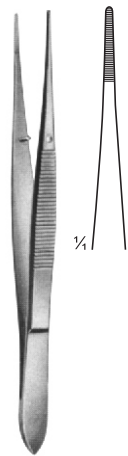

JJ-07-158
 115 mm



JJ-07-159
 90 mm



JJ-07-160
 105 mm



JJ-07-161
 115 mm



JJ-07-162
 130 mm



JJ-07-163
 145 mm

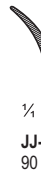

JJ-07-164
 90 mm



JJ-07-165
 105 mm



JJ-07-166
 115 mm



JJ-07-167
 130 mm



JJ-07-168
 145 mm

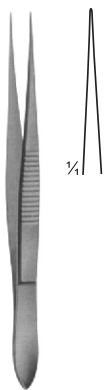

JJ-07-169
 100 mm

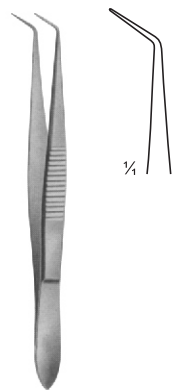

JJ-07-170
 100 mm

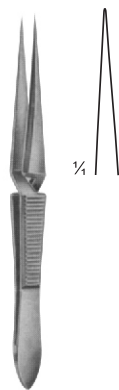

JJ-07-171
 100 mm

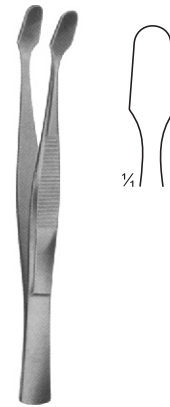

JJ-07-172
COVER GLASS FORCEPS
 105 mm



JJ-07-173
 160 mm

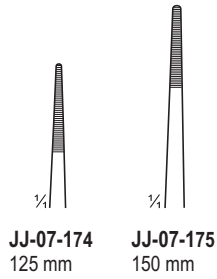

JJ-07-174
125 mm

JJ-07-175
150 mm

1/2

JJ-07-174 - JJ-07-175
SEMKEN

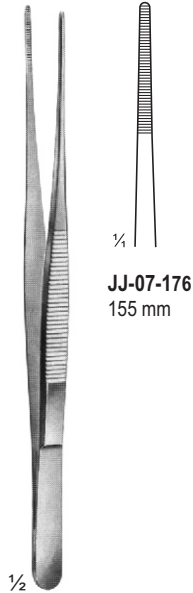

JJ-07-176
155 mm

1/2

JJ-07-176

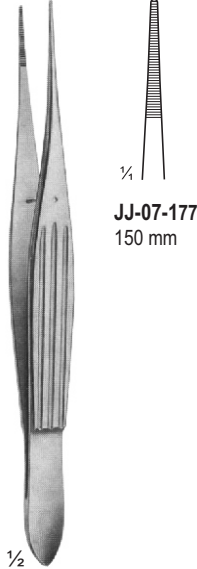

JJ-07-177
150 mm

1/2

JJ-07-177
MC INDOE

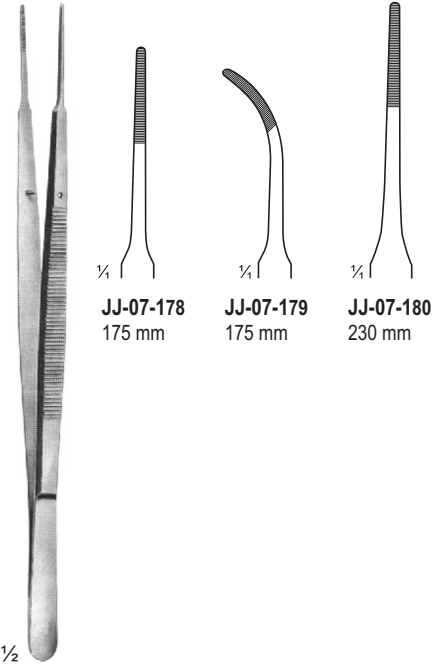

JJ-07-178
175 mm

JJ-07-179
175 mm

JJ-07-180
230 mm

1/2

JJ-07-178 - JJ-07-180
GERALD

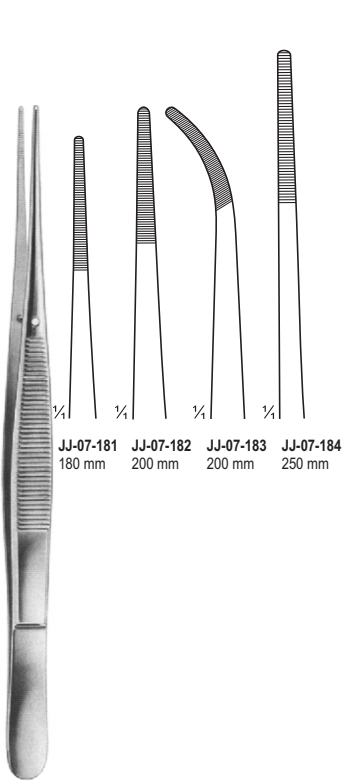

JJ-07-181
180 mm

JJ-07-182
200 mm

JJ-07-183
200 mm

JJ-07-184
250 mm

1/2

JJ-07-181 - JJ-07-184
CUSHING

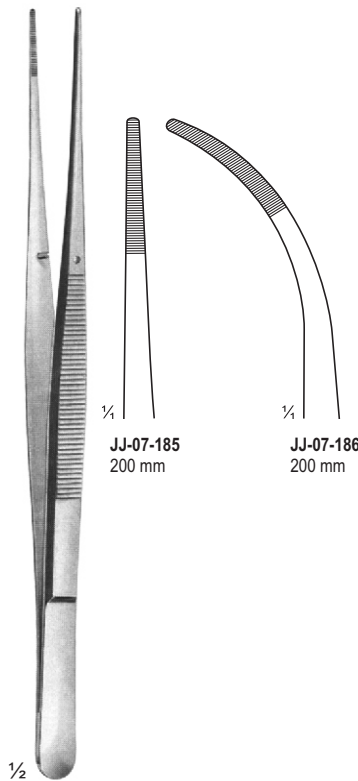

JJ-07-185
200 mm

JJ-07-186
200 mm

1/2

JJ-07-185 - JJ-07-186
BROPHY

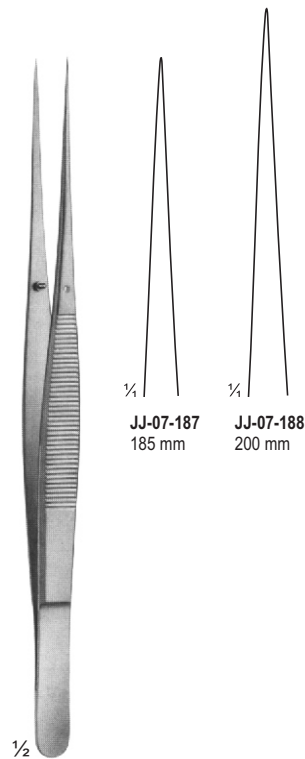

JJ-07-187
185 mm

JJ-07-188
200 mm

1/2

JJ-07-187 - JJ-07-188
SMOOTH JAWS

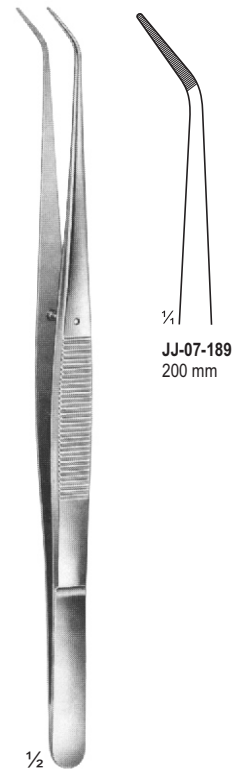

JJ-07-189
200 mm

1/2

JJ-07-189

DISSECTING FORCEPS

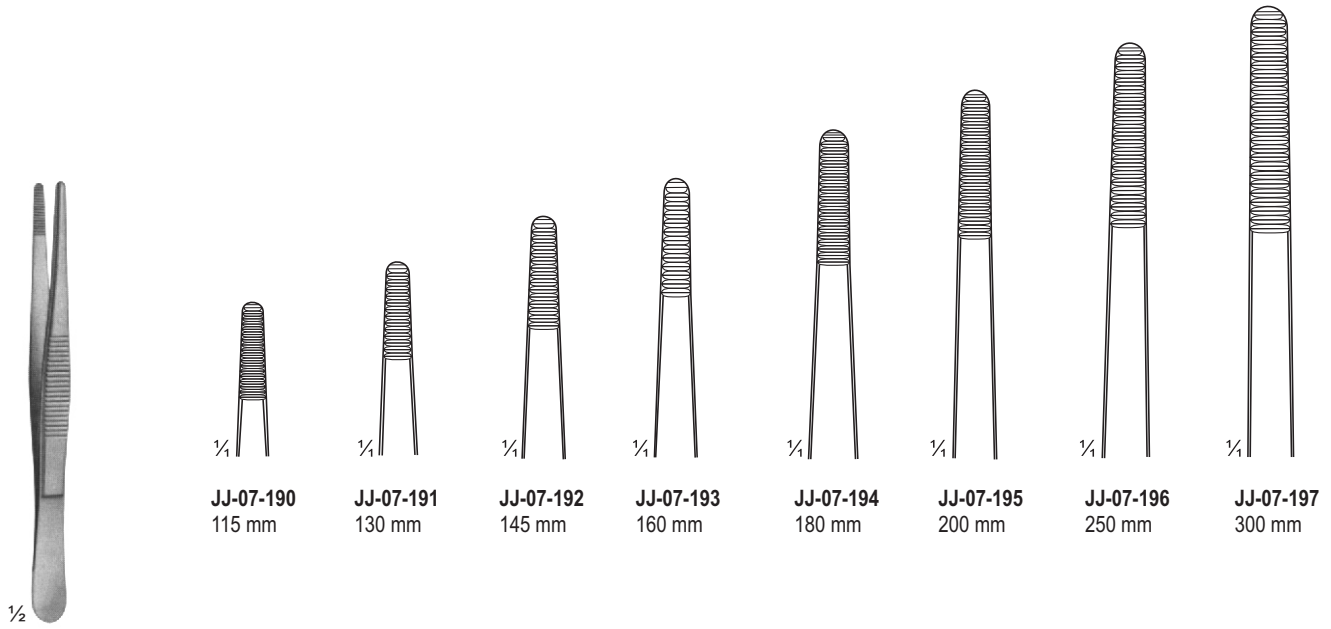

JJ-07-190 115 mm
JJ-07-191 130 mm
JJ-07-192 145 mm
JJ-07-193 160 mm
JJ-07-194 180 mm
JJ-07-195 200 mm
JJ-07-196 250 mm
JJ-07-197 300 mm

JJ-07-190 - JJ-07-197
STANDARD

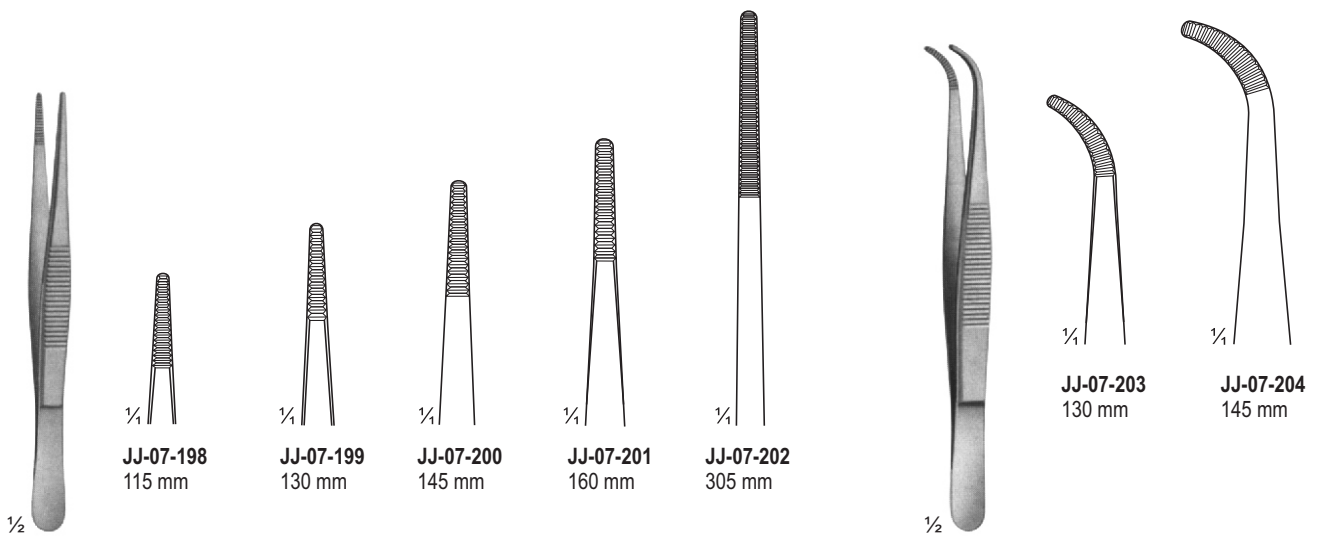

JJ-07-198 115 mm
JJ-07-199 130 mm
JJ-07-200 145 mm
JJ-07-201 160 mm
JJ-07-202 305 mm
JJ-07-203 130 mm
JJ-07-204 145 mm

JJ-07-198 - CD-102
MEDIUM

JJ-07-203 - JJ-07-204
MEDIUM

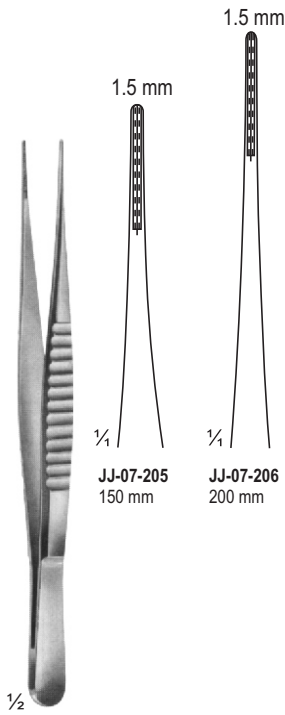

JJ-07-205 - JJ-07-206
DE BAKEY

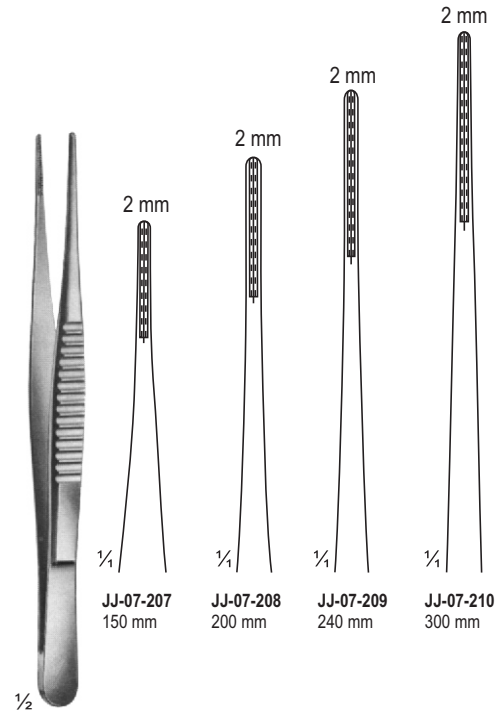

JJ-07-207 - JJ-07-210
DE BAKEY

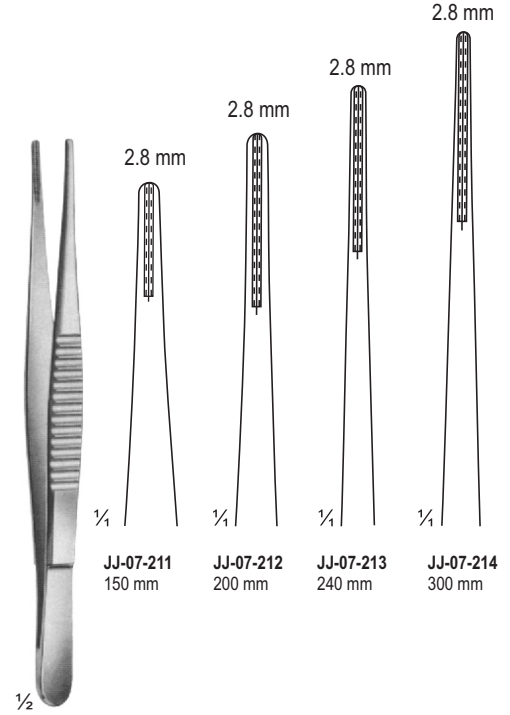

JJ-07-211 - JJ-07-214
DE BAKEY

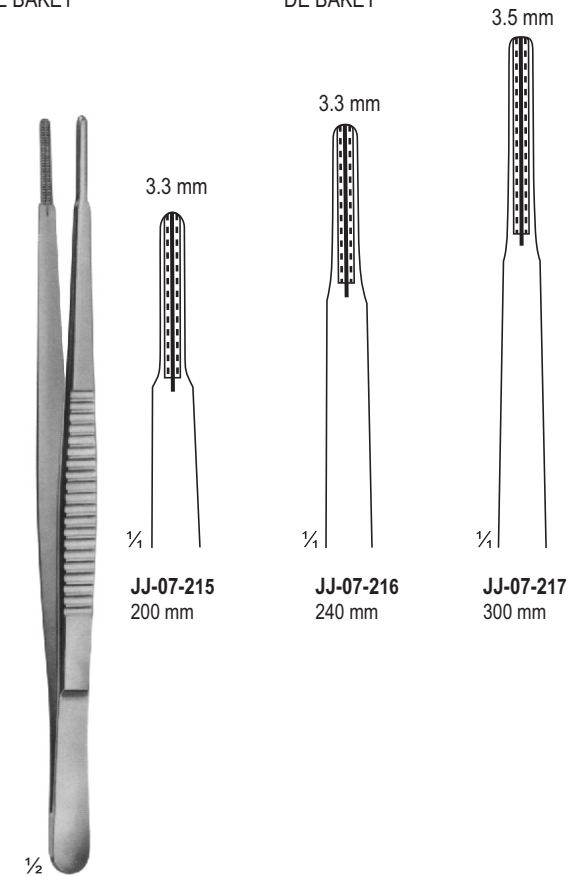

JJ-07-215 - JJ-07-217
DE BAKEY

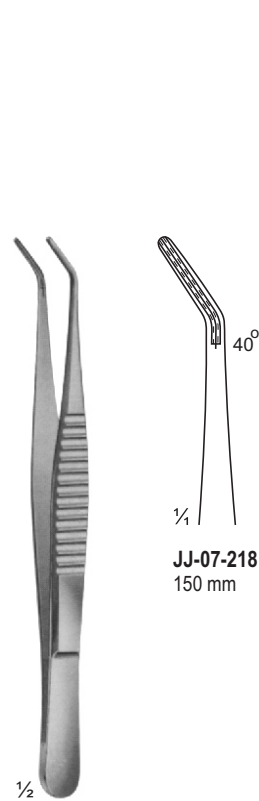

JJ-07-218
DE BAKEY

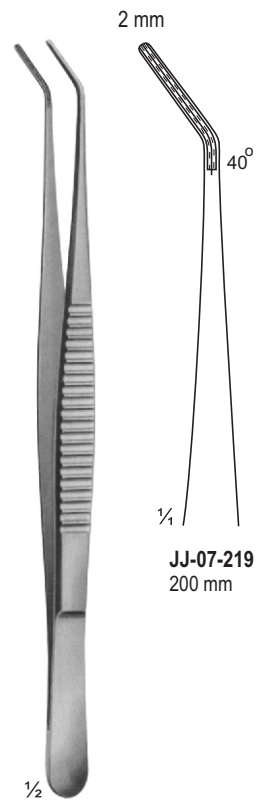

JJ-07-219
DE BAKEY

FORCEPS, BAYONET - SHAPED

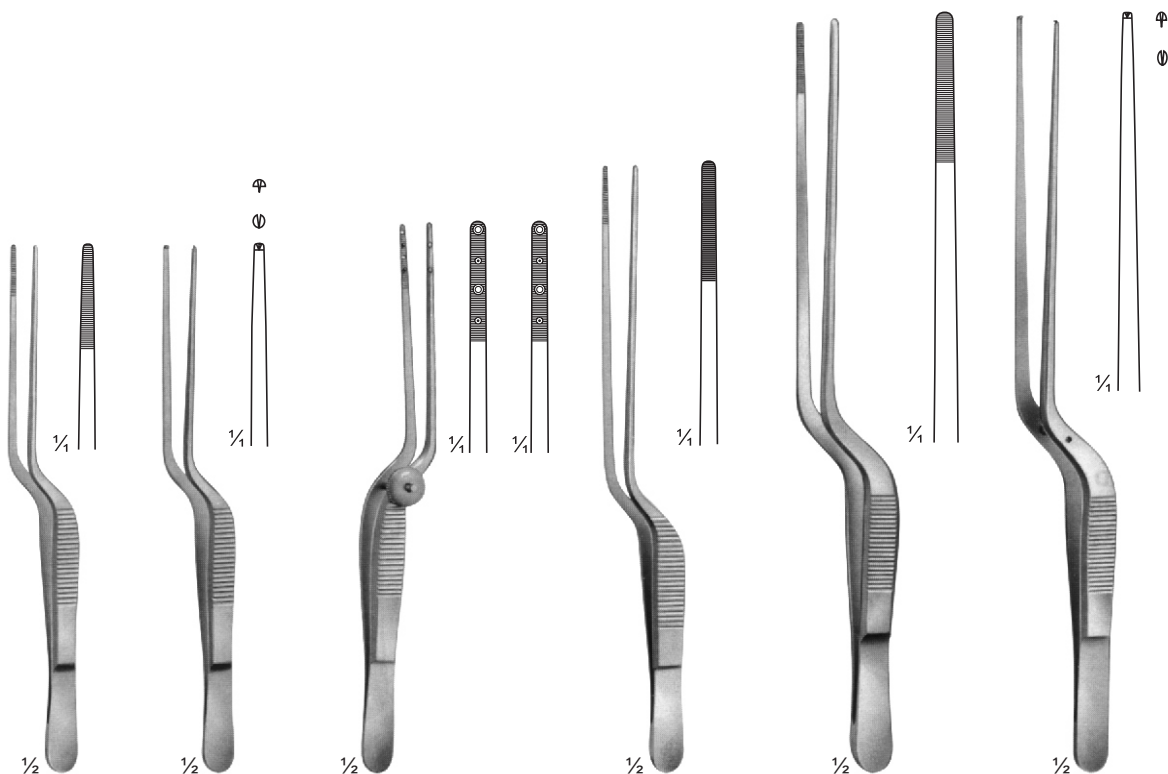

JJ-07-220
LUCAE
140 mm

JJ-07-221
LUCAE
1x2 teeth
140 mm

JJ-07-222
COTTLE
Forceps with
jaws toothed
and serrated
140 mm

JJ-07-223
JANSEN
160 mm

JJ-07-224
GRUENWALD
200 mm

JJ-07-225
1x2 teeth
200 mm

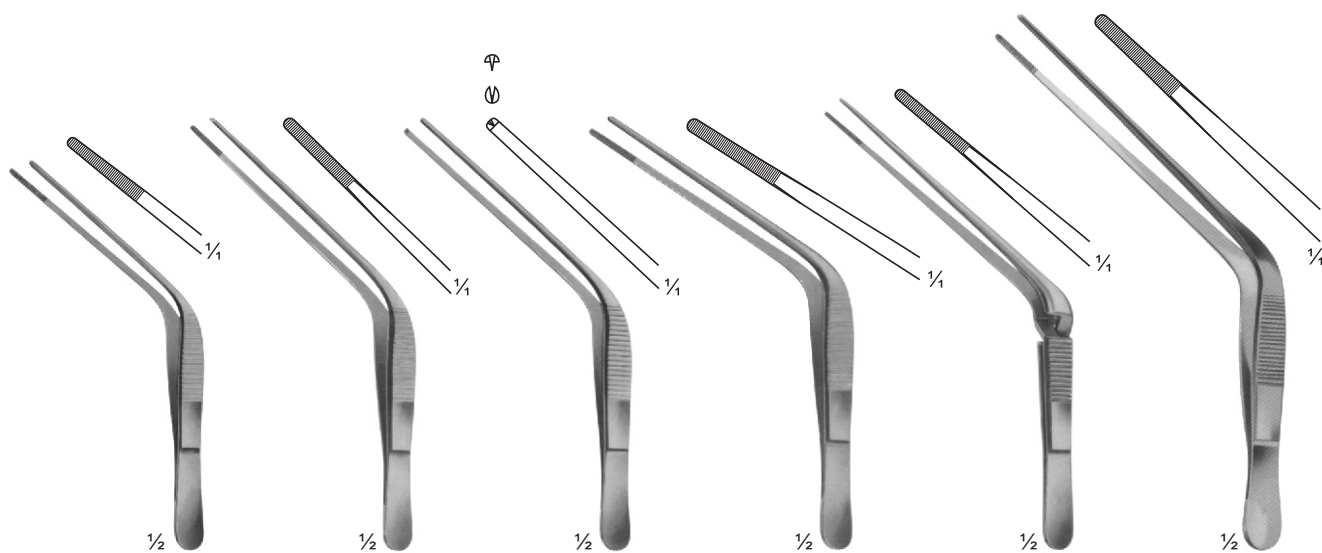

JJ-07-226
TROELTSCH
100 mm

JJ-07-227
TROELTSCH
115 mm

JJ-07-228
TROELTSCH
1X2 teeth
115 mm

JJ-07-229
WILDE
115 mm

JJ-07-230
TROELTSCH
Cross action
120 mm

JJ-07-231
TROELTSCH
140 mm

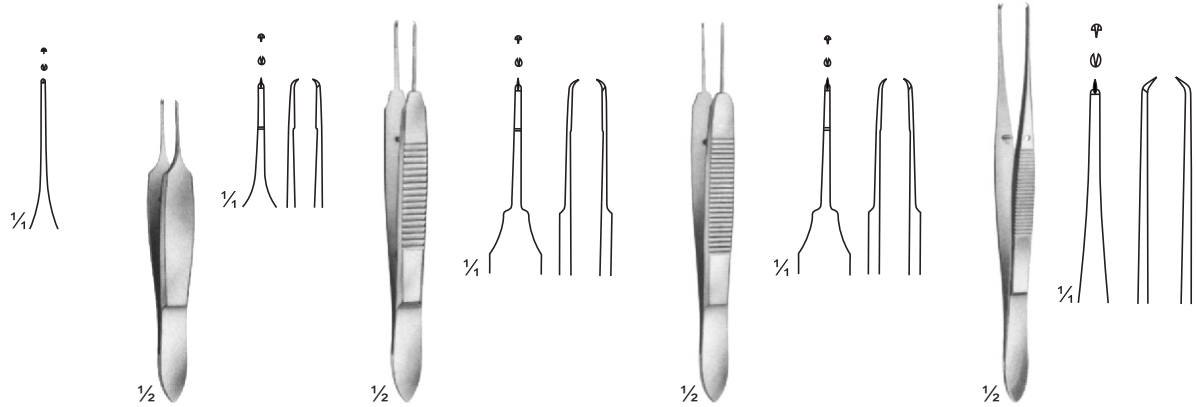

1/2
JJ-07-232
BISHOP-HARMON
85 mm

1/2
JJ-07-233
ST.MARTIN
80 mm

1/2
JJ-07-234
CASTROVIEJO
teeth 0.9 mm
100 mm

1/2
JJ-07-235
CASTROVIEJO
teeth 0.5 mm
100 mm

1/2
JJ-07-236
ELSCHING
110 mm

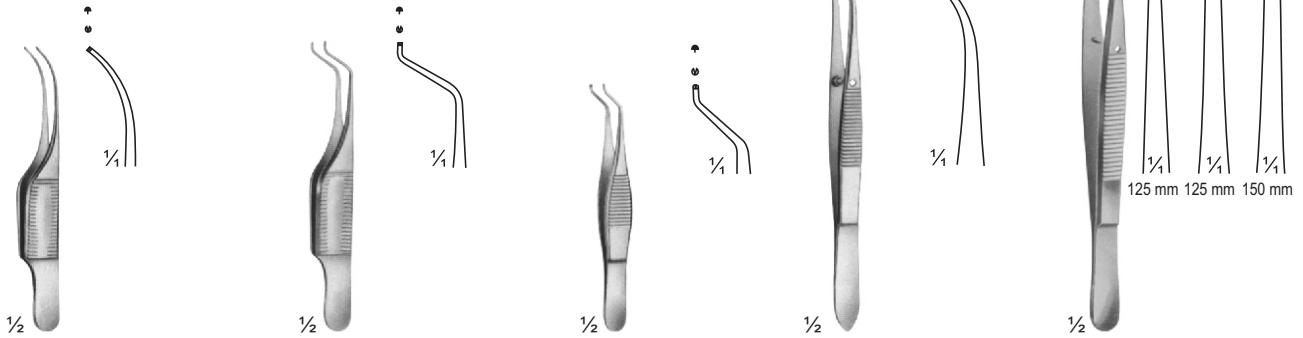

1/2
JJ-07-237
GILL
75 mm

1/2
JJ-07-238
GILL - HESS
75 mm

1/2
JJ-07-239
HESS
70 mm

1/2
JJ-07-240
ARRUGA
100 mm

1/2
JJ-07-241
SEMKEN

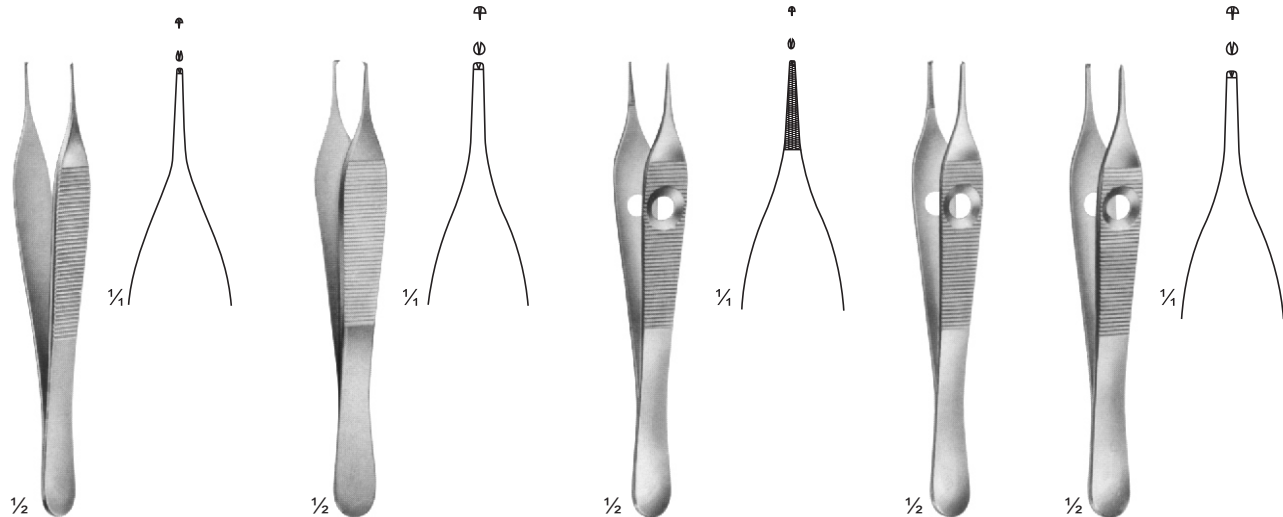

1/2
JJ-07-242
MICRO-ADSON
120 mm

1/2
JJ-07-243
ADSON
120 mm

1/2
JJ-07-244
ADSON
120 mm

1/2
JJ-07-245
ADSON
120 mm

1/2
JJ-07-246
ADSON
150 mm

LIGATURE FORCEPS, MICRO FORCEPS (LIGHT PATTERNS)

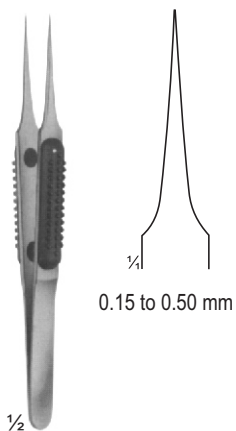

0.15 to 0.50 mm

MULLER
JJ-07-247
 110 mm 0.15 mm
JJ-07-248
 110 mm 0.20 mm
JJ-07-249
 110 mm 0.30 mm
JJ-07-250
 110 mm 0.50 mm
JJ-07-251

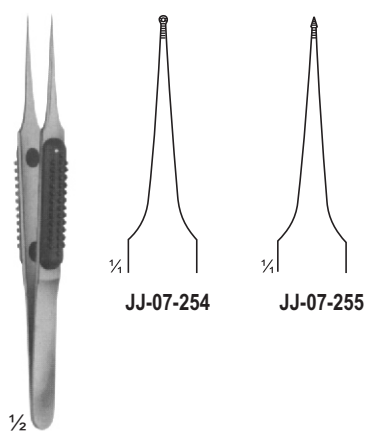

JJ-07-254 **JJ-07-255**

MULLER
JJ-07-252
 110 mm
JJ-07-253
 110 mm

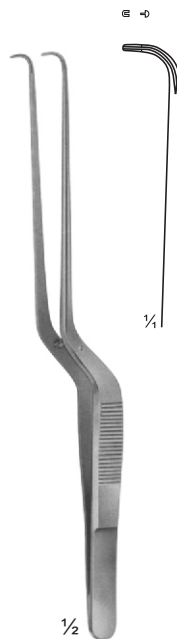

YASARGIL
JJ-07-256
 185 mm

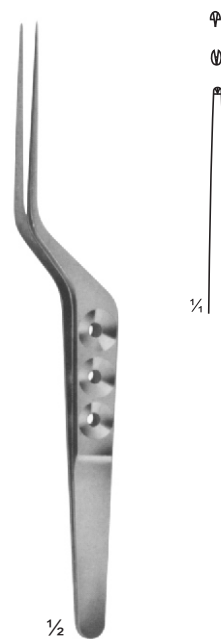

YASARGIL
JJ-07-257
 180 mm
JJ-07-258
 200 mm
JJ-07-259
 220 mm
JJ-07-260
 240 mm

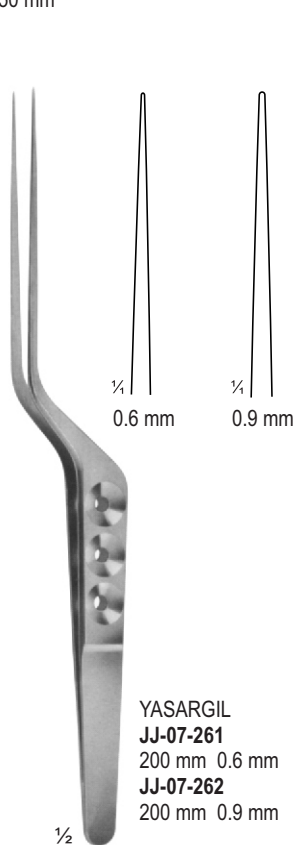

0.6 mm 0.9 mm

YASARGIL
JJ-07-261
 200 mm 0.6 mm
JJ-07-262
 200 mm 0.9 mm

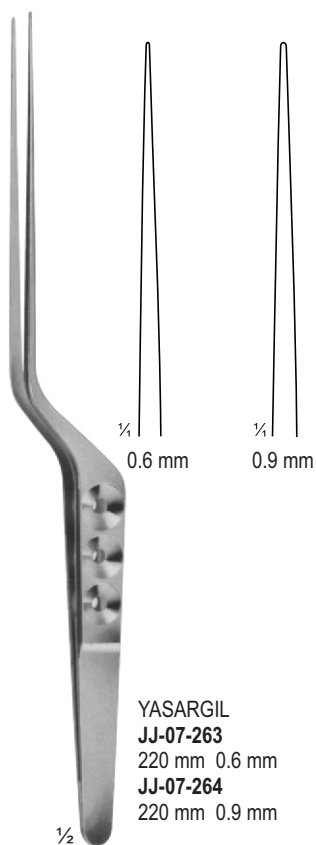

0.6 mm 0.9 mm

YASARGIL
JJ-07-263
 220 mm 0.6 mm
JJ-07-264
 220 mm 0.9 mm

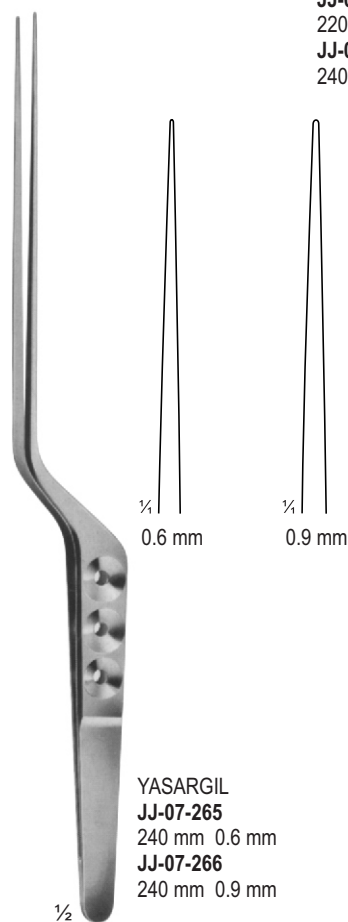

0.6 mm 0.9 mm

YASARGIL
JJ-07-265
 240 mm 0.6 mm
JJ-07-266
 240 mm 0.9 mm

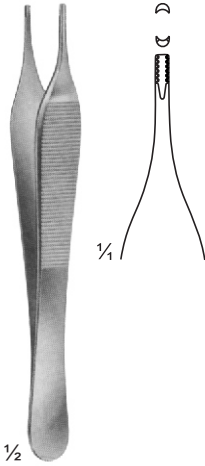

JJ-07-267
ADSON - BROWN
Non-traumatic
120 mm

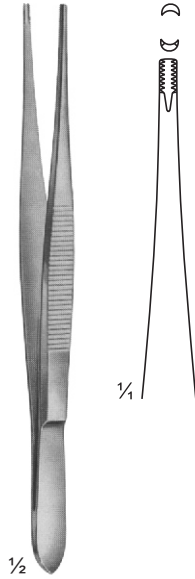

JJ-07-268
BROWN
120 mm

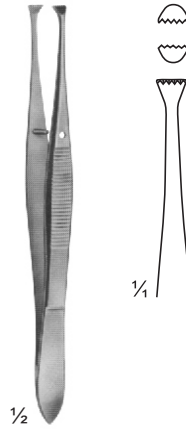

JJ-07-269
GRAEFE
110 mm

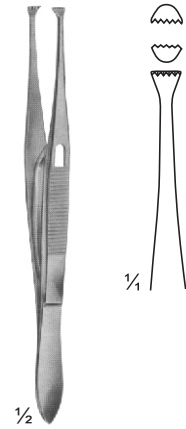

JJ-07-270
GRAEFE
With Catch
110 mm

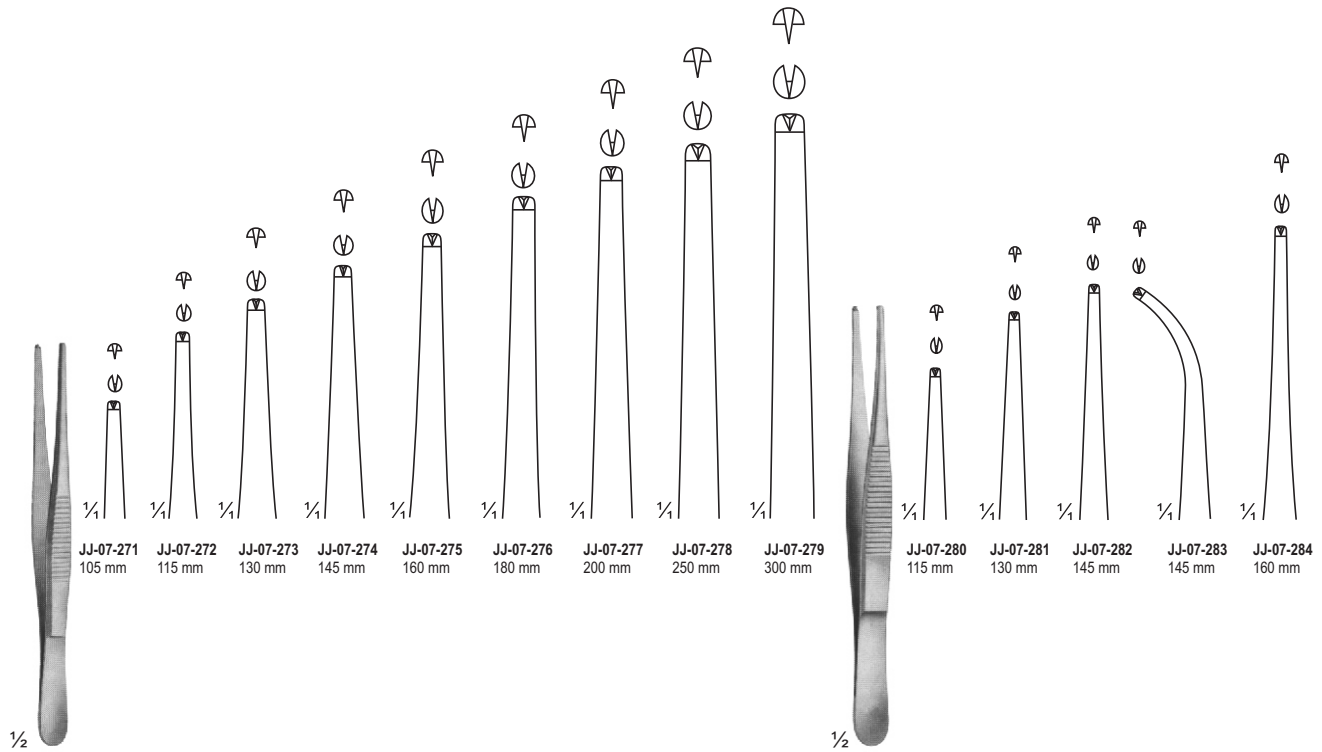

JJ-07-271 - JJ-07-279
STANDARD

JJ-07-271
105 mm

JJ-07-272
115 mm

JJ-07-273
130 mm

JJ-07-274
145 mm

JJ-07-275
160 mm

JJ-07-276
180 mm

JJ-07-277
200 mm

JJ-07-278
250 mm

JJ-07-279
300 mm

JJ-07-280
115 mm

JJ-07-281
130 mm

JJ-07-282
145 mm

JJ-07-283
145 mm

JJ-07-284
160 mm

TISSUE FORCEPS

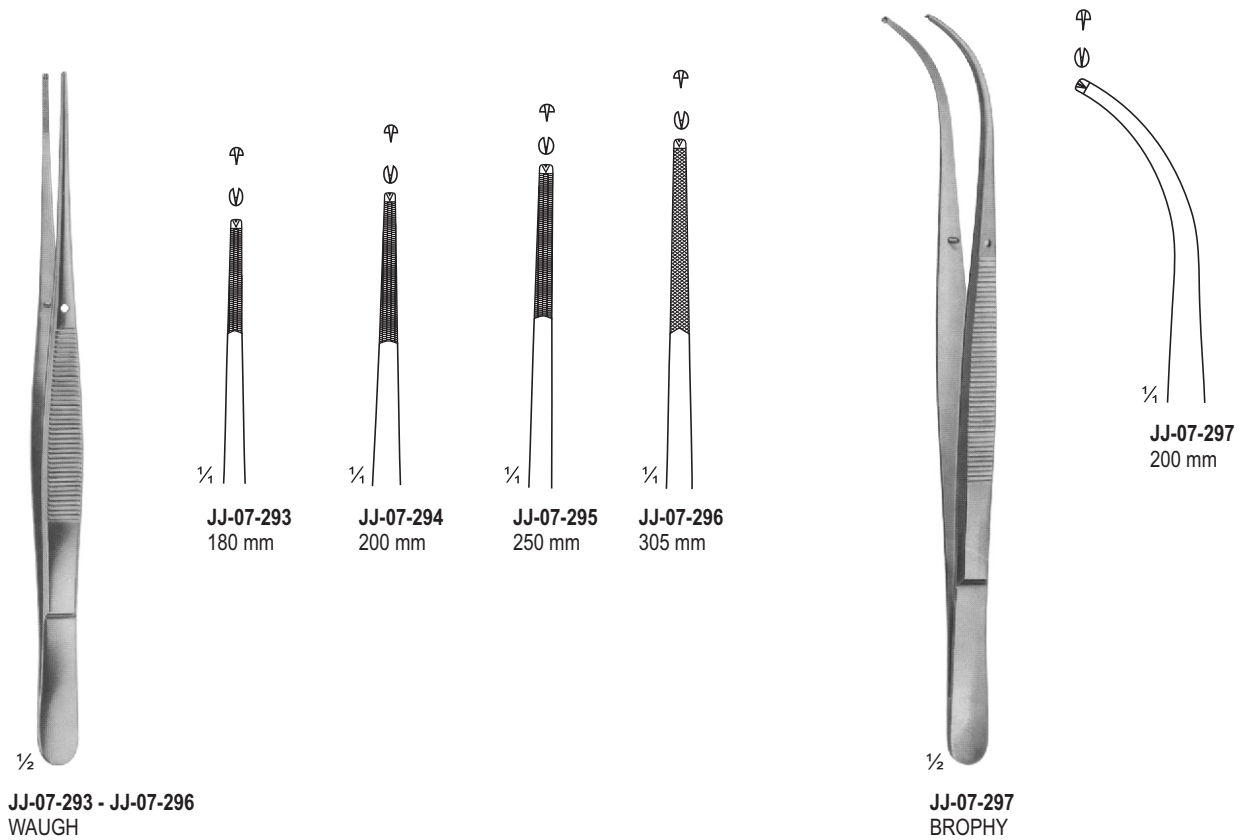
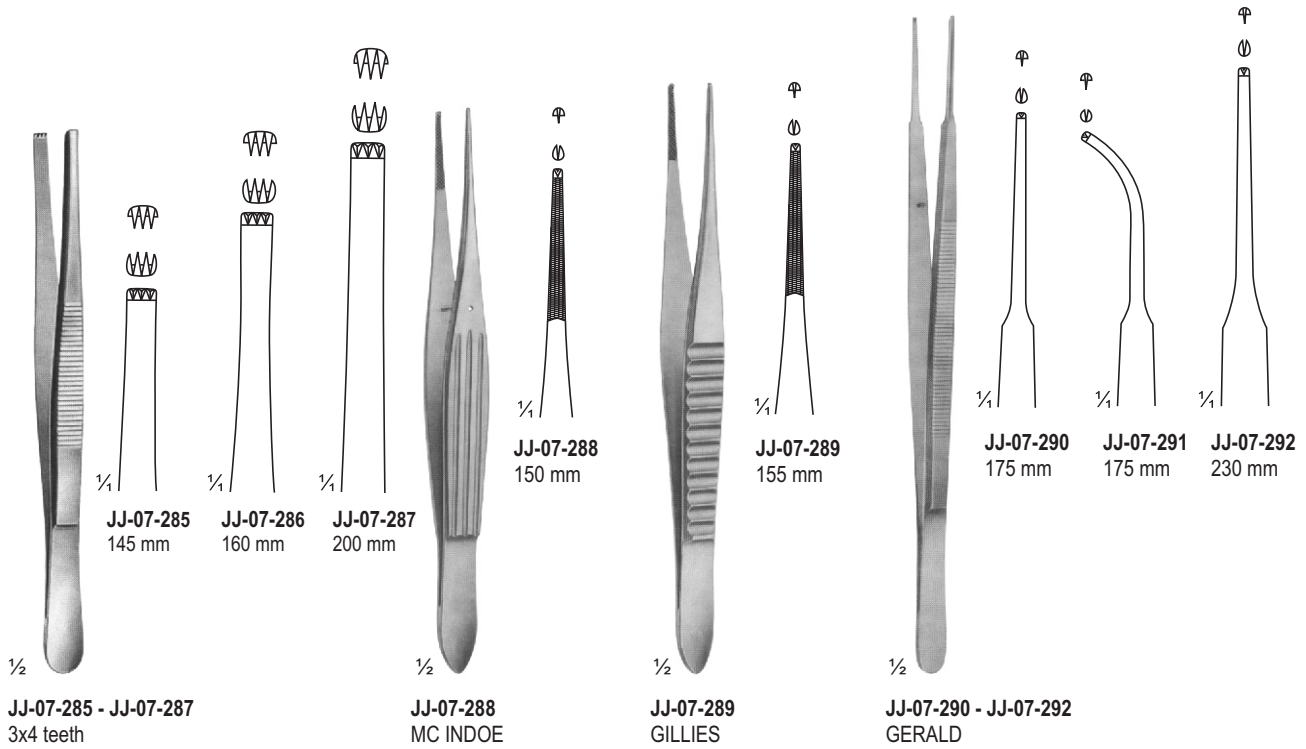

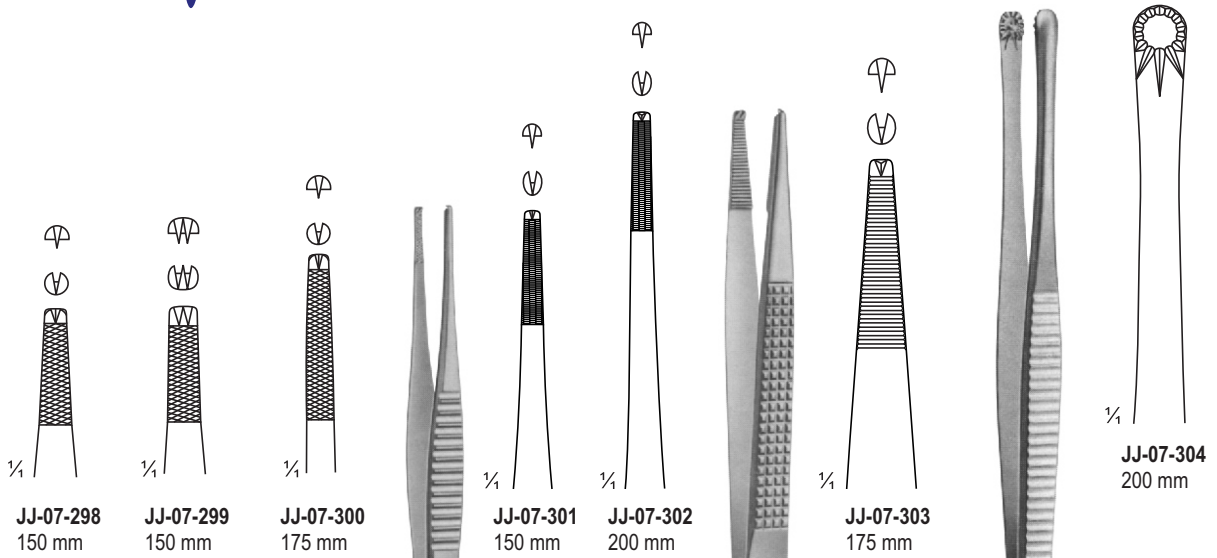

1/2
JJ-07-398 - JJ-07-300
LANE

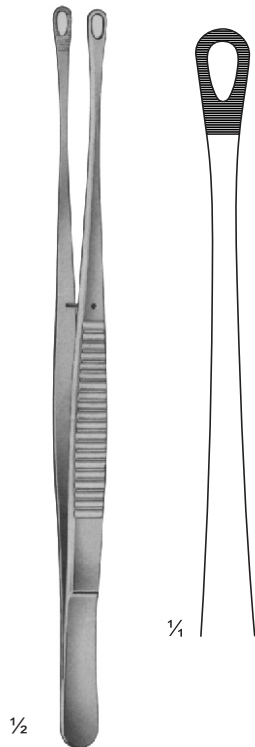

JJ-07-305
TUTTLE
Lung Dissecting Forceps
230 mm

1/2
JJ-07-301 - JJ-07-302
STRASSBURGER
MODELL

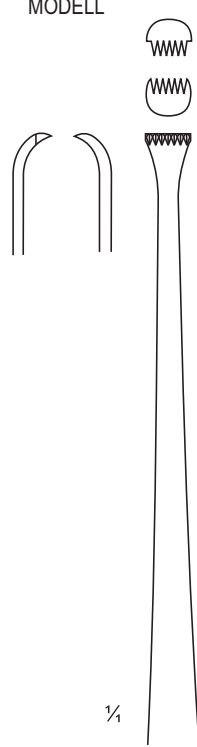

JJ-07-306
NELSON
Lung Dissecting Forceps
230 mm

1/2
JJ-07-303
BONNEY



JJ-07-307
DUVAL
Intestinal Forceps
140 mm

1/2
JJ-07-304
RUSS.MODELL
200 mm

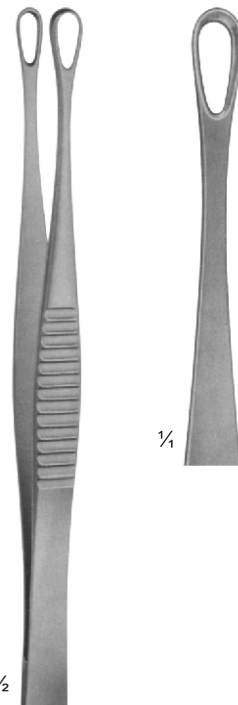

JJ-07-308
DENIS-BROWNE
Intestinal Forceps
190 mm

SPLINTER AND CILIA FORCEPS

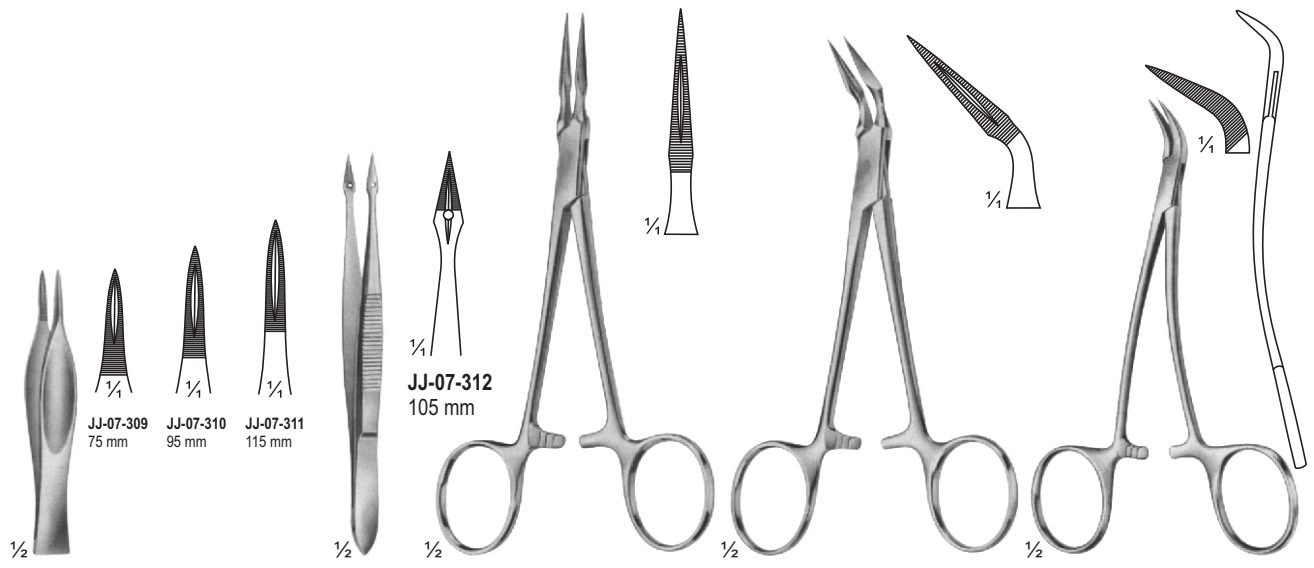

JJ-07-309 - JJ-07-311
FEILCHENFELD

JJ-07-312
HUNTER

JJ-07-313
STIEGLITZ
140 mm

JJ-07-314
STIEGLITZ
140 mm

JJ-07-315
PEET
120 mm

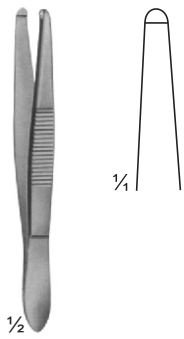

JJ-07-316
BEER
85 mm

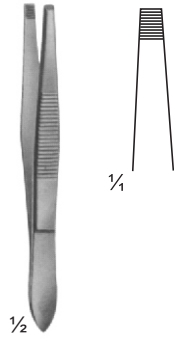

JJ-07-317
85 mm

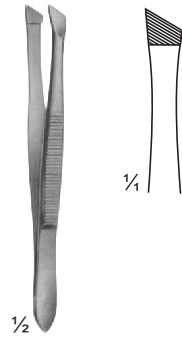

JJ-07-318
85 mm

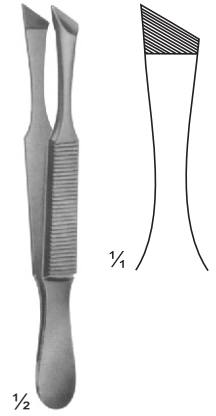

JJ-07-319
105 mm

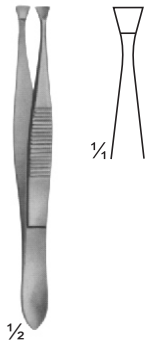

JJ-07-320
105 mm

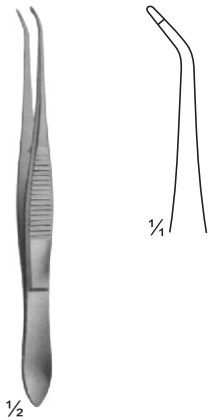

JJ-07-321
SAUPE
105 mm

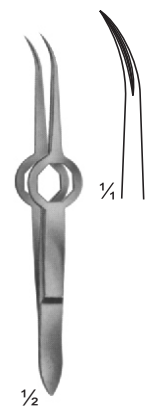

JJ-07-322
SCHAAF
95 mm

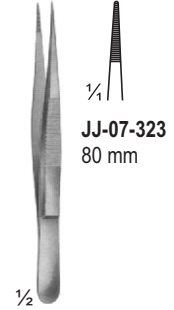

JJ-07-323
80 mm

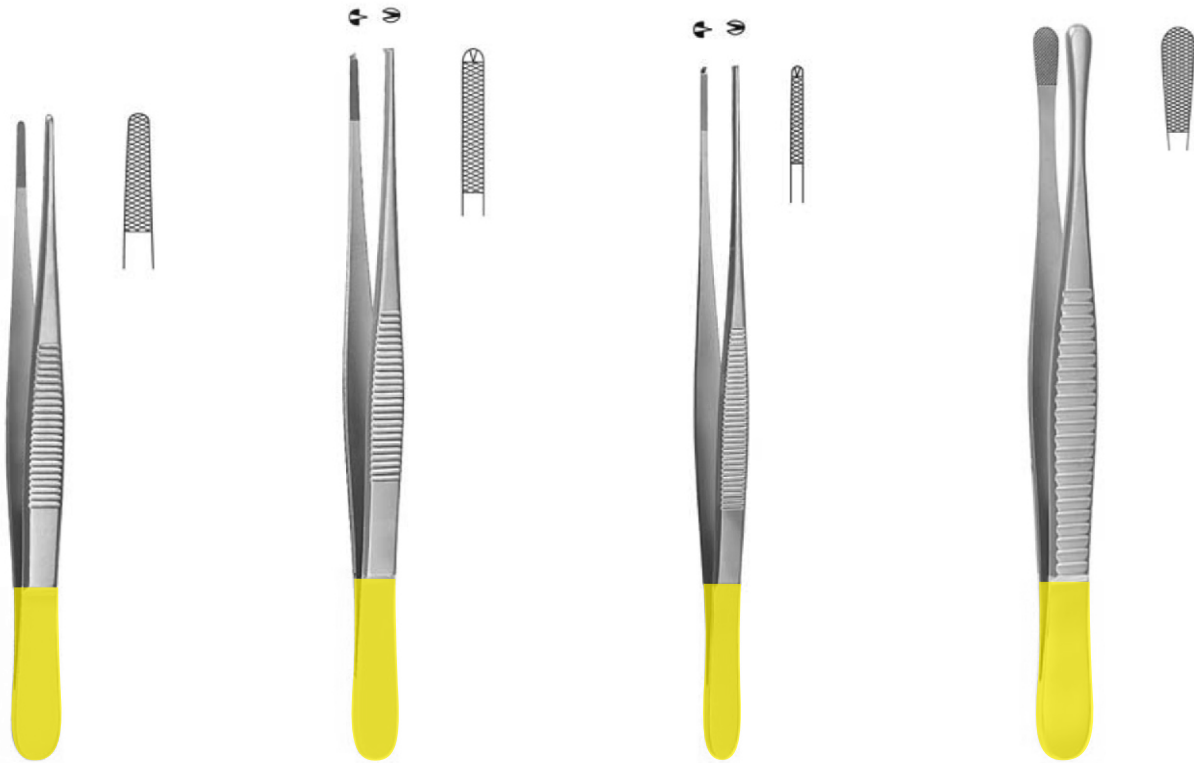

STANDARD

- JJ-07-324** 14.5 cm, 5 3/4"
- JJ-07-325** 16.0 cm, 6 1/4"
- JJ-07-326** 18.0 cm, 7"
- JJ-07-327** 20.0 cm, 8"
- JJ-07-328** 25.0 cm, 10"
- JJ-07-329** 30.0 cm, 12"

STANDARD

- JJ-07-330** 14.5 cm, 5 3/4"
- JJ-07-331** 16.0 cm, 6 1/4"
- JJ-07-332** 18.0 cm, 7"
- JJ-07-333** 20.0 cm, 8"
- JJ-07-334** 25.0 cm, 10"
- JJ-07-335** 30.0 cm, 12"

STANDARD

- JJ-07-336** 12.5 cm, 5"
- JJ-07-337** 15.0 cm, 6"

STANDARD

- JJ-07-338** 15.0 cm, 6"
- JJ-07-339** 23.0 cm, 9"
- JJ-07-340** 25.0 cm, 10"

FORCEPS WITH TUNGSTEN CARBIDE INSERTS



GILLIES
JJ-07-341
 15.0 cm, 6"



MC INDOE
JJ-07-342
 15.0 cm, 6"

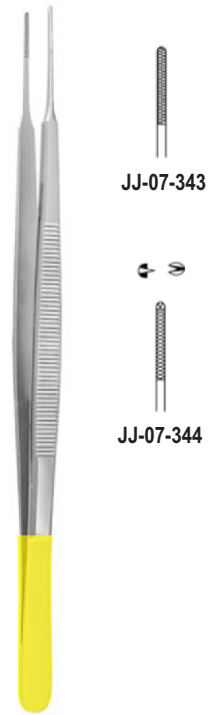

GERALD
JJ-07-343 - JJ-07-344
 17.0 cm, 6 3/4"



POTTS-SMITH
JJ-07-345 15.0 cm, 6"
JJ-07-346 18.0 cm, 7"
JJ-07-347 20.0 cm, 8"



BONNEY
JJ-07-348
 17.5 cm, 6 5/8"

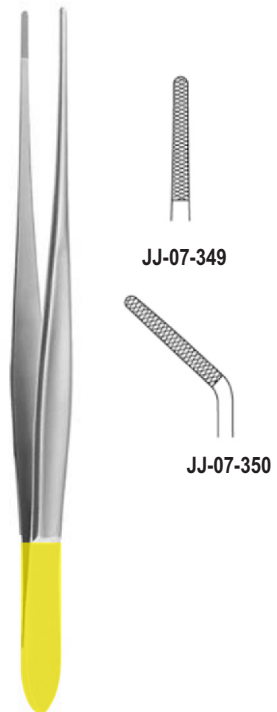

CUSHING
JJ-07-349 - JJ-07-350
 17.5 cm, 6 5/8"



CUSHING-TAYLOR
JJ-07-351
 18.0 cm, 7"

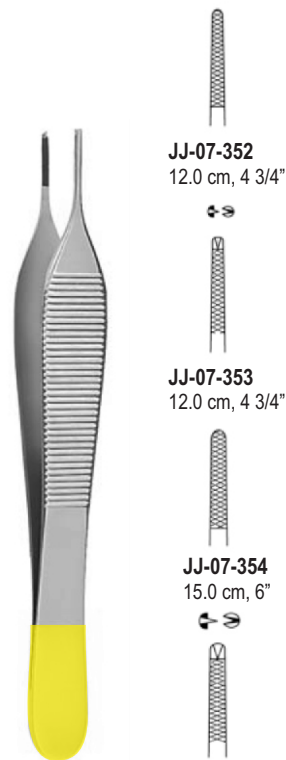

ADSON
JJ-07-352 - JJ-07-355
 17.5 cm, 6 5/8"

JJ-07-352
 12.0 cm, 4 3/4"
JJ-07-353
 12.0 cm, 4 3/4"
JJ-07-354
 15.0 cm, 6"
JJ-07-355
 15.0 cm, 6"



DE BAKEY
JJ-07-356
150 mm
JJ-07-357
200 mm
JJ-07-358
250 mm

DE BAKEY
JJ-07-356 - JJ-07-361



DE BAKEY
JJ-07-359
150 mm
JJ-07-360
200 mm
JJ-07-361
250 mm



JABOMA-TC
JJ-07-362
180 mm



JABOMA-TC
JJ-07-363
180 mm

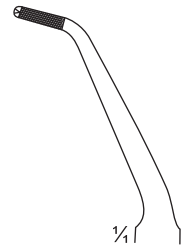

JABOMA-TC
JJ-07-364
180 mm



OBWEGESER
JJ-07-365
160 mm



OBWEGESER
JJ-07-366
180 mm



MERIEM
JJ-07-367



POTTS-NEVINS
JJ-07-368
180 mm

Page 148–156

- Obstetrics
- Tracheotomy

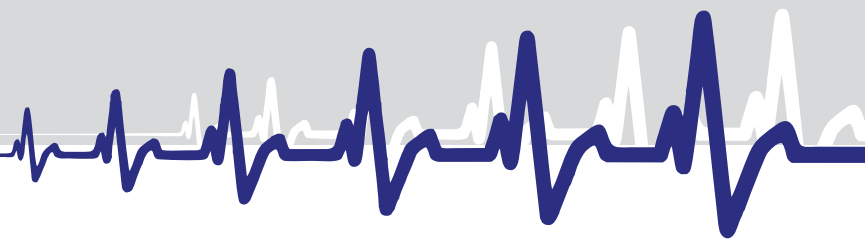



JJ-08-101
THOLE
for internal and external measurements, graduated in centimeters



JJ-08-102
DE LEE
graduated in centimeters and inches

for internal measurements between symphysis and promontory

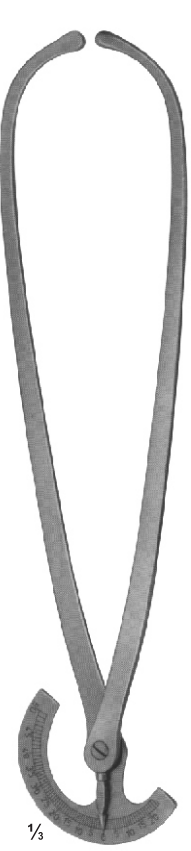

JJ-08-103
COLLIN
graduated in centimeters

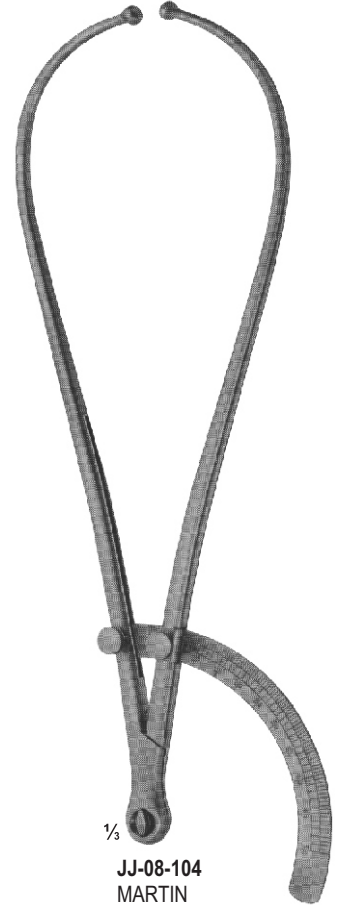

JJ-08-104
MARTIN
graduated in centimeters



JJ-08-105
COLLIN
graduated in centimeters

The additional straight arm can be replaced. The pelvimeter with straight arm is used for localisation of the portio vaginalis uteri and of vaginal metastasis.



JJ-08-106
BREISKY
graduated in centimeters

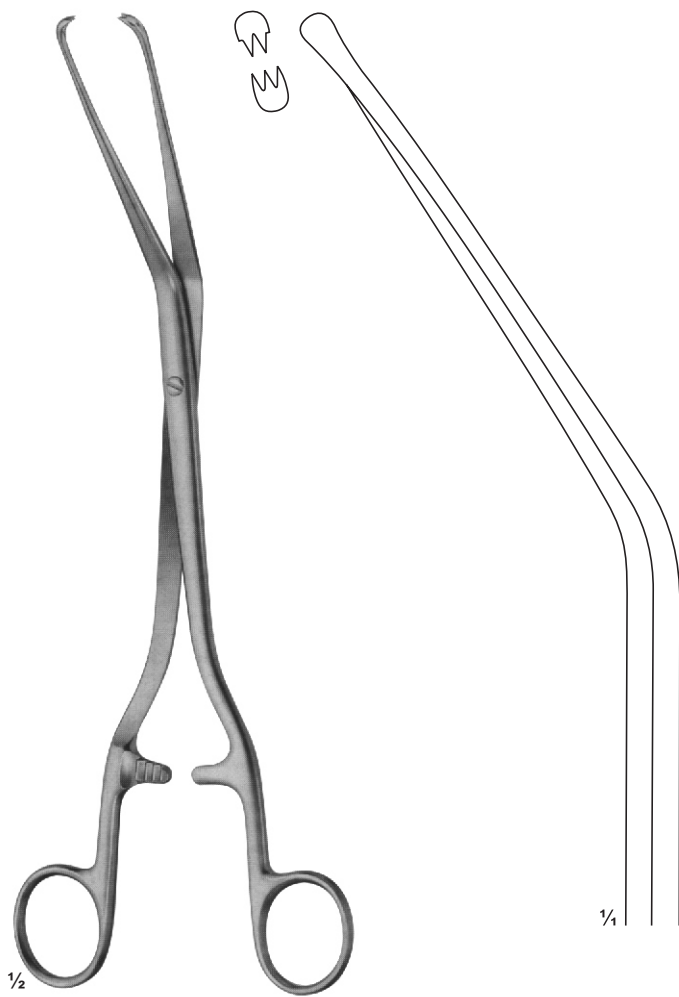

JJ-08-107
HERFF
puncturing forceps
225 mm



JJ-08-108
IOWA
puncturing forceps
260 mm



JJ-08-109
SIMPSON-BRAUN
305mm

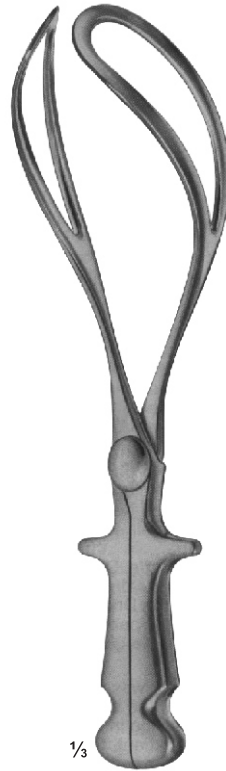

JJ-08-110
355 mm

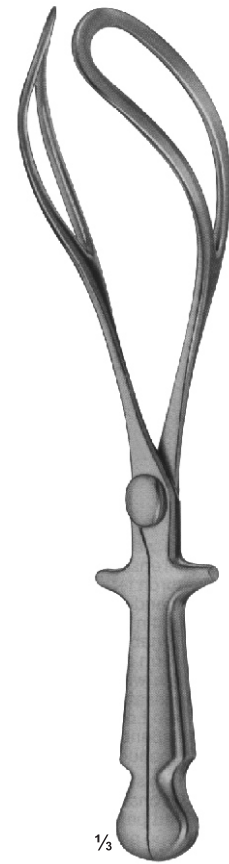

JJ-08-111
400 mm



JJ-08-112
SIMPSON-BRAUN
305mm

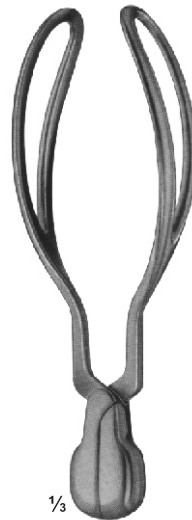

JJ-08-113
SIMPSON
235mm

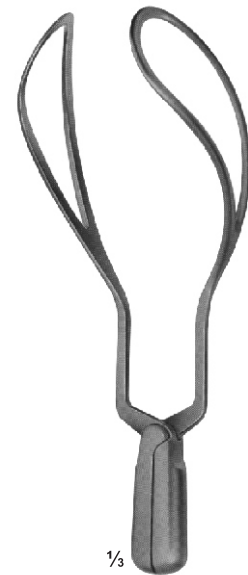

JJ-08-114
WRIGLEY
250 mm



BRAUN
Cranioclast
JJ-08-115
420 mm

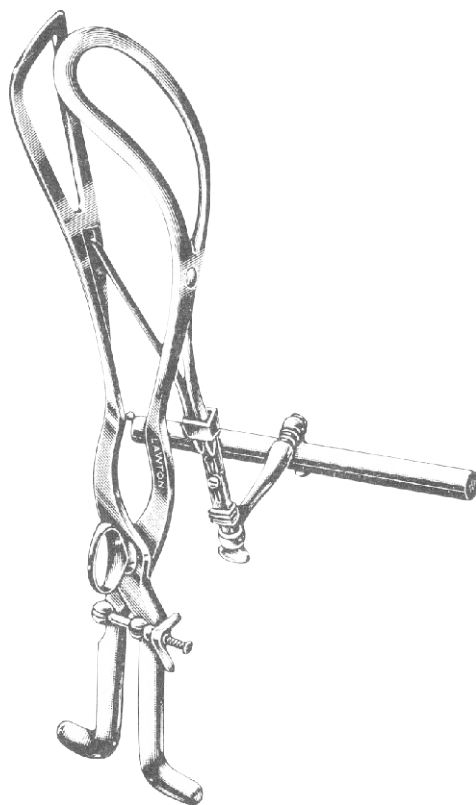

TARNIER
JJ-08-116
400 mm

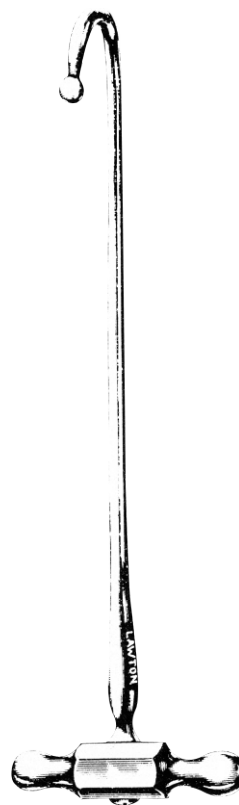

BRAUN
JJ-08-117
310 mm



SMELLIE
JJ-08-118
305 mm

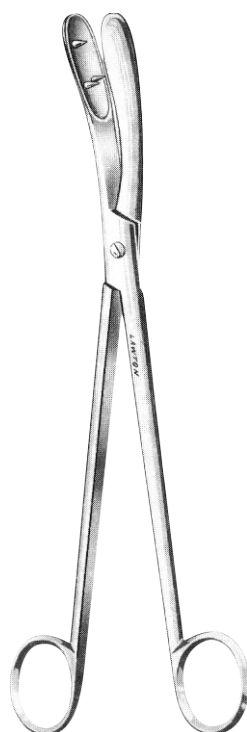

BOER
JJ-08-119
290 mm



SMELLIE
Perforator
JJ-08-120
270 mm



GREEN-ARMYTAGE
JJ-08-121
Caesarean section haemostatic
forceps, for edges of the transverse
incision in the lower segment
220 mm

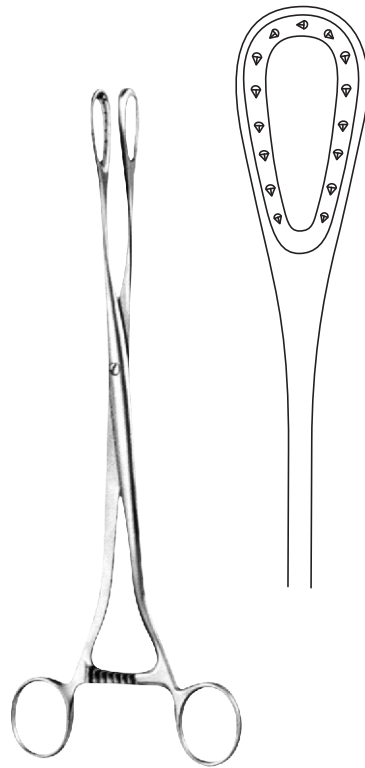

SANGER
JJ-08-122
275 mm

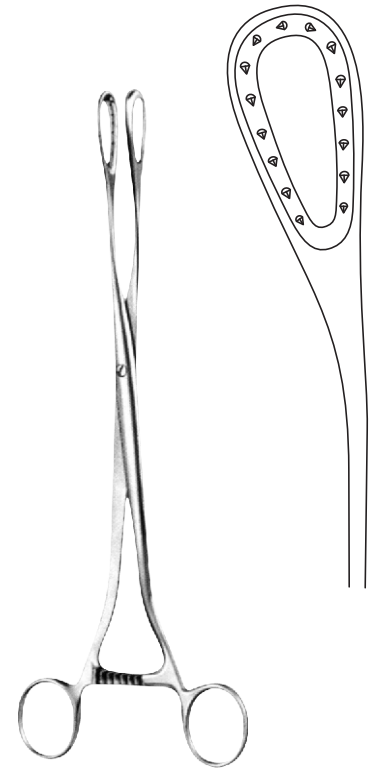

SANGER
JJ-08-123 - JJ-08-124
JJ-08-123 270 mm
JJ-08-124 290 mm



GAUSS
JJ-08-125
Scalpel Flap
forceps
260 mm



WILLETT
JJ-08-126
Scalpel Flap
forceps
185 mm



SELLHEIM
JJ-08-17
320 mm

PLACENTA SCOOPS, UMBILICAL CORD CLAMPS

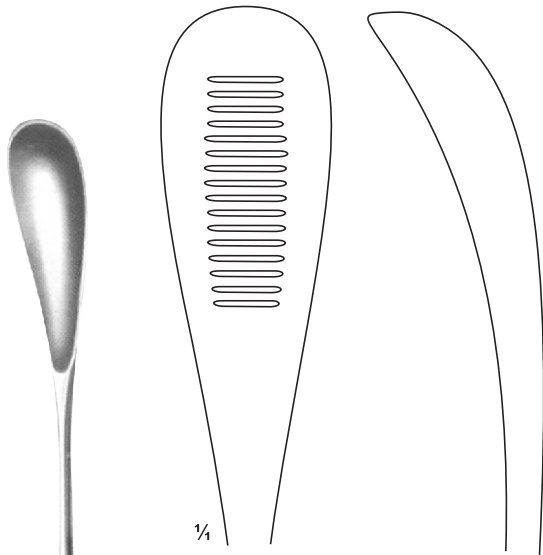

1/2

CUZZI
JJ-08-128 - JJ-08-130
 300 mm

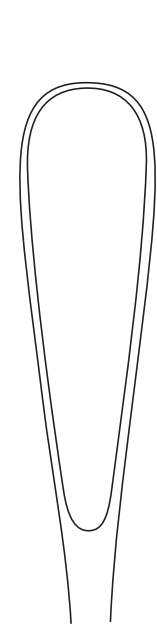

JJ-08-128
 17 mm

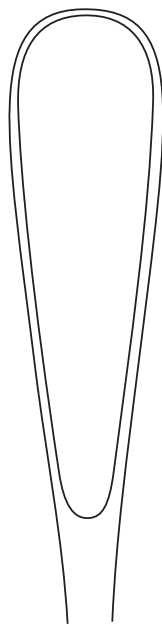

JJ-08-129
 20 mm

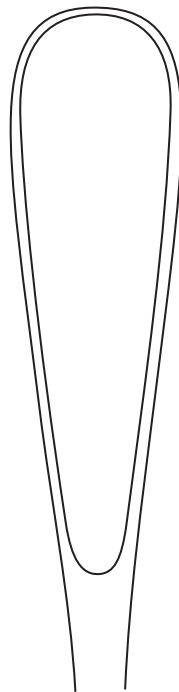

JJ-08-130
 23 mm

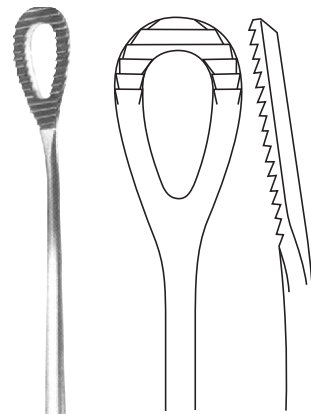

1/2

PESTALOZZA
JJ-08-131
 305 mm

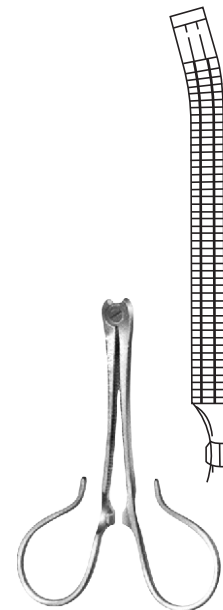

KANE
JJ-08-132
 85 mm

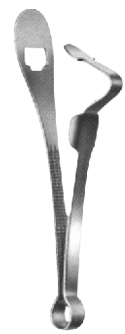

COLLIN
JJ-08-133
 85 mm



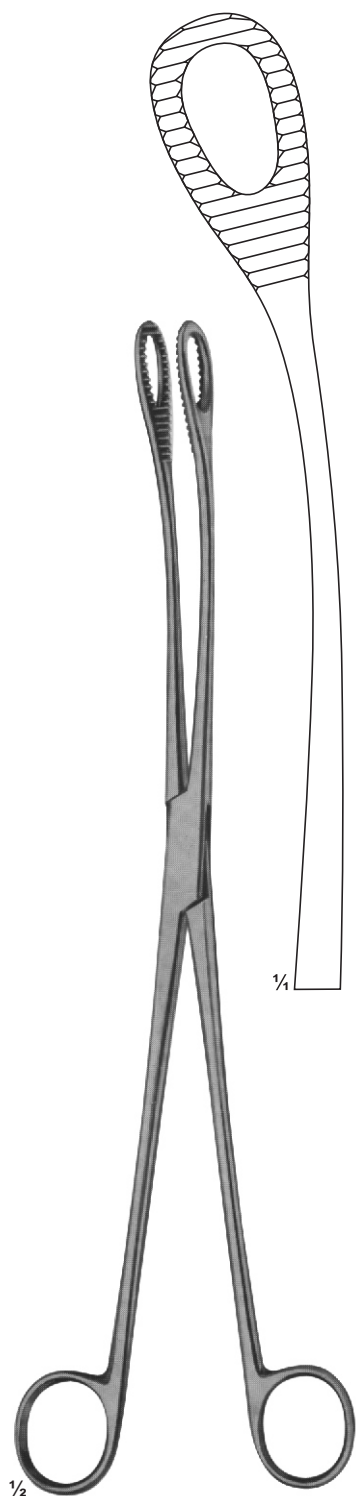

JJ-08-141
KELLY
320mm



JJ-08-142
SMELLIE
Perforator
270mm



JJ-08-143
BRAUN
Cranioclast
420mm



JJ-08-144
BOSE
165 mm

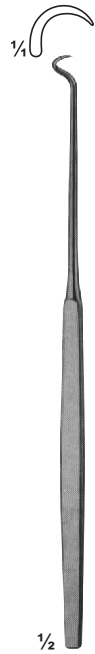

JJ-08-145
BOSE
165 mm



JJ-08-146 - JJ-08-148
180 mm



JJ-08-146
sharp



JJ-08-147
blunt

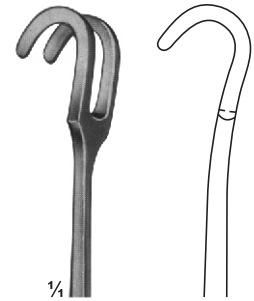

JJ-08-148
stumpf/blunt



JJ-08-149
FINSEN
50 mm

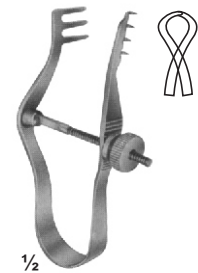

JJ-08-150
FINSEN
70 mm



JJ-08-151
TROUSSEAU
120 mm

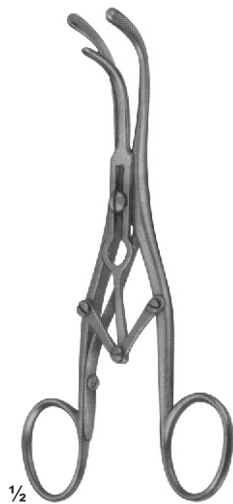

JJ-08-152
LABORDE
125 mm

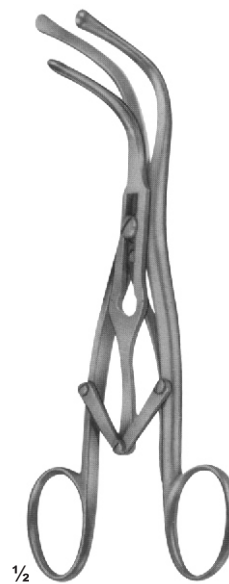

JJ-08-153
LABORDE
strong pattern
135 mm



JJ-08-154
Cleaning Brush
for tracheal tubes
285 mm

Page
157–185

▪ Haemostatic Forceps

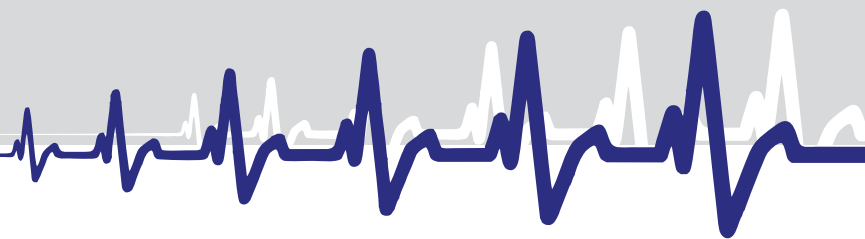

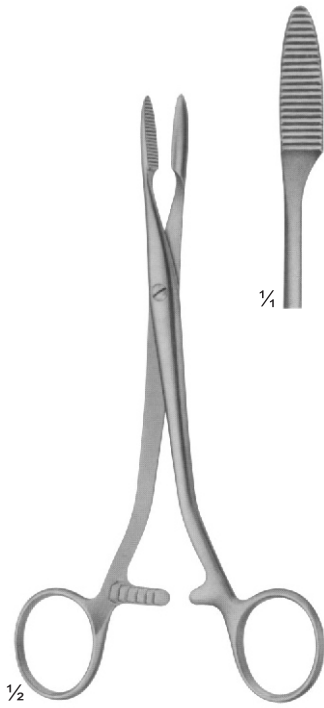

PEAN
JJ-09-101 160 mm
JJ-09-102 180 mm

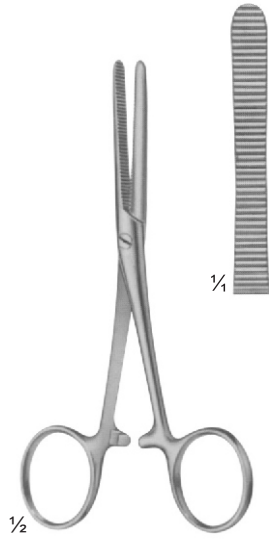

PEAN
JJ-09-103 125 mm

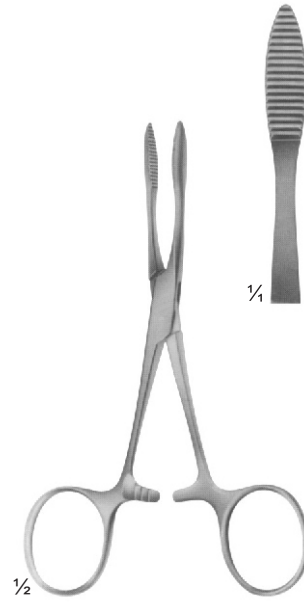

PEAN
JJ-09-104 125 mm
JJ-09-105 140 mm

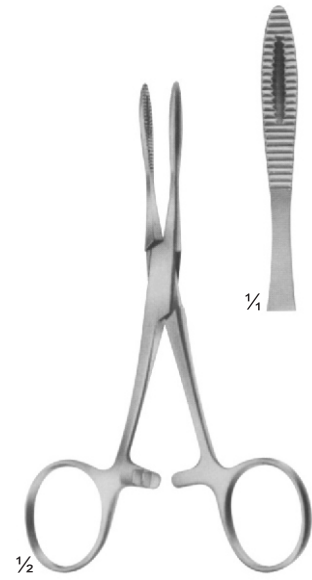

KRONLEIN
JJ-09-106 130 mm



SPENCER-WELLS
JJ-09-107 - JJ-09-113
JJ-09-107 130 mm
JJ-09-108 140 mm
JJ-09-109 150 mm
JJ-09-110 180 mm
JJ-09-111 200 mm
JJ-09-112 250 mm
JJ-09-113 300 mm

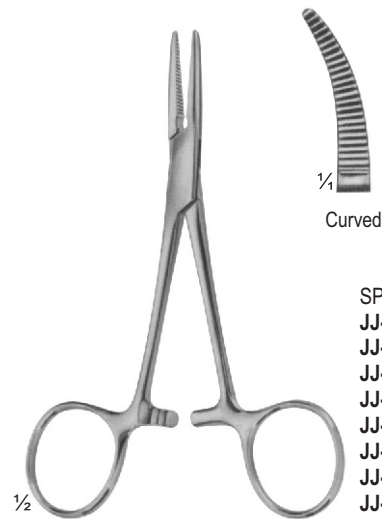

SPENCER-WELLS
JJ-09-114 - JJ-09-120
JJ-09-114 130 mm
JJ-09-115 140 mm
JJ-09-116 150 mm
JJ-09-117 180 mm
JJ-09-118 200 mm
JJ-09-119 250 mm
JJ-09-120 300 mm

DELICATE HAEMOSTATIC FORCEPS

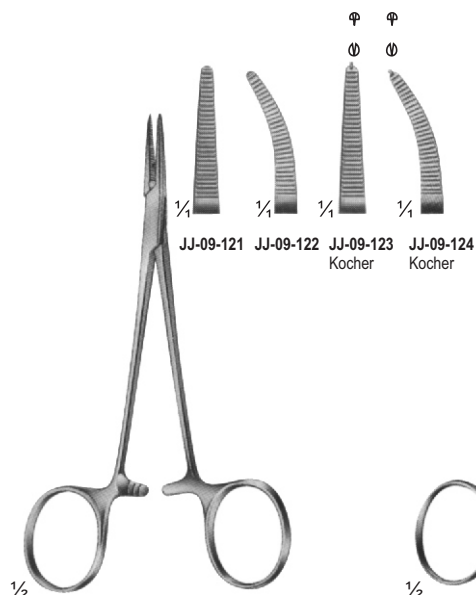

JJ-09-121 - JJ-09-124
HALSTED-MOSQUITO
125 mm

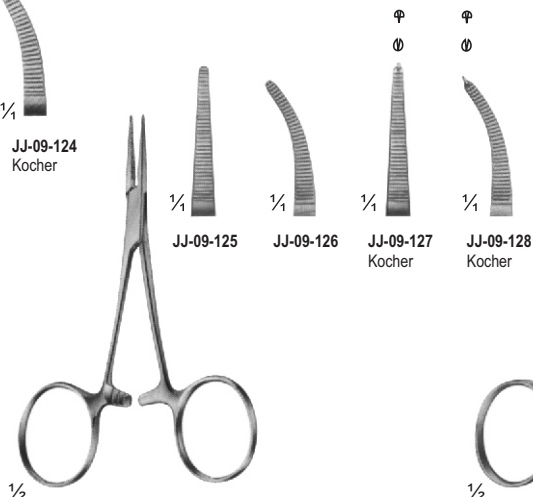

JJ-09-125 - JJ-09-128
BABY-MOSQUITO
(HARTMANN)
100 mm

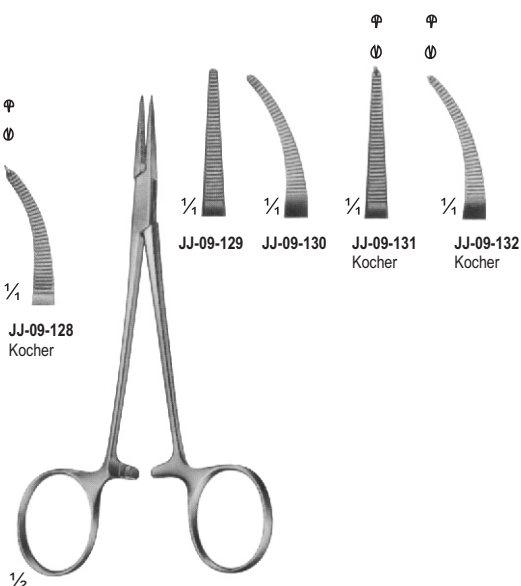

JJ-09-129 - JJ-09-132
MICRO-HALSTED
125 mm

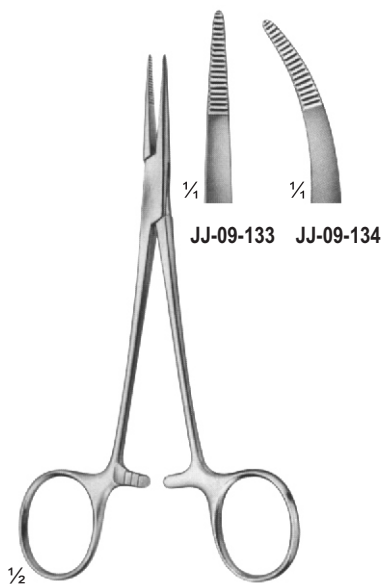

JJ-09-133 - JJ-09-134
PROVIDENCE-HOSPITAL
140 mm



JJ-09-135 - JJ-09-136
KELLY
140 mm

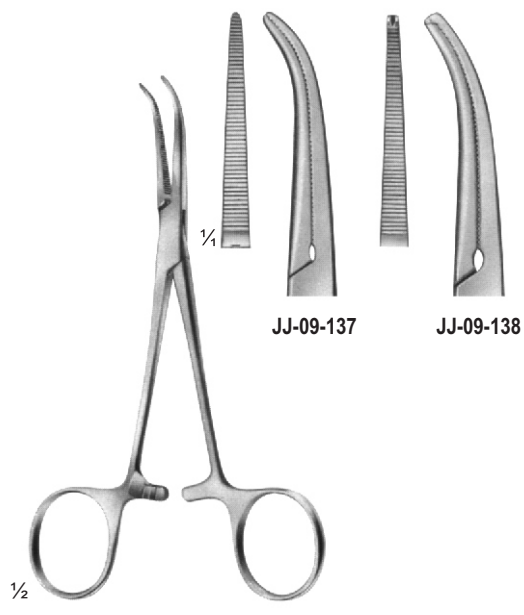

JJ-09-137 - JJ-09-138
DANDY
Curved sideways
140 mm

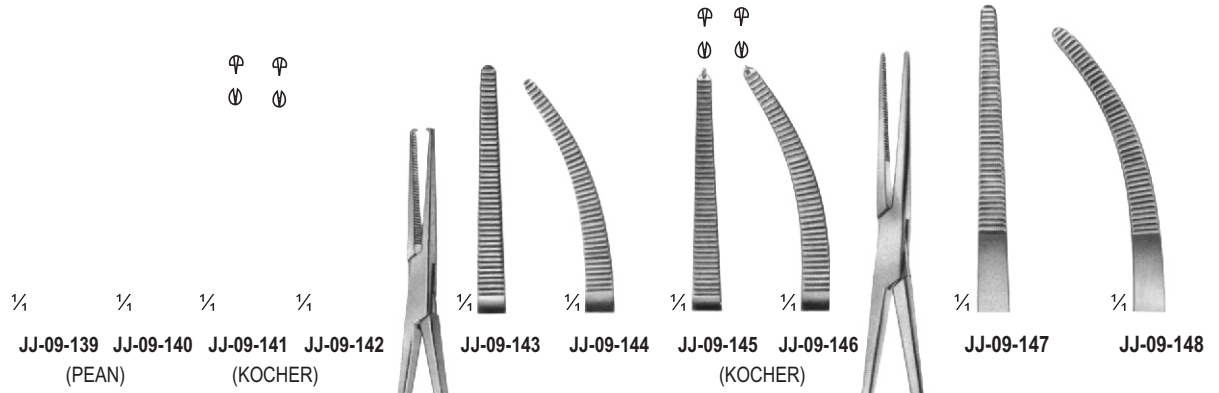

1/2
JJ-09-139 - JJ-09-142
BABY-CRILE
140 mm

1/2
JJ-09-143 - JJ-09-146
CRILE
140 mm

1/2
JJ-09-147 - JJ-09-148
RANKIN
160 mm

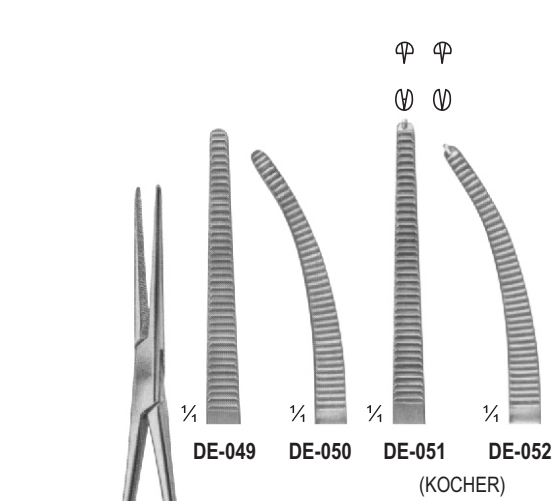

1/2
DE-049 - 052
CRILE
160 mm

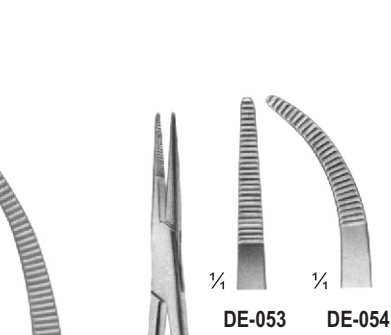

1/2
DE-053 - 054
ADSON
185 mm

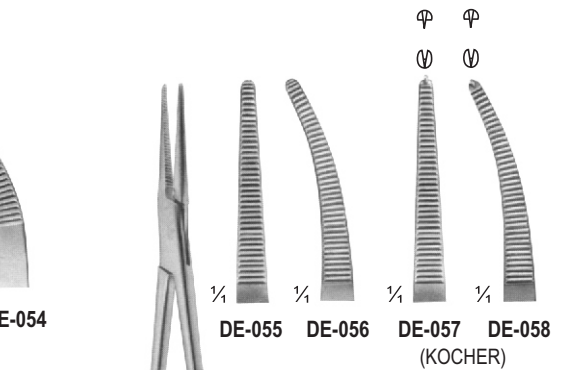

1/2
DE-055 - 058
HALSTED
185 mm

DELICATE HAEMOSTATIC FORCEPS



$\frac{1}{2}$
JJ-09-159 - JJ-09-163
 HEISS
 200 mm



$\frac{1}{4}$
JJ-09-159



$\frac{1}{4}$
JJ-09-160



$\frac{1}{4}$
JJ-09-161



$\frac{1}{4}$
JJ-09-162



$\frac{1}{4}$
JJ-09-163

(Kocher)



$\frac{1}{2}$
JJ-09-164 - JJ-09-165
 HALSTED
 215 mm

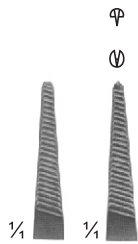

$\frac{1}{4}$
JJ-09-164



$\frac{1}{4}$
JJ-09-165
 (Kocher)

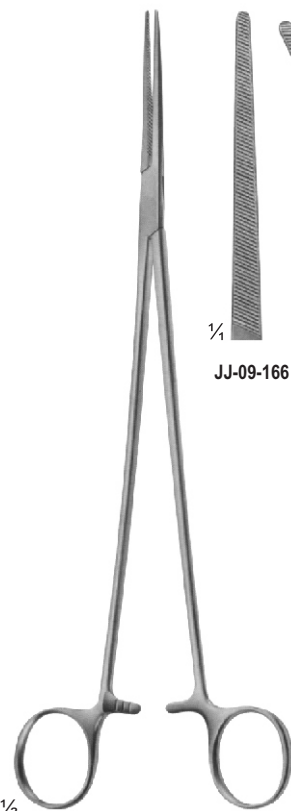

$\frac{1}{2}$
JJ-09-166 - JJ-09-169
 BENGOLEA
 245 mm

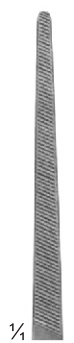

$\frac{1}{4}$
JJ-09-166



$\frac{1}{4}$
JJ-09-167



$\frac{1}{4}$
JJ-09-168



$\frac{1}{4}$
JJ-09-169

(Kocher)

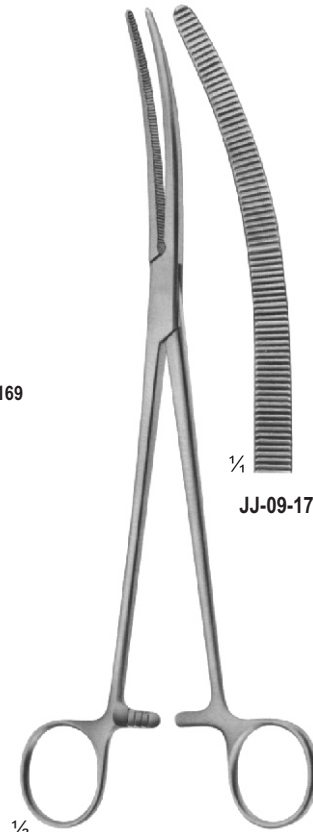

$\frac{1}{2}$
JJ-09-170
 CRAFOORD
 245 mm



$\frac{1}{4}$
JJ-09-170

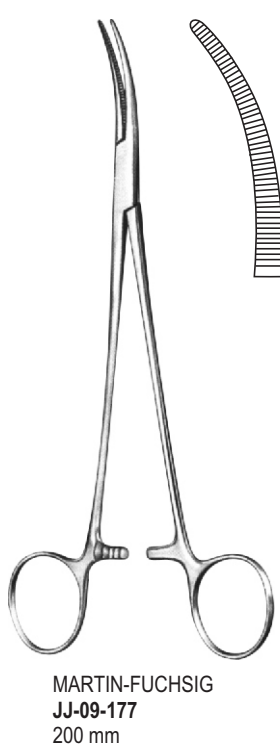
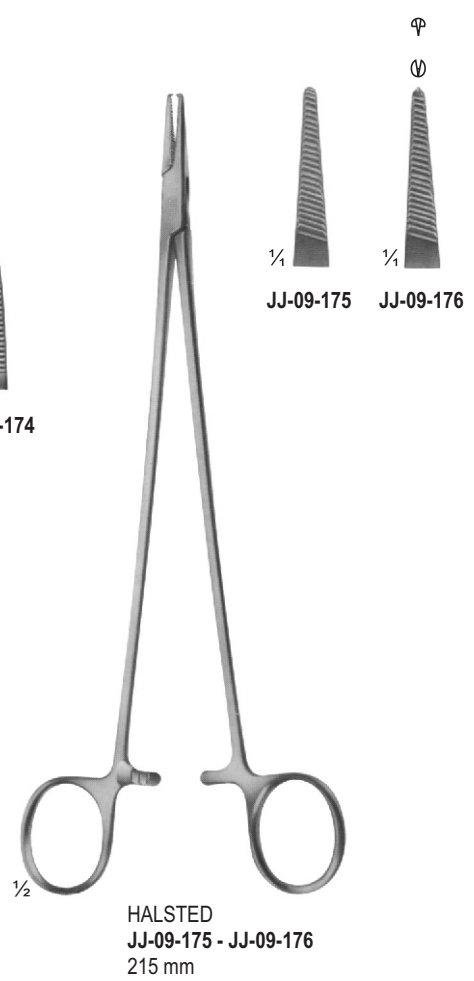
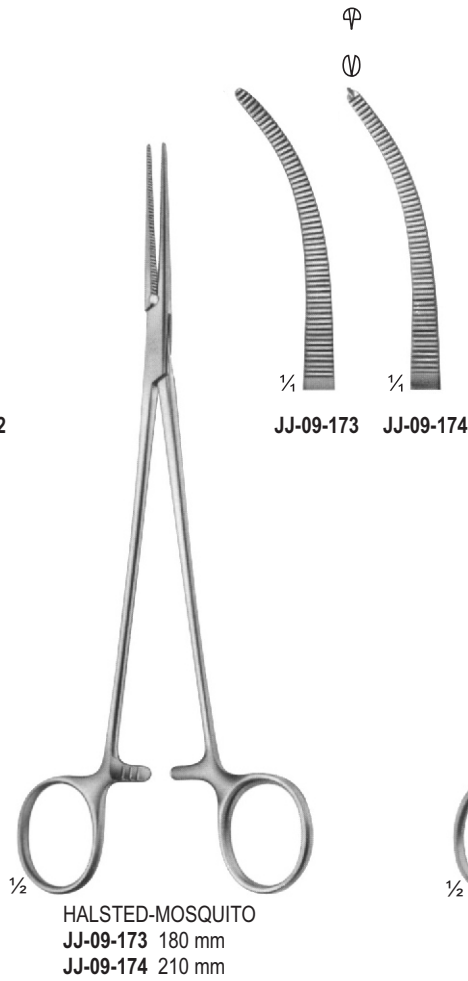
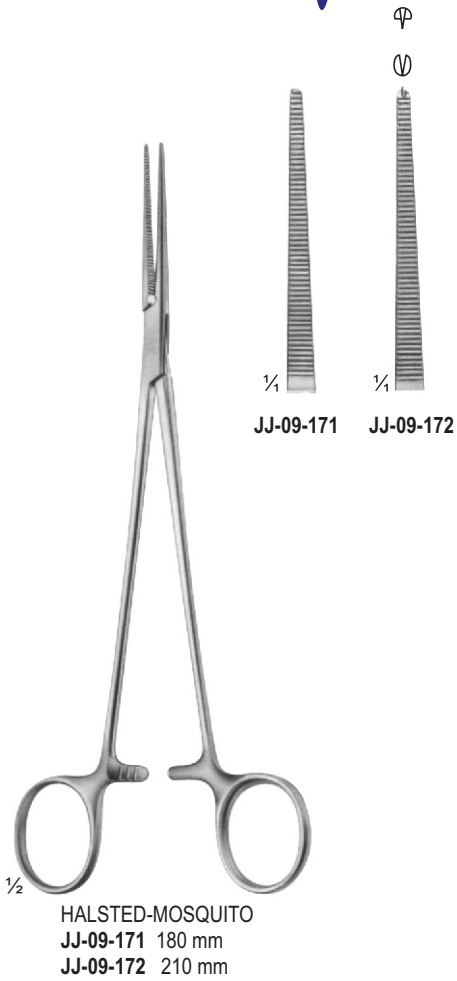

HAEMOSTATIC FORCEPS

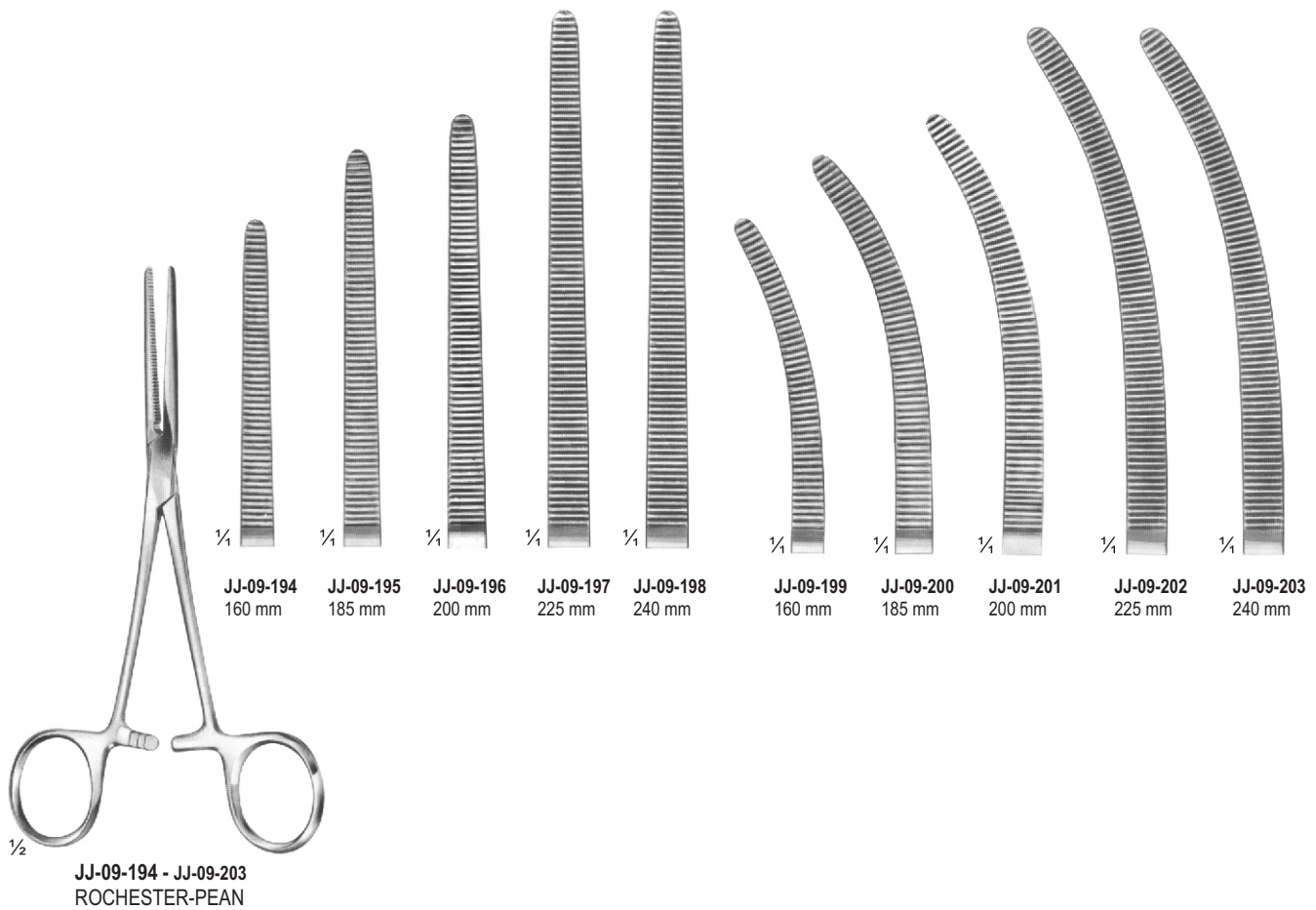
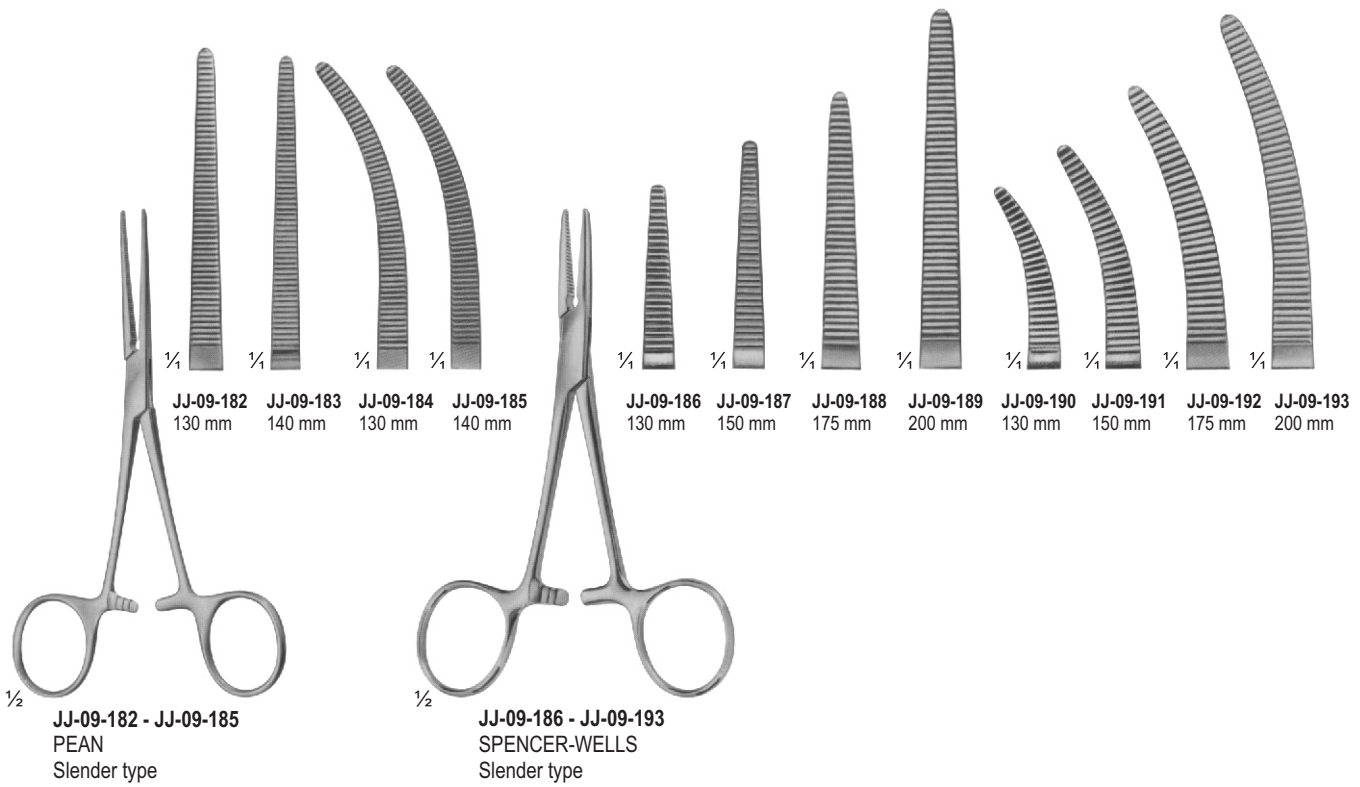

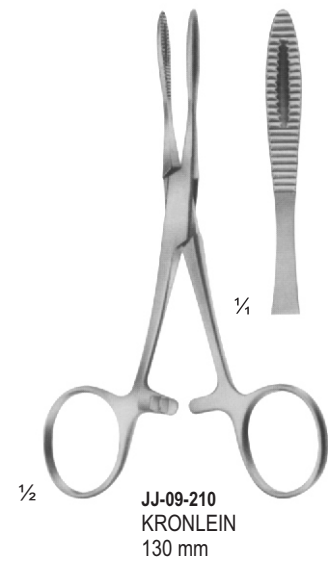
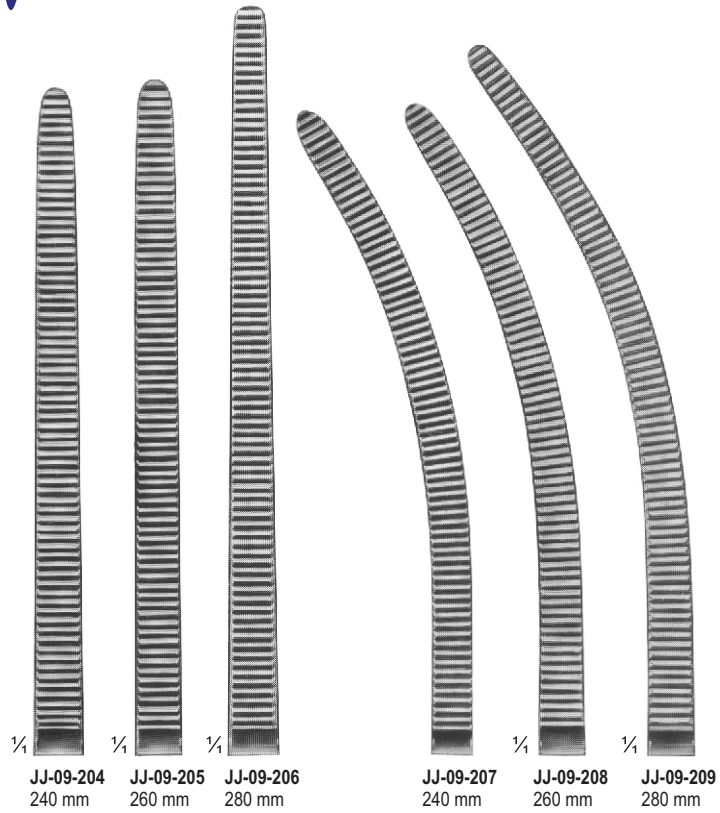

1/2 **JJ-09-204 - JJ-09-209**
PEAN

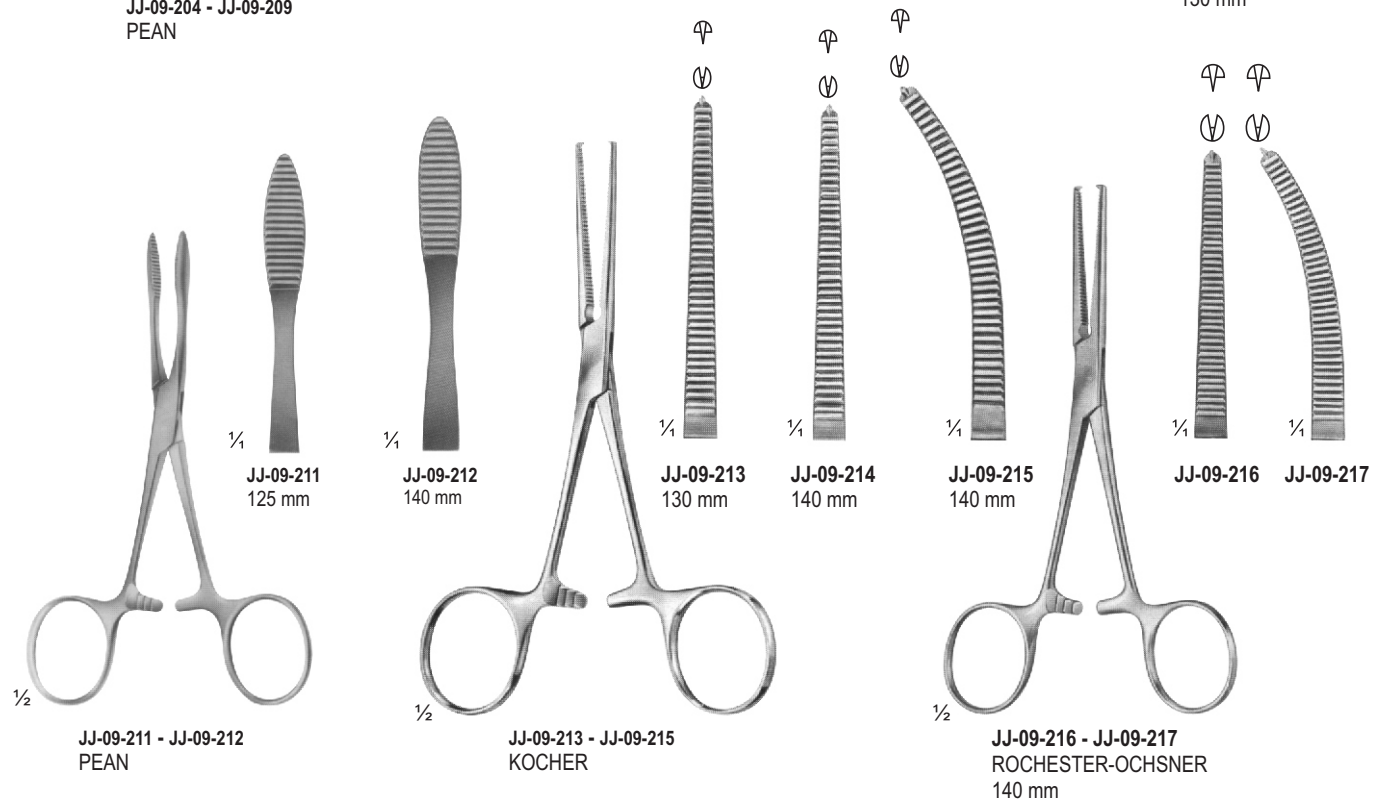

HAEMOSTATIC FORCEPS



1/2

JJ-09-218 - JJ-09-223
KOCHER-OCHSNER (STR)

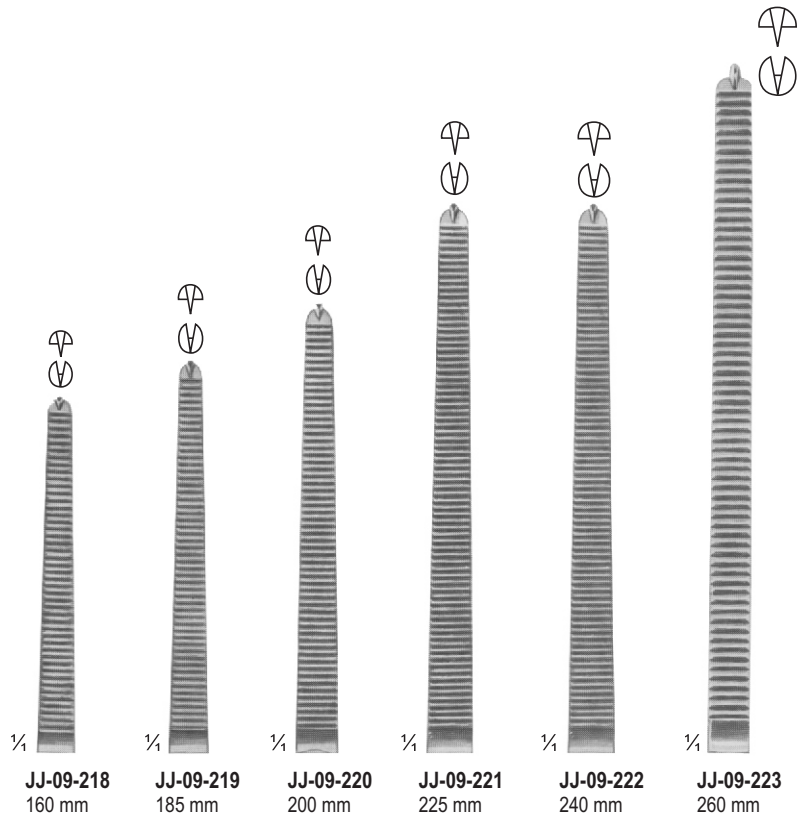

1/2

JJ-09-224 - JJ-09-229
KOCHER-OCHSNER (CVD)

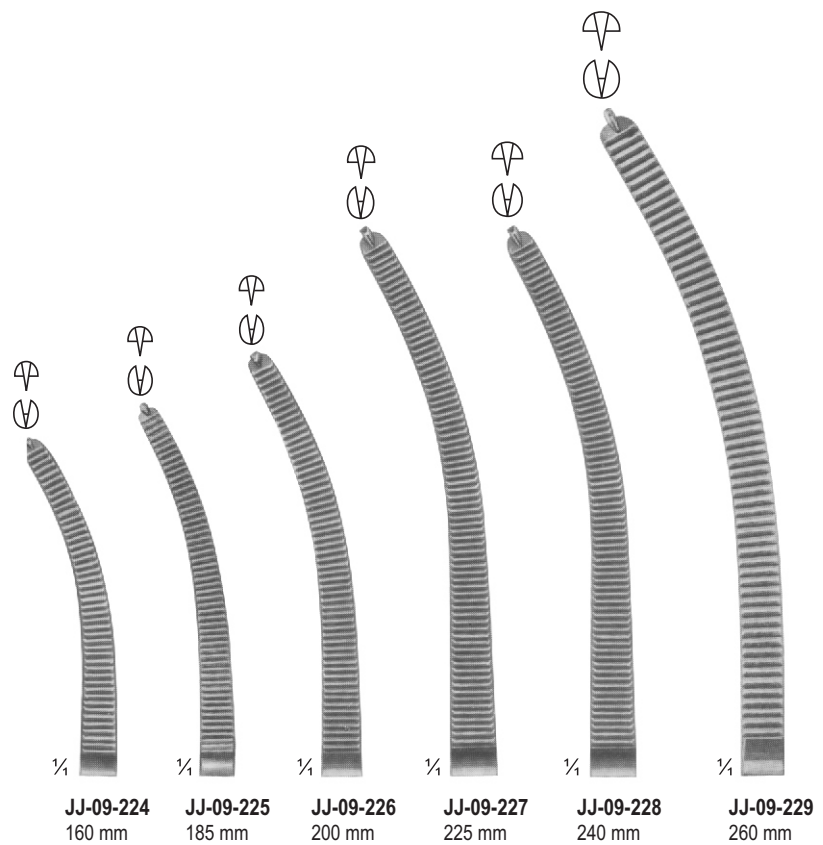

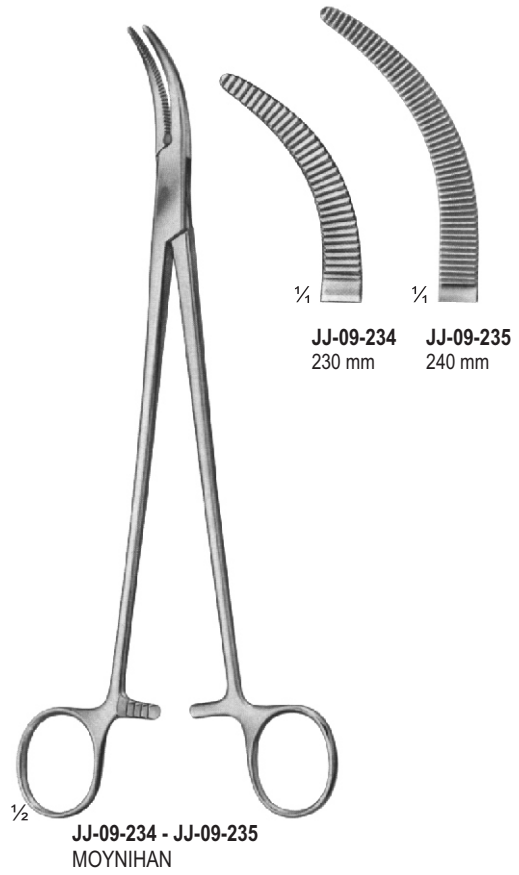

1/4 1/4 1/4 1/4

JJ-09-230 **JJ-09-231** **JJ-09-232** **JJ-09-233**
160 mm 200 mm 160 mm 200 mm

1/2 **JJ-09-230 - JJ-09-233**
ROCHESTER-CARMALT

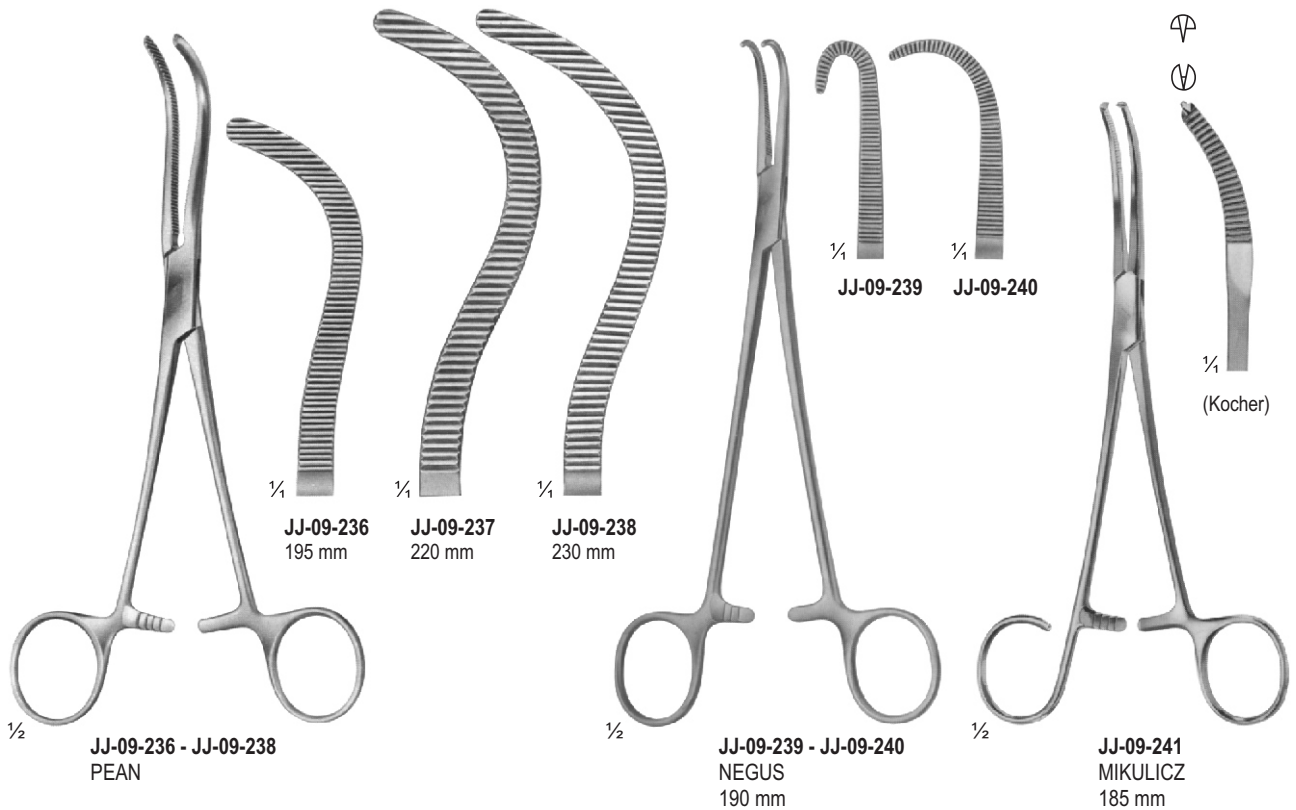

DISSECTING- AND LIGATURE FORCEPS

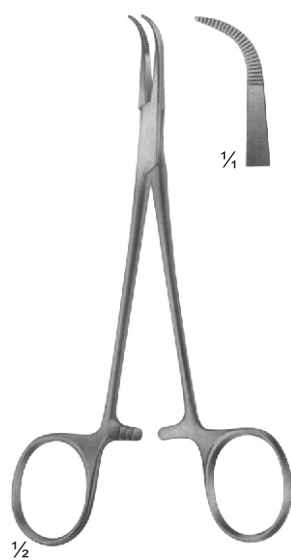

JJ-09-242
MICRO-ADSON
140 mm

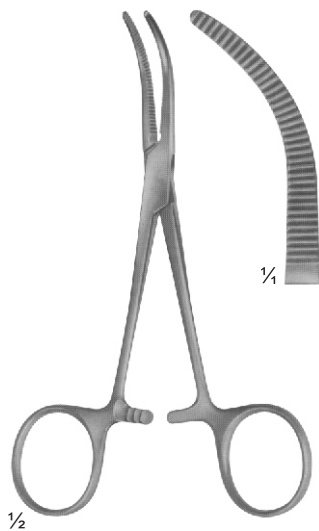

JJ-09-243
BABY-OVERHOLT
135 mm

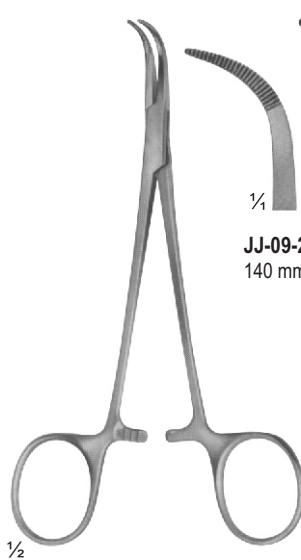

JJ-09-244 - JJ-09-245
BABY-MIXTER

JJ-09-244
140 mm

JJ-09-245
180 mm

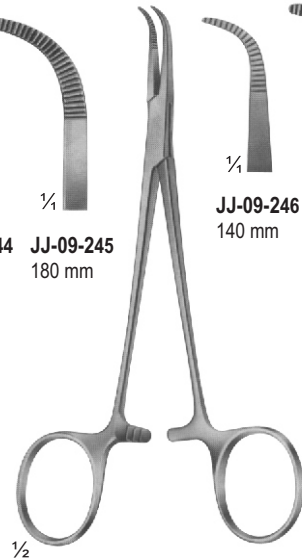

JJ-09-246 - JJ-09-247
BABY-ADSON

JJ-09-246
140 mm

JJ-09-247
180 mm

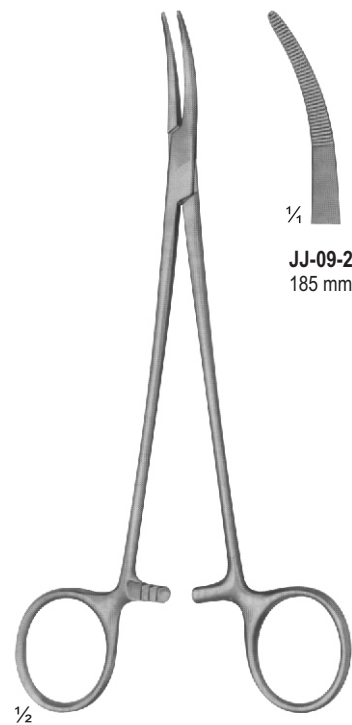

JJ-09-248
NISSEN



JJ-09-248
185 mm



JJ-09-249 - JJ-09-250
YASARGIL
195 mm

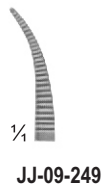

JJ-09-249

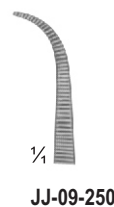

JJ-09-250



JJ-09-251
OVERHOLT-MIXTER

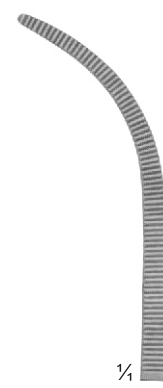

JJ-09-251
205 mm

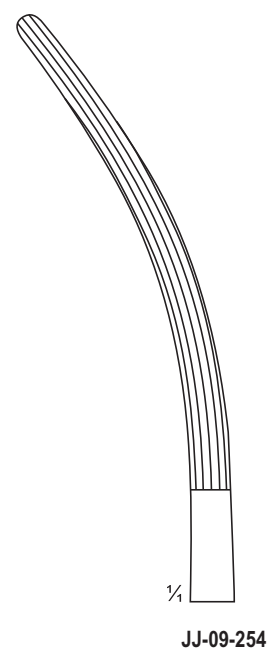
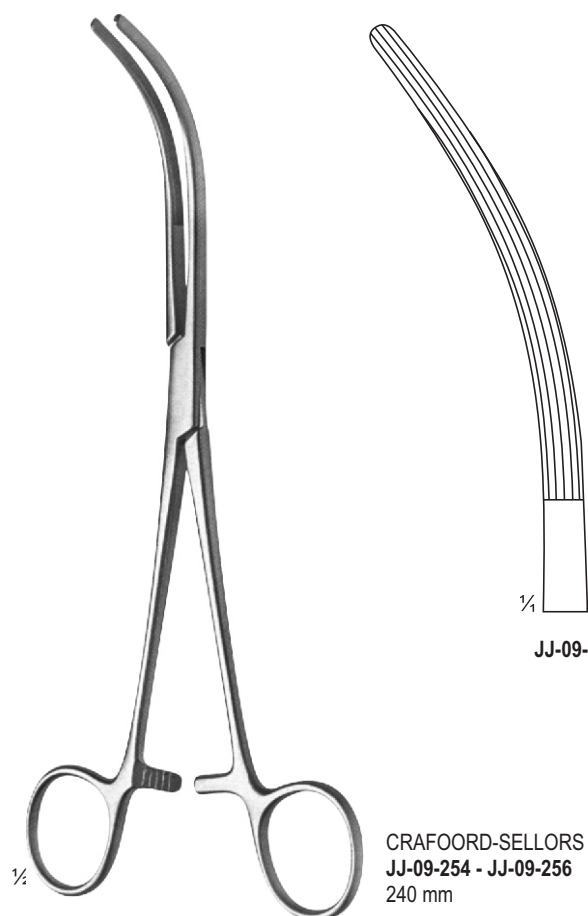
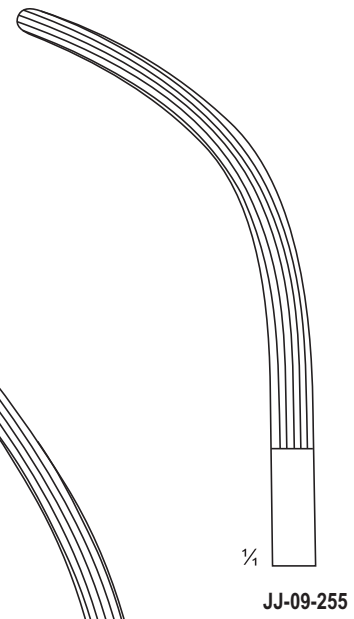
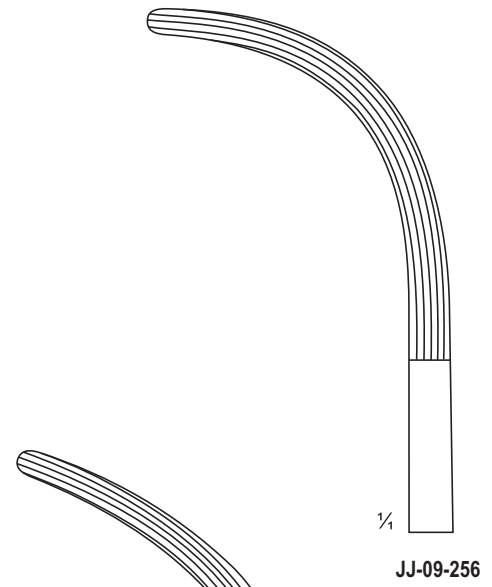
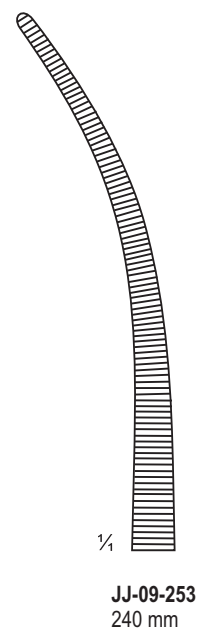
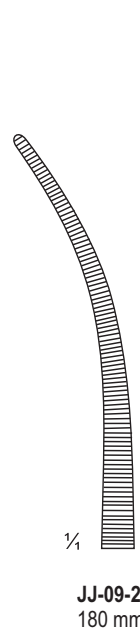

HAEMOSTATIC, SPECIAL PATTERN AND TONSIL FORCEPS

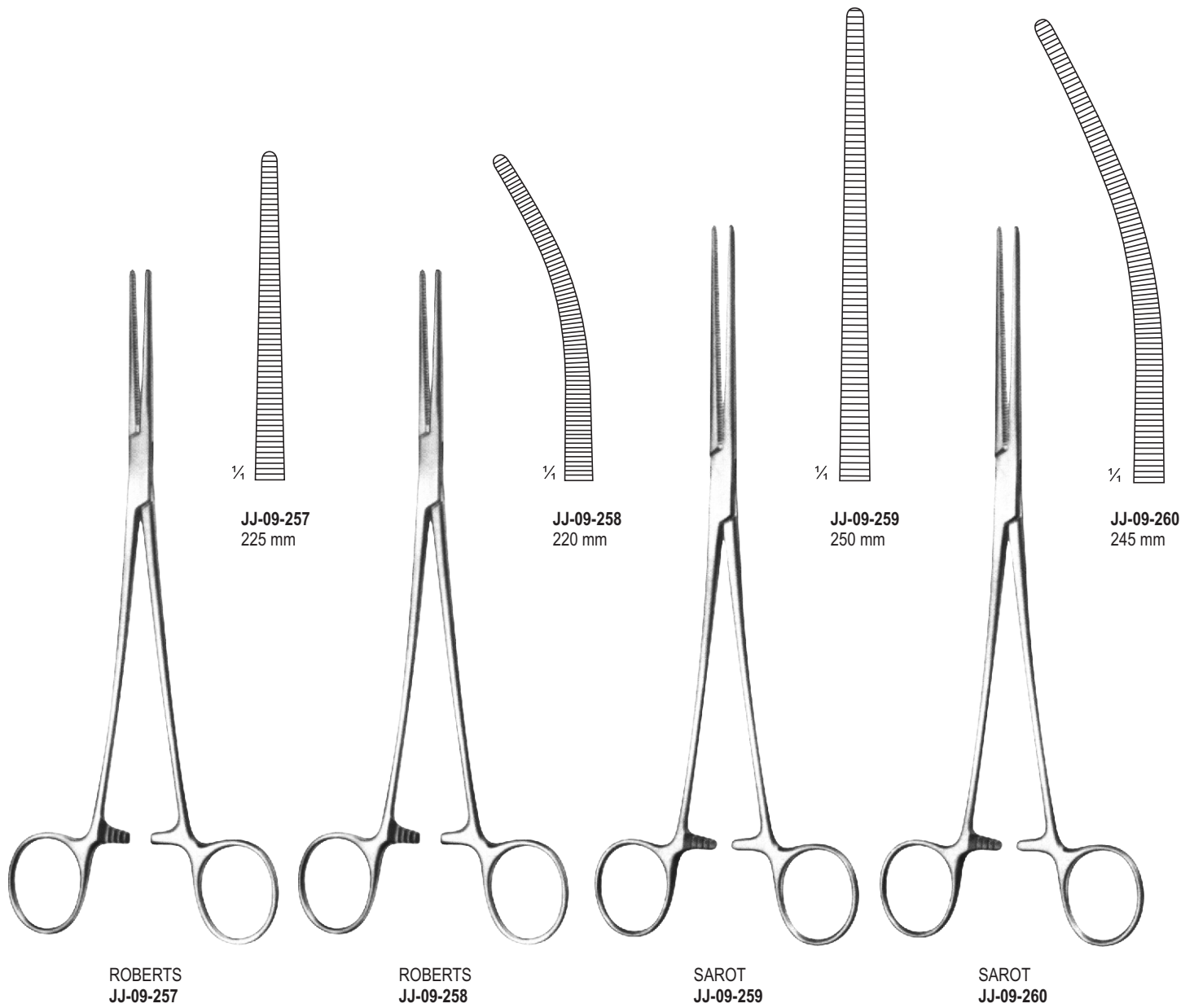



JJ-09-261

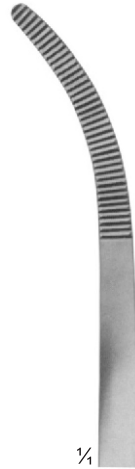

JJ-09-262



JJ-09-263

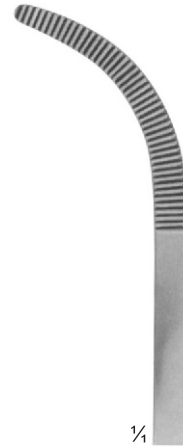

JJ-09-264



JJ-09-265

RUMEL
JJ-09-261 - JJ-09-265
240 mm

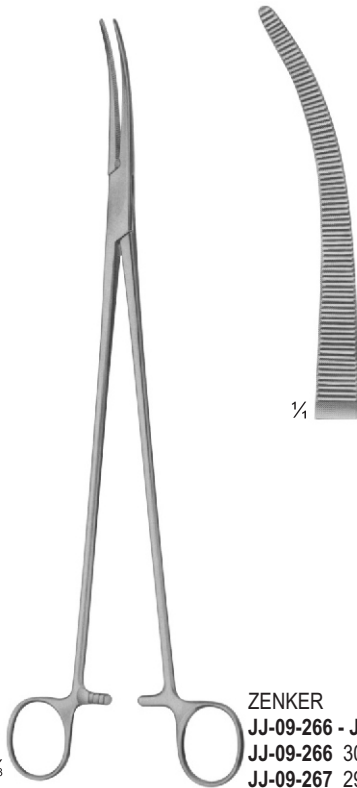

ZENKER
JJ-09-266 - JJ-09-267
JJ-09-266 300 mm
JJ-09-267 290 mm

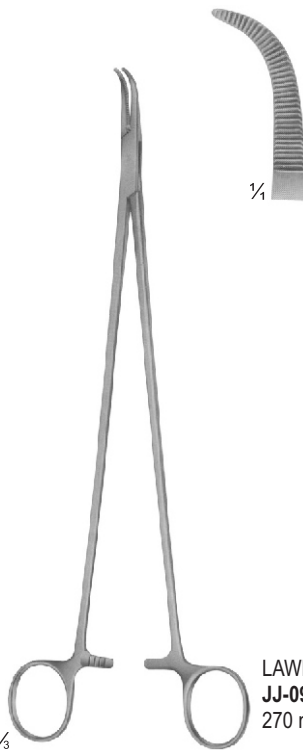

LAWRENCE
JJ-09-268
270 mm

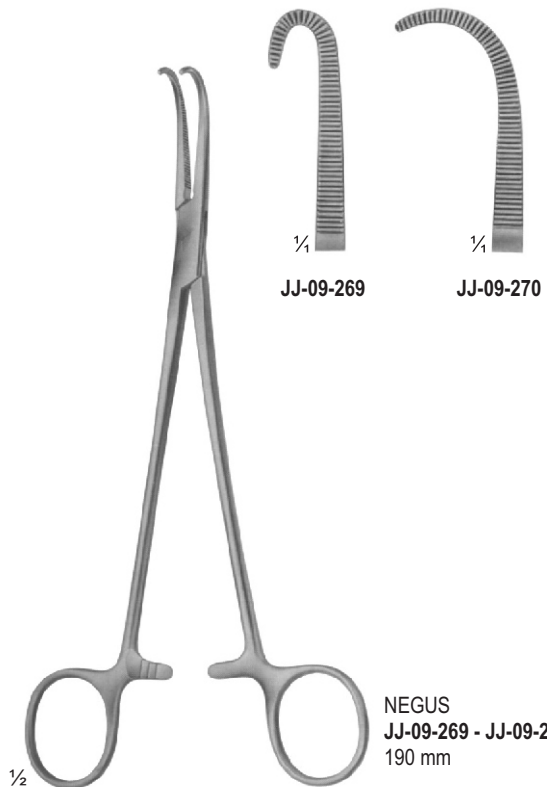

NEGUS
JJ-09-269 - JJ-09-270
JJ-09-269 190 mm
JJ-09-270 190 mm

DISSECTING- AND LIGATURE FORCEPS

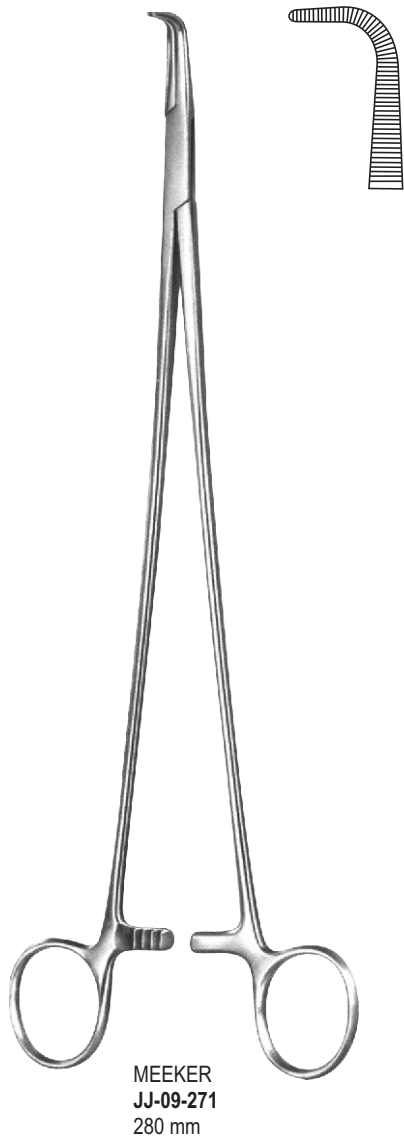

Fig. 1
JJ-09-272
190 mm



Fig. 1
JJ-09-273
225 mm

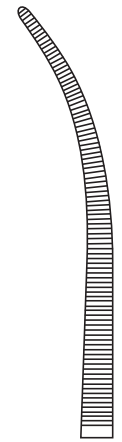

Fig. 1
JJ-09-274
240 mm



Fig. 2
JJ-09-275
190 mm



Fig. 2
JJ-09-276
220 mm

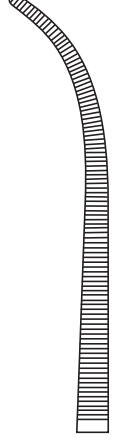

Fig. 2
JJ-09-277
235 mm



Fig. 3
JJ-09-278
185 mm



Fig. 3
JJ-09-279
215 mm

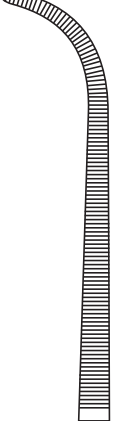

Fig. 3
JJ-09-280
235 mm



$\frac{1}{2}$
JJ-09-281 - JJ-09-292
OVERHOLT-GEISSENDOERFER

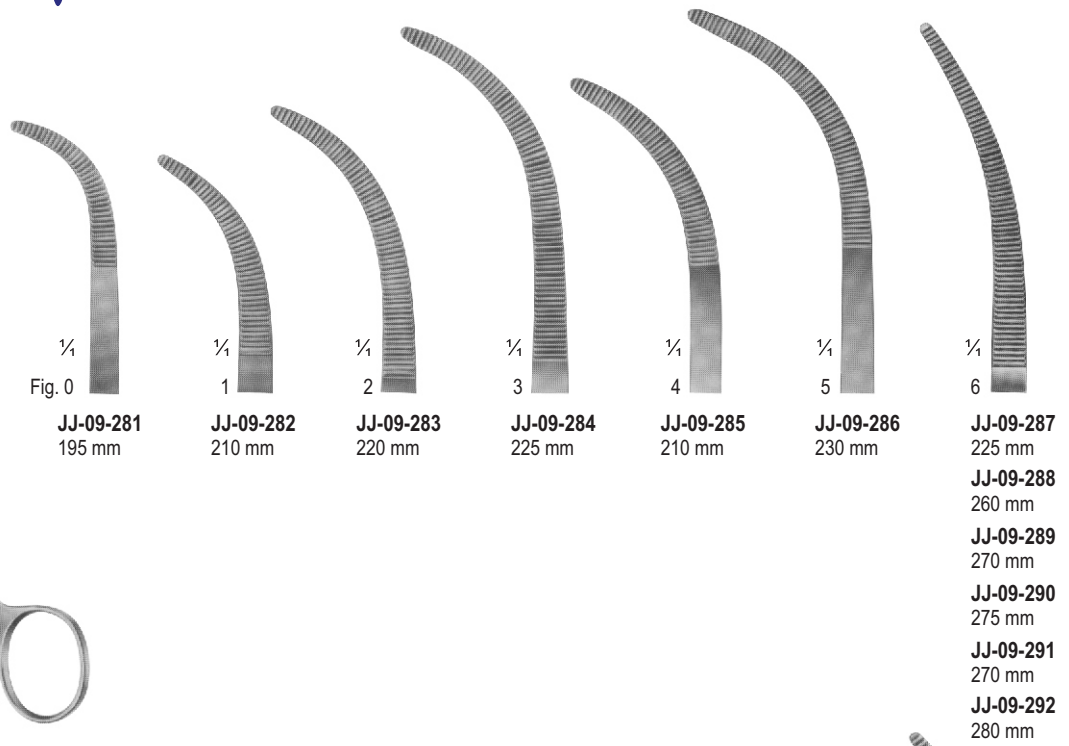
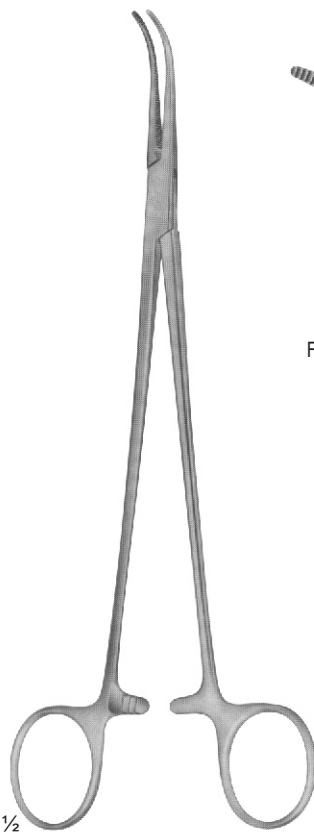

Fig. 0	1	2	3	4	5	6
$\frac{1}{4}$	$\frac{1}{4}$	$\frac{1}{4}$	$\frac{1}{4}$	$\frac{1}{4}$	$\frac{1}{4}$	$\frac{1}{4}$
JJ-09-281 195 mm	JJ-09-282 210 mm	JJ-09-283 220 mm	JJ-09-284 225 mm	JJ-09-285 210 mm	JJ-09-286 230 mm	JJ-09-287 225 mm
						JJ-09-288 260 mm
						JJ-09-289 270 mm
						JJ-09-290 275 mm
						JJ-09-291 270 mm
						JJ-09-292 280 mm



$\frac{1}{2}$
JJ-09-293 - JJ-09-300
OVERHOLT
fine pattern

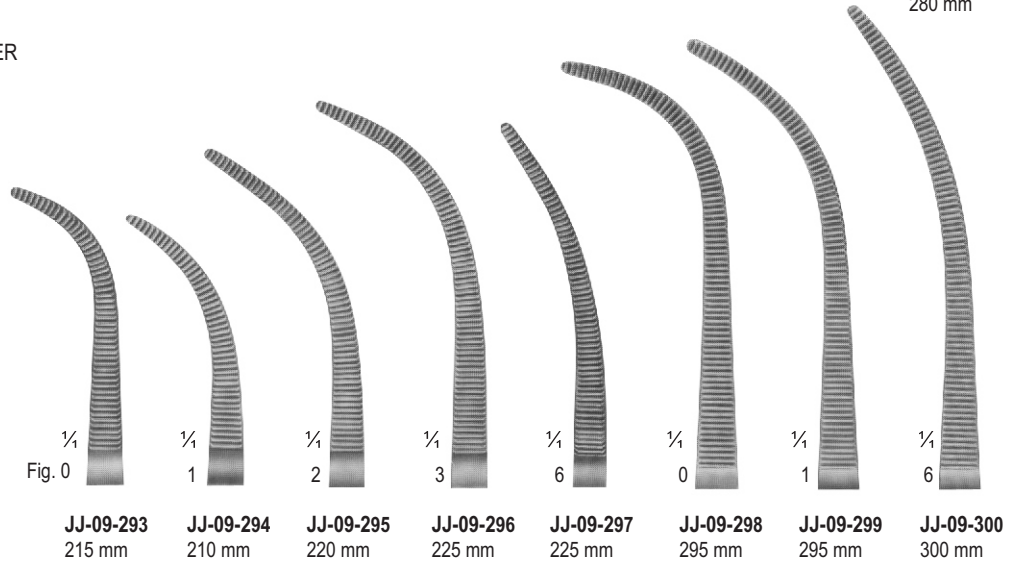
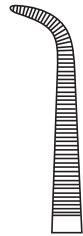

Fig. 0	1	2	3	6	0	1	6
$\frac{1}{4}$	$\frac{1}{4}$	$\frac{1}{4}$	$\frac{1}{4}$	$\frac{1}{4}$	$\frac{1}{4}$	$\frac{1}{4}$	$\frac{1}{4}$
JJ-09-293 215 mm	JJ-09-294 210 mm	JJ-09-295 220 mm	JJ-09-296 225 mm	JJ-09-297 225 mm	JJ-09-298 295 mm	JJ-09-299 295 mm	JJ-09-300 300 mm

HAEMOSTATIC FORCEPS



MINI-GEMINI
JJ-09-301 - JJ-09-304



JJ-09-301
180 mm

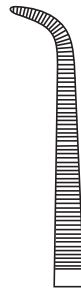

JJ-09-302
230 mm

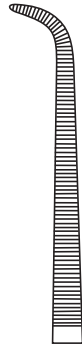

JJ-09-303
250 mm

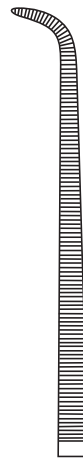

JJ-09-304
280 mm

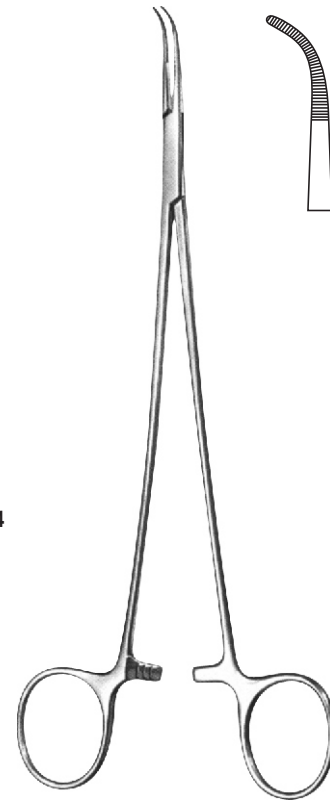

OVERHOLT-MINI
JJ-09-305
200 mm



GEMINI
JJ-09-306 - JJ-09-312



JJ-09-306
130 mm

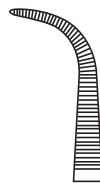

JJ-09-307
160 mm



JJ-09-308
180 mm

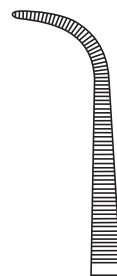

JJ-09-309
210 mm

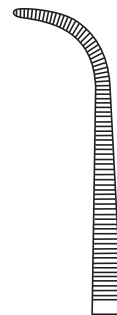

JJ-09-310
230 mm

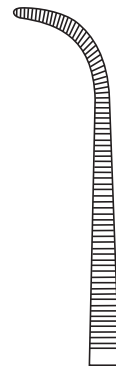

JJ-09-311
250 mm

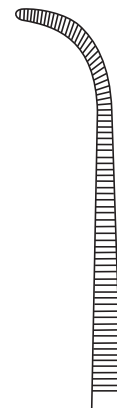

JJ-09-312
280 mm

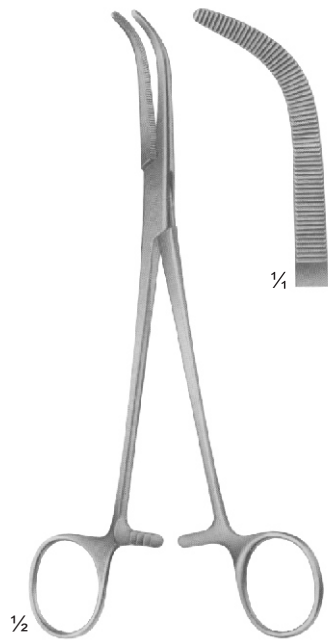

JJ-09-313
MIXTER-O'SHAUGHNESSY
190 mm

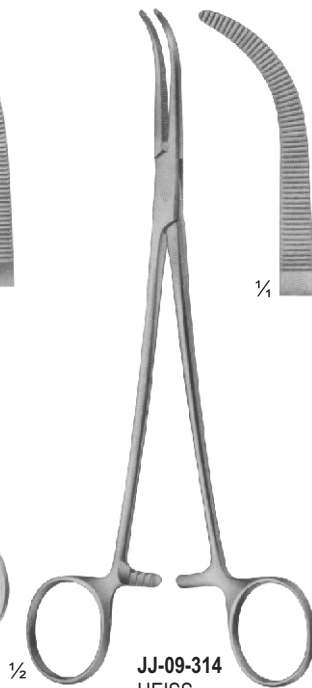

JJ-09-314
HEISS
195 mm

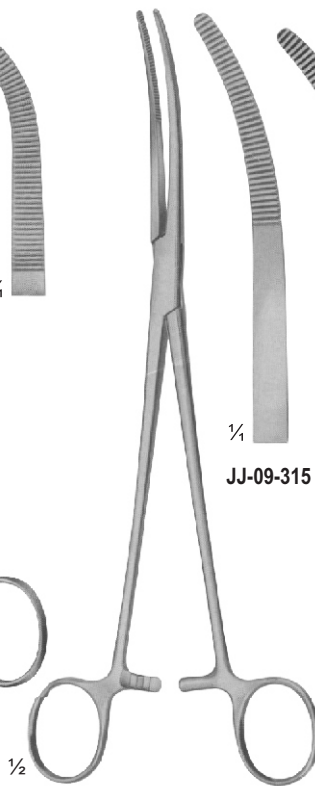

JJ-09-315 - JJ-09-319
RUMEL
240 mm

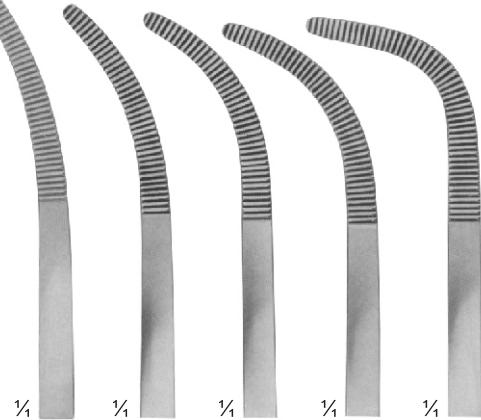

JJ-09-315 JJ-09-316 JJ-09-317 JJ-09-318 JJ-09-319

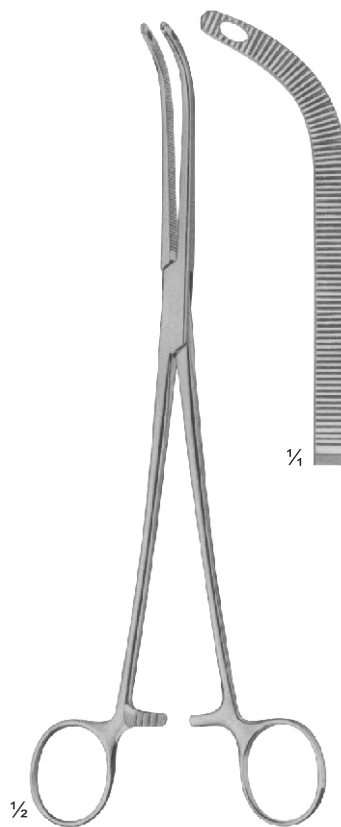

JJ-09-320
FINOCHIETTO
245 mm

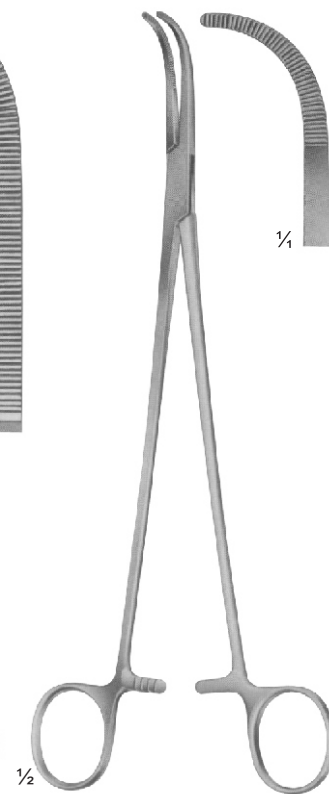

JJ-09-321
MIXTER
230 mm



JJ-09-322
LAWRENCE
270 mm

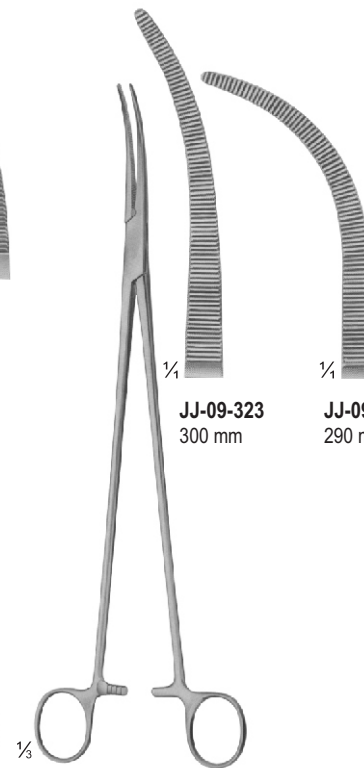

JJ-09-323
300 mm

JJ-09-324
290 mm

JJ-09-323 - JJ-09-324
ZENKER

DISSECTING- AND LIGATURE FORCEPS

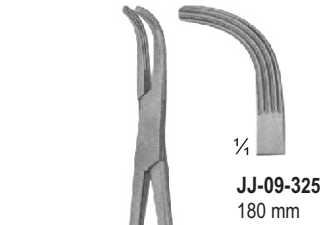

$\frac{1}{2}$
JJ-09-325
LOWER



$\frac{1}{2}$
JJ-09-326 - JJ-09-327
LAHEY (SWEET)

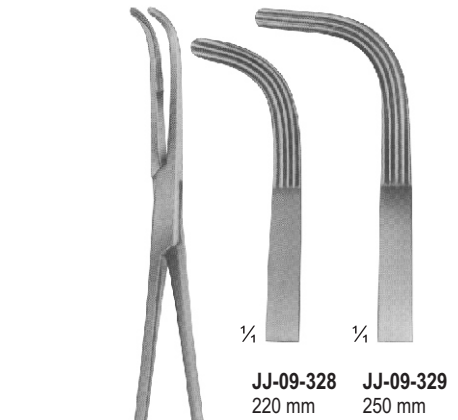

$\frac{1}{2}$
JJ-09-328 - JJ-09-329
MIXTER

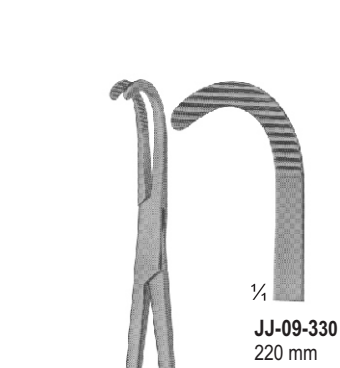

$\frac{1}{2}$
JJ-09-330
DESJARDINS

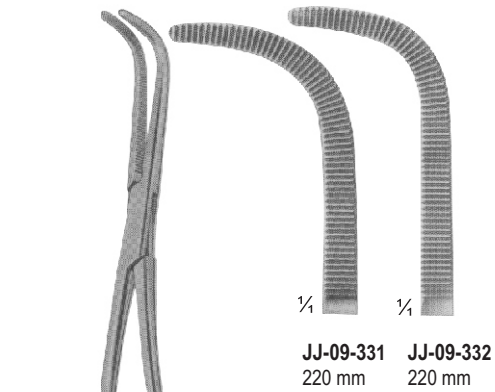

$\frac{1}{2}$
JJ-09-331 - JJ-09-332
GRAY

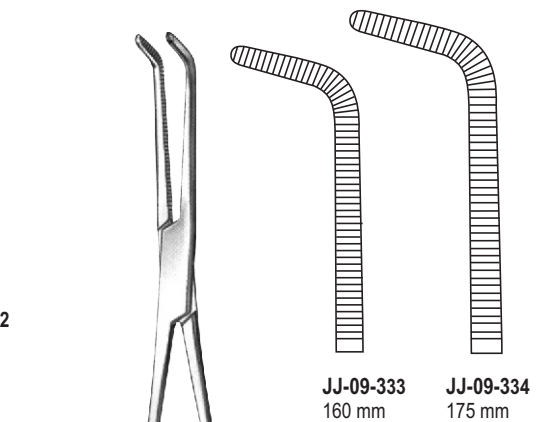

MIXTER
JJ-09-333 - JJ-09-334

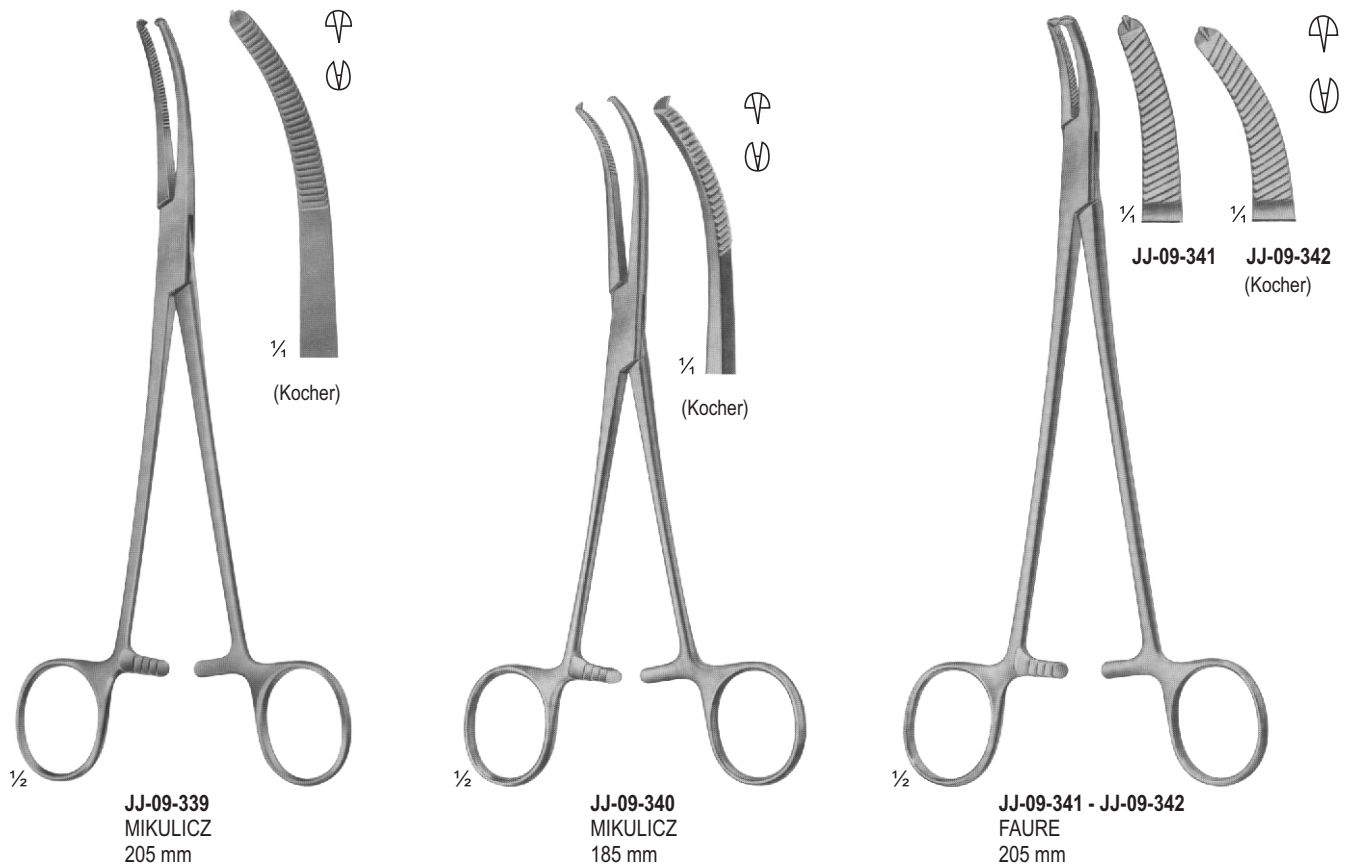
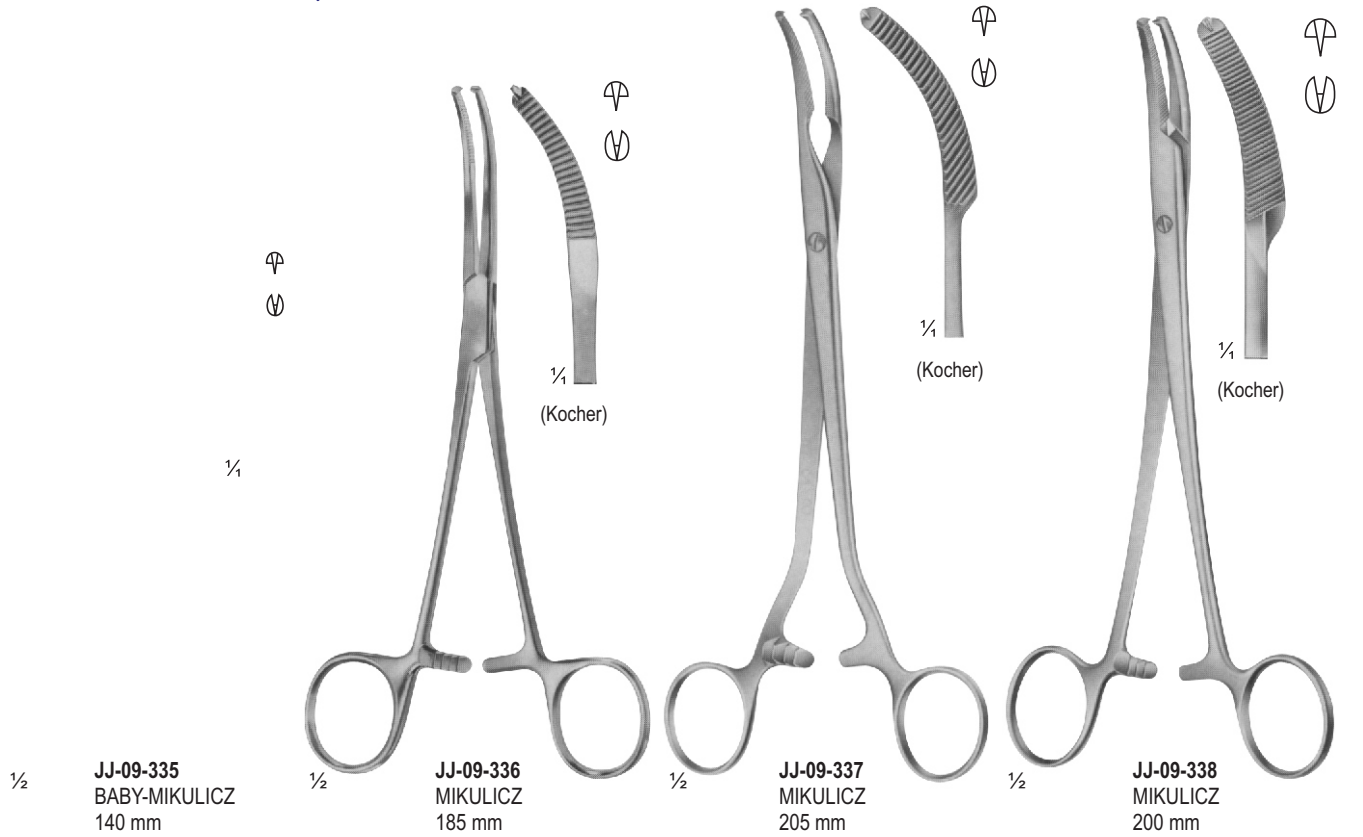

HYSTERECTOMY FORCEPS

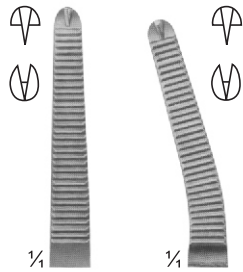
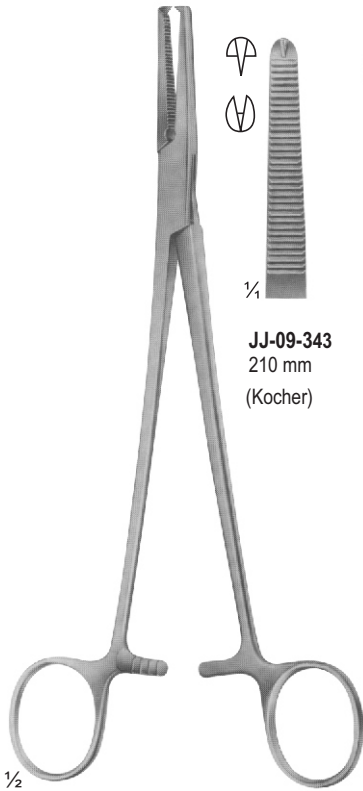

JJ-09-343
210 mm
(Kocher)

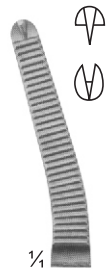

JJ-09-344
205 mm
(Kocher)

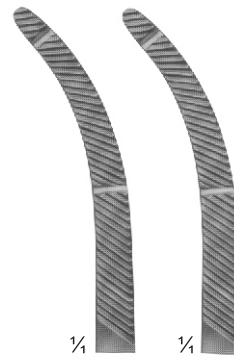
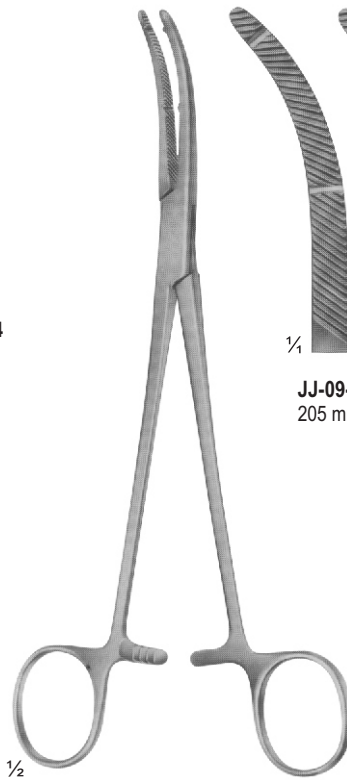

JJ-09-345
205 mm



JJ-09-346
245 mm

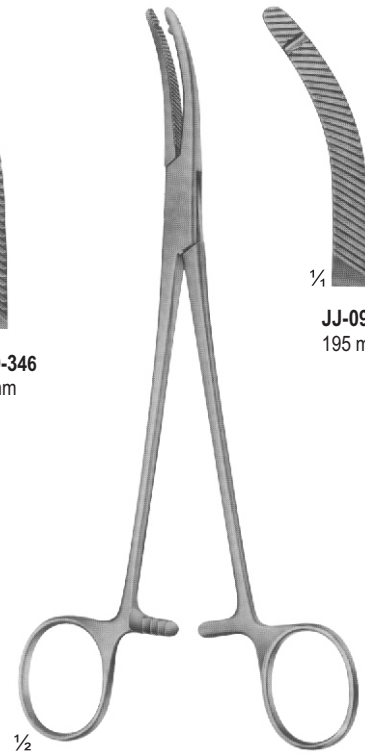

JJ-09-347
195 mm

JJ-09-343 - JJ-09-344
PHANEUF

JJ-09-345 - JJ-09-346
HEANEY modif.

JJ-09-347
HEANEY

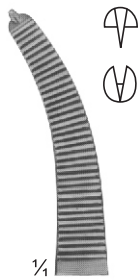
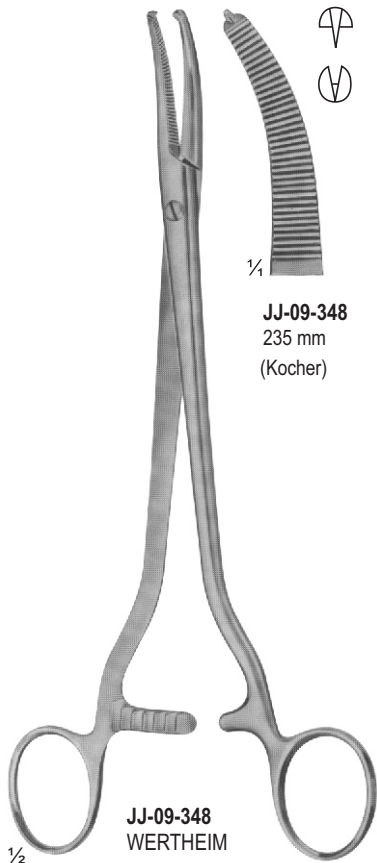

JJ-09-348
235 mm
(Kocher)

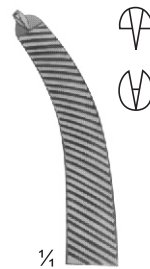
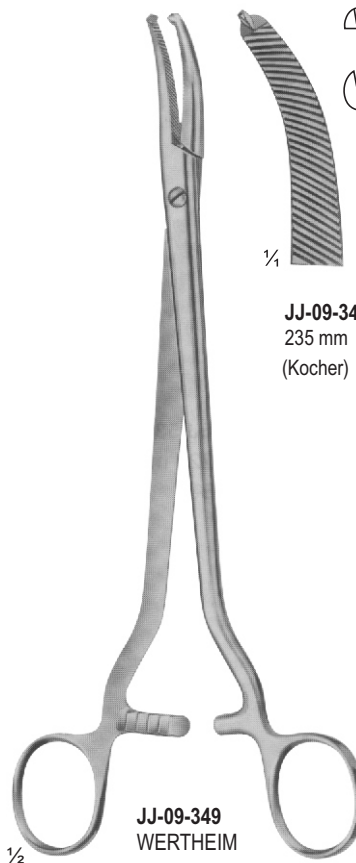

JJ-09-349
235 mm
(Kocher)

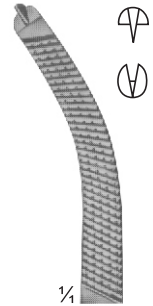
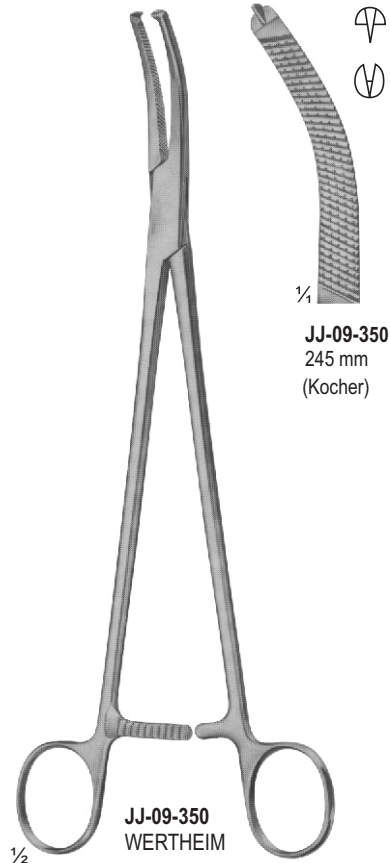

JJ-09-350
245 mm
(Kocher)

JJ-09-348
WERTHEIM

JJ-09-349
WERTHEIM

JJ-09-350
WERTHEIM



JJ-09-351
225 mm

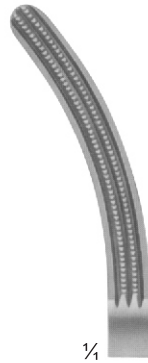

JJ-09-352
220 mm



JJ-09-353
215 mm

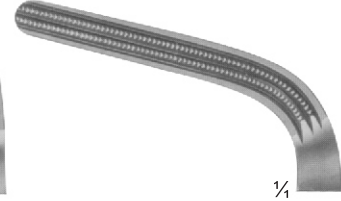

JJ-09-354
205 mm

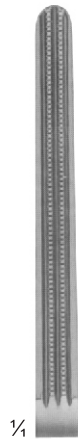

JJ-09-355
250 mm

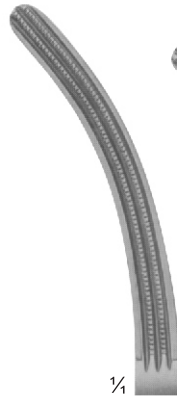

JJ-09-356
245 mm



JJ-09-357
240 mm

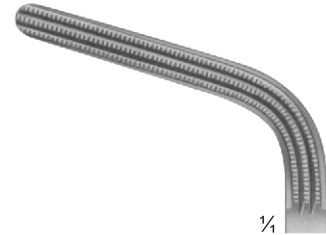

JJ-09-358
220 mm

HYSTERECTOMY FORCEPS, VAGINAL CLAMPS AND COMPRESSION FORCEPS

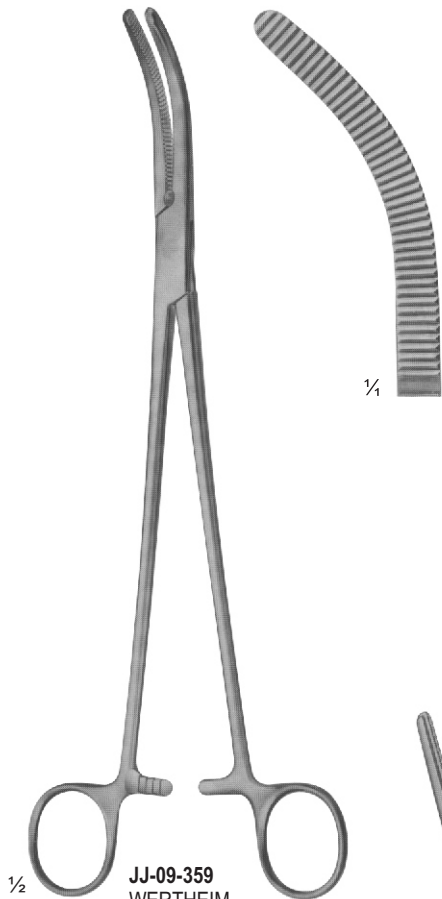

$\frac{1}{2}$ **JJ-09-359**
WERTHEIM
 Hysterectomy Forceps
 255 mm

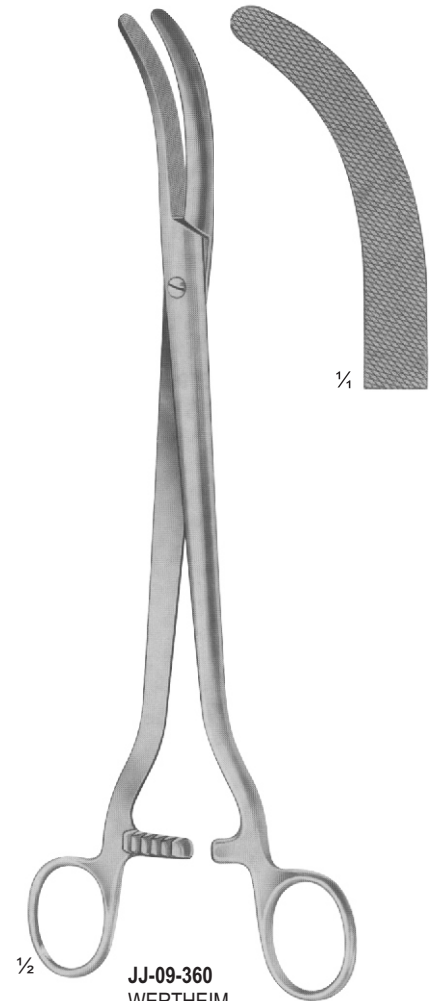

$\frac{1}{2}$ **JJ-09-360**
WERTHEIM
 Parametrium Clamp
 260 mm

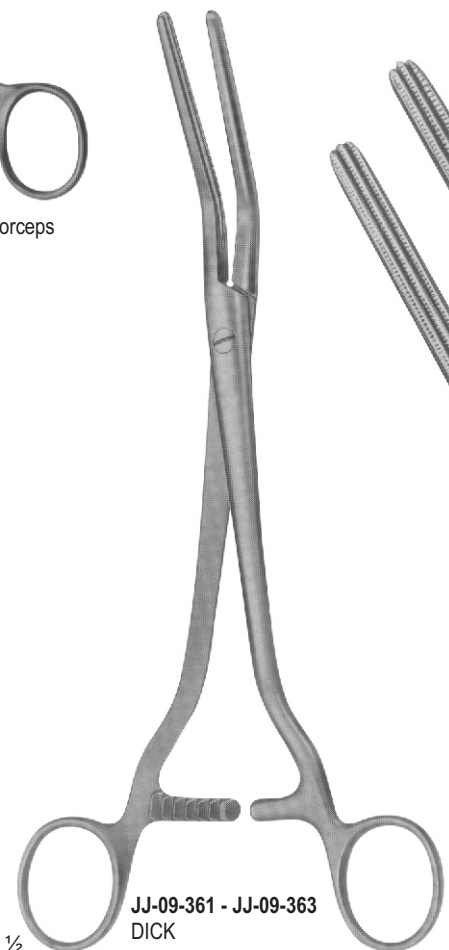

$\frac{1}{2}$ **JJ-09-361 - JJ-09-363**
DICK

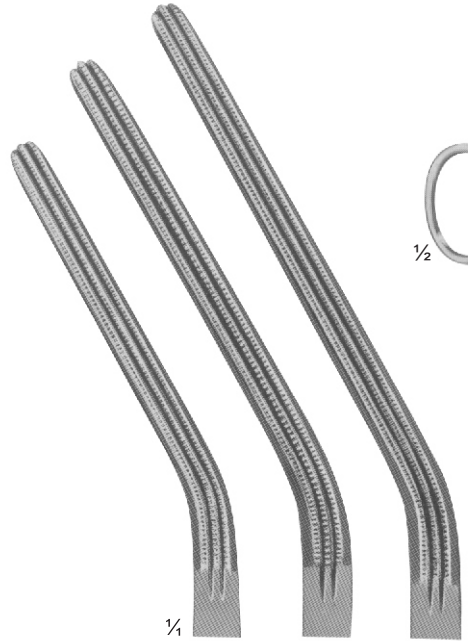

$\frac{1}{4}$ **JJ-09-361** 255 mm **JJ-09-362** 265 mm **JJ-09-363** 275 mm

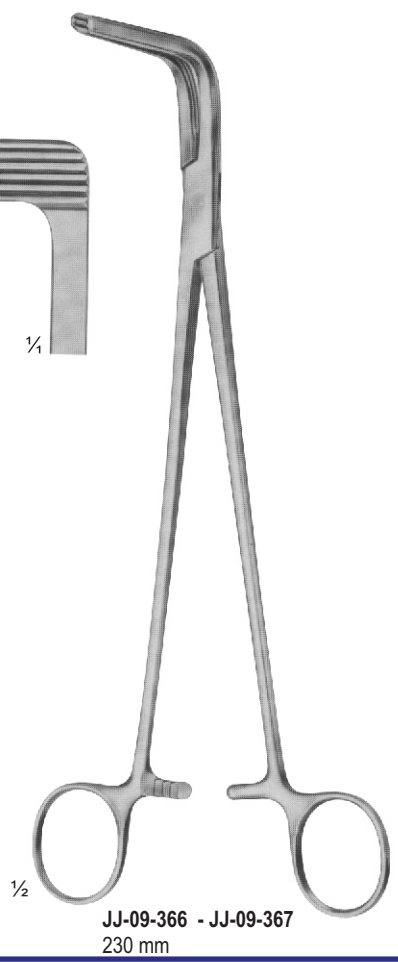
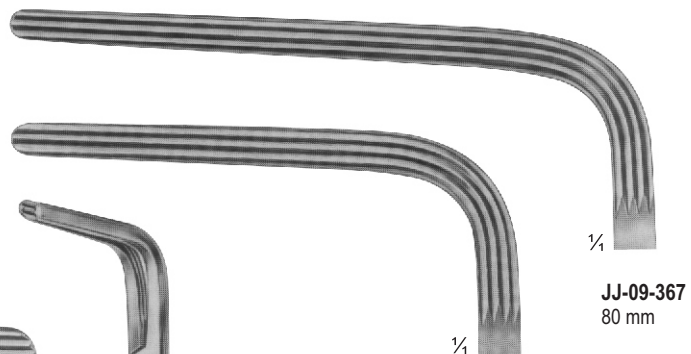
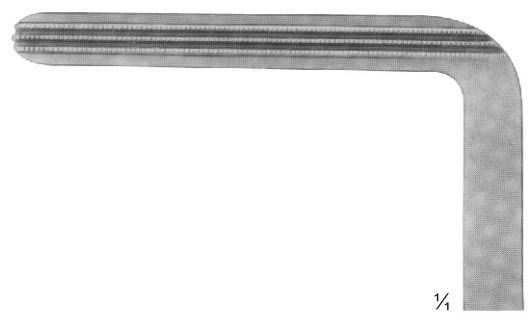
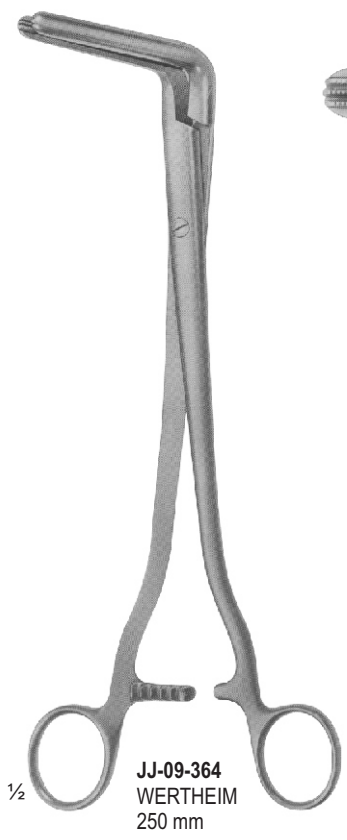

DELICATE HAEMOSTATIC FORCEPS

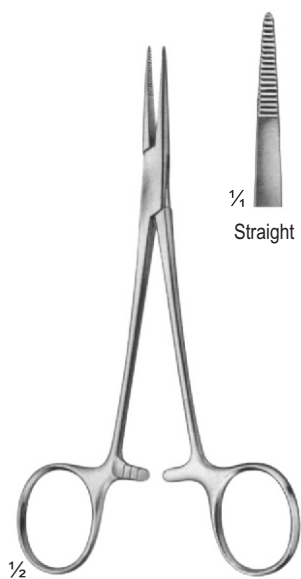

PROVIDENCE-HOSPITAL
JJ-09-368
140 mm

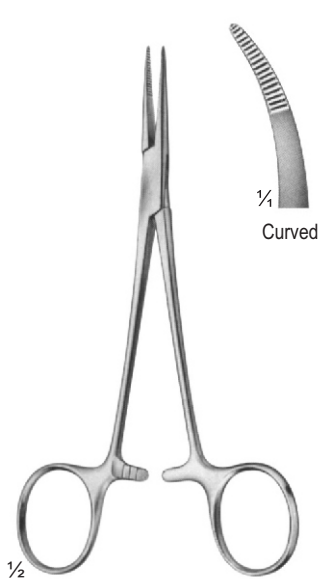

PROVIDENCE-HOSPITAL
JJ-09-369
140 mm

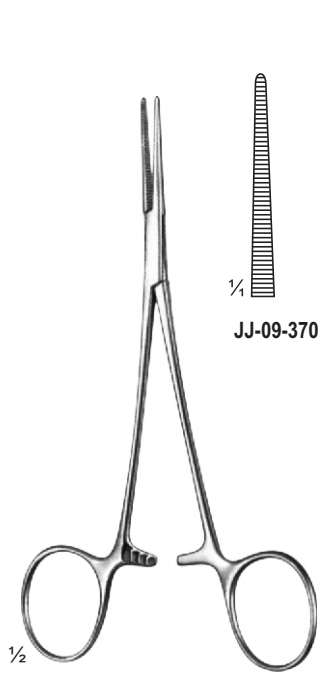

LERICHE
JJ-09-370 155 mm
JJ-09-371 150 mm

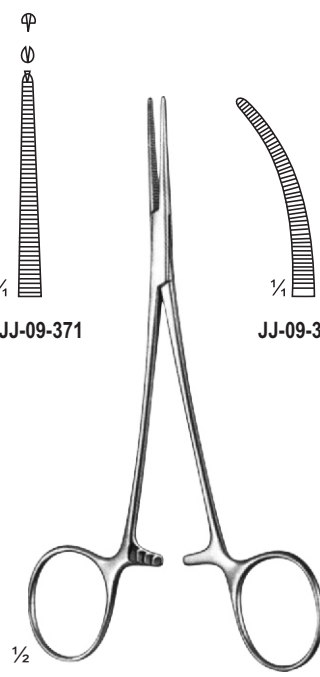

LERICHE
JJ-09-372 155 mm
JJ-09-373 150 mm

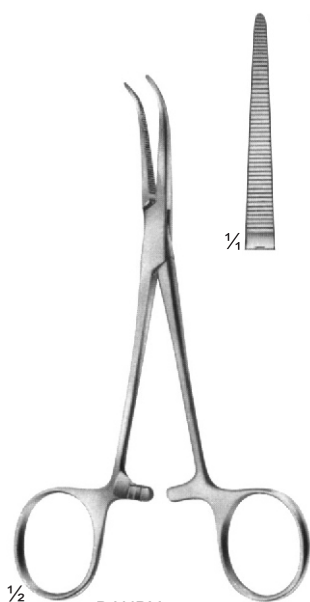

DANDY
JJ-09-374 120 mm
JJ-09-375 140 mm

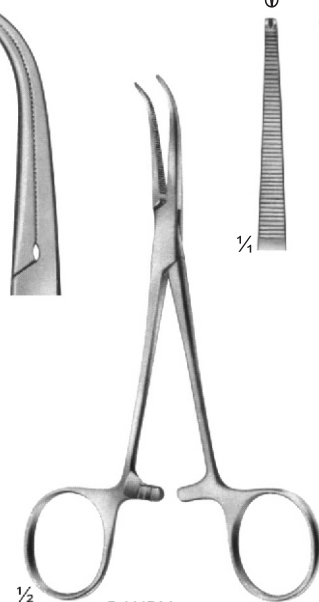

DANDY
JJ-09-376 120 mm
JJ-09-377 140 mm

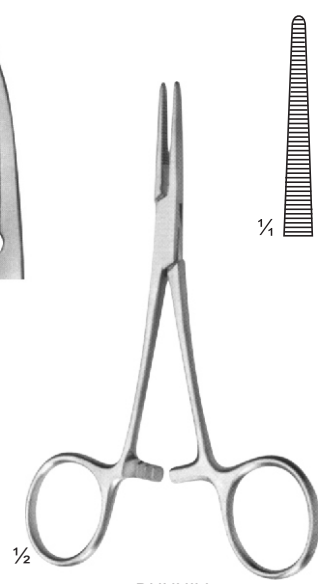

DUNHILL
JJ-09-378
125 mm

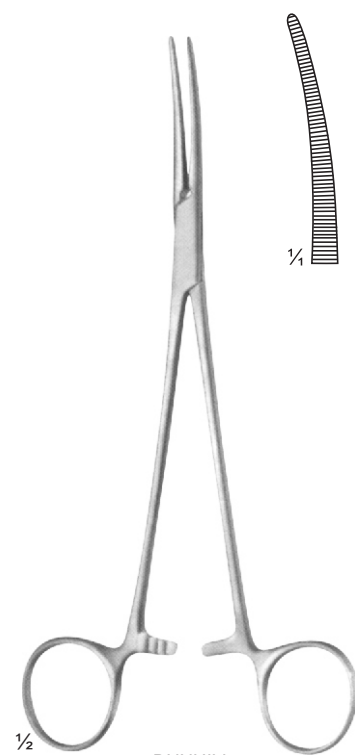

DUNHILL
JJ-09-379
185 mm

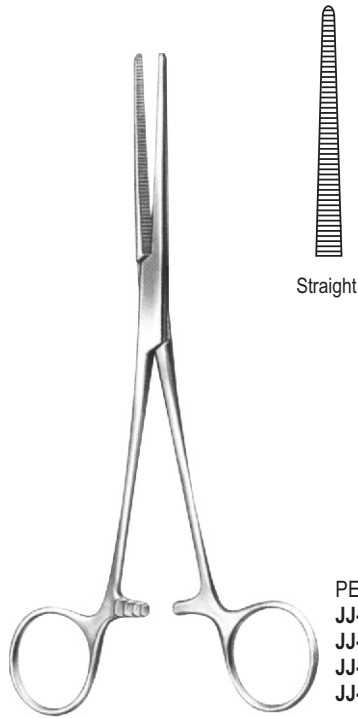

PEAN
JJ-09-380 - JJ-09-382
JJ-09-380 130 mm
JJ-09-381 140 mm
JJ-09-382 170 mm

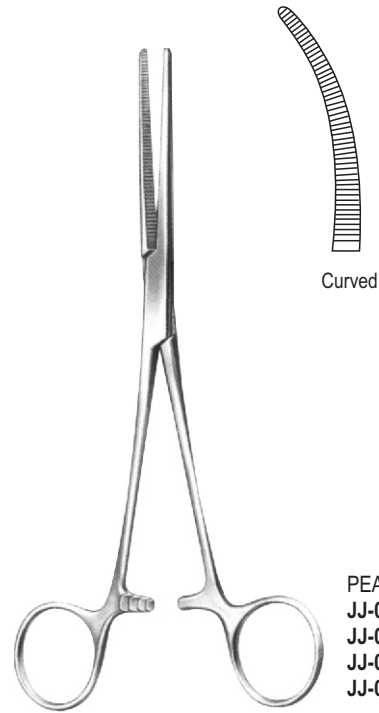

PEAN
JJ-09-383 - JJ-09-385
JJ-09-383 130 mm
JJ-09-384 140 mm
JJ-09-385 170 mm

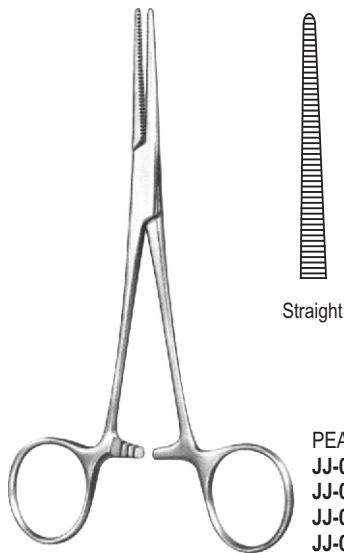

PEAN-Delicate
JJ-09-386 - JJ-09-388
JJ-09-386 140 mm
JJ-09-387 160 mm
JJ-09-388 180 mm

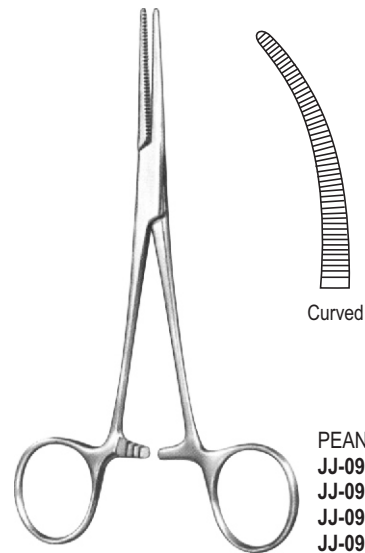

PEAN-Delicate
JJ-09-389 - JJ-09-391
JJ-09-389 140 mm
JJ-09-390 160 mm
JJ-09-391 180 mm

DISSECTING- AND LIGATURE FORCEPS

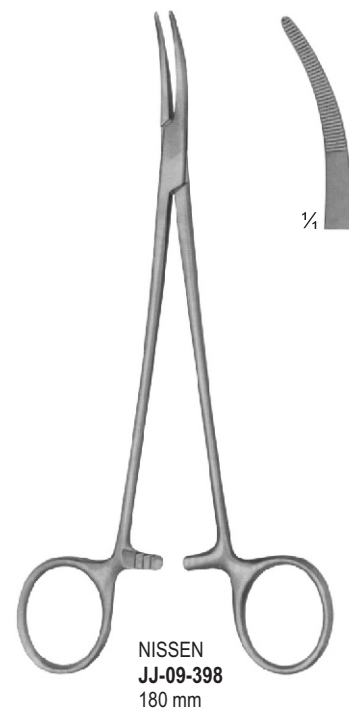
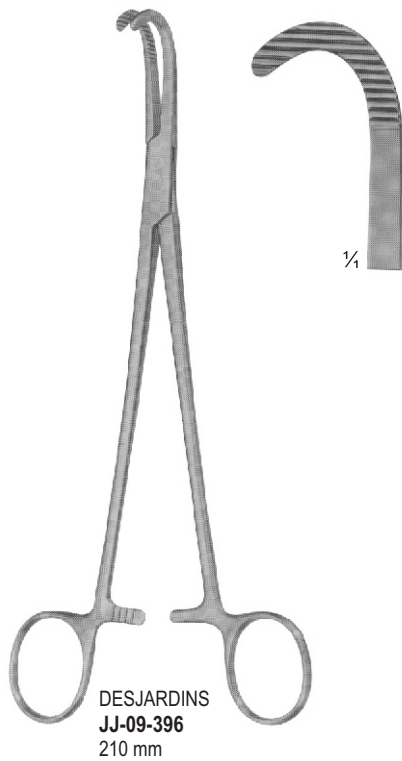
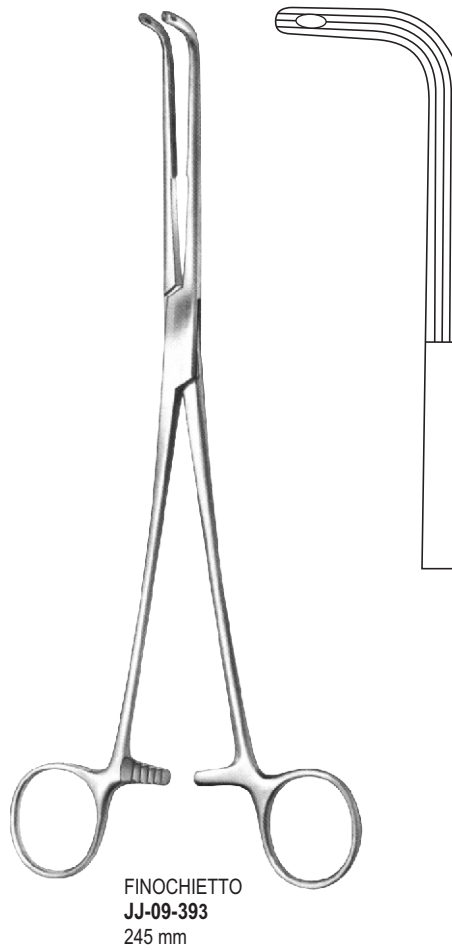
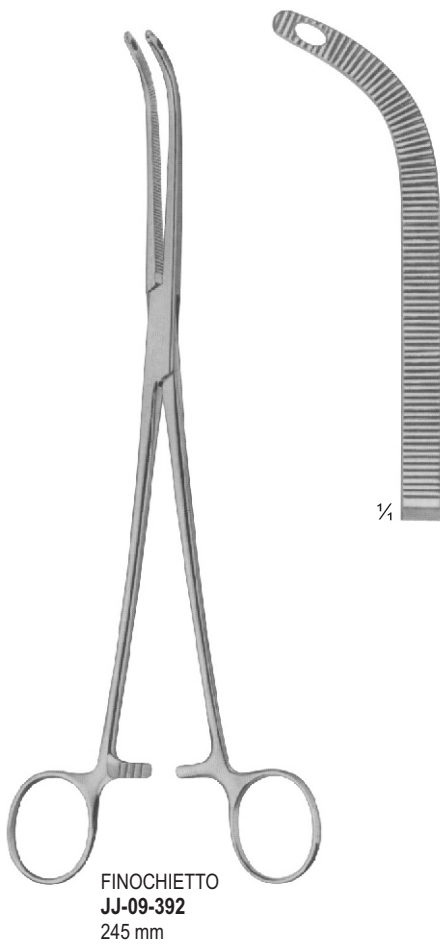

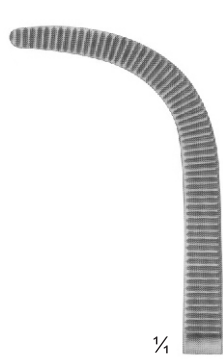

¼

JJ-09-399

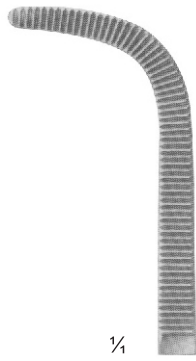

¼

JJ-09-400

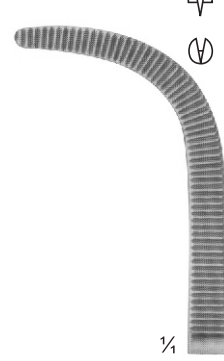

¼

JJ-09-401

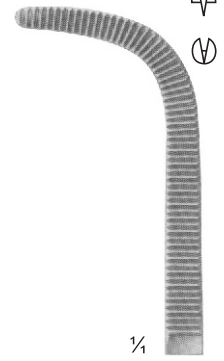

¼

JJ-09-402

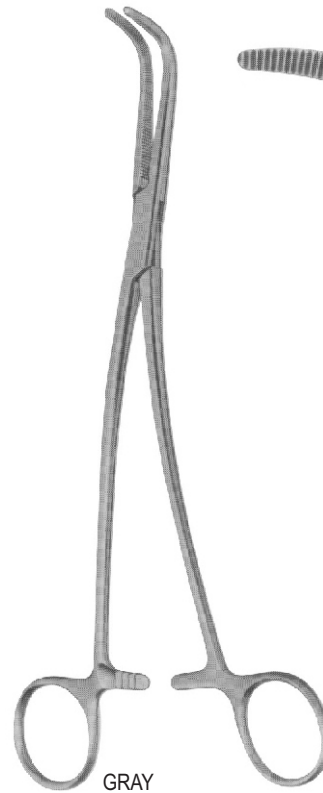

GRAY
JJ-09-401 - JJ-09-402
220 mm

GRAY
JJ-09-399 - JJ-09-300
220 mm



¼

JJ-09-403



¼

JJ-09-404



NEGUS
JJ-09-403 - JJ-09-404
190 mm

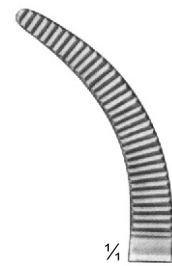

¼

JJ-09-405
230 mm



¼

JJ-09-406
240 mm



MOYNIHAN
JJ-09-405 - JJ-09-406

TUBING CLAMPS

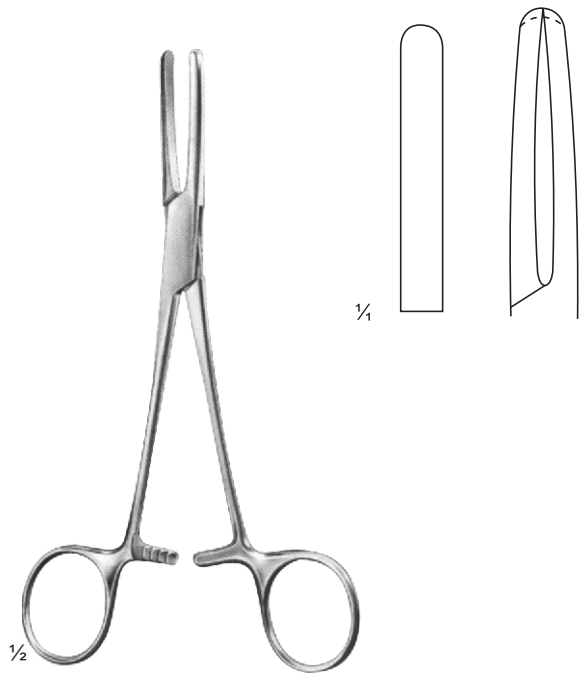

JJ-09-407
16.5 cm

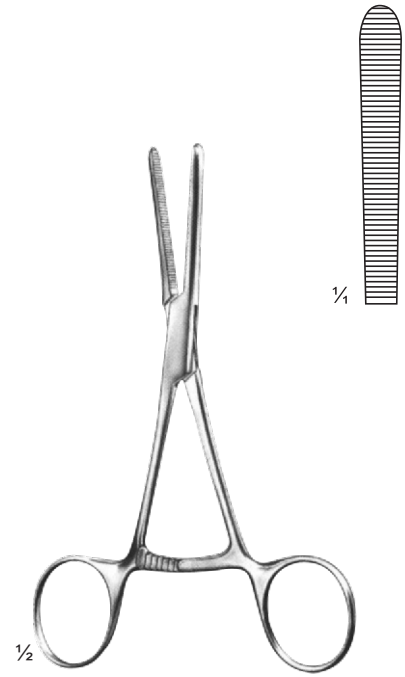
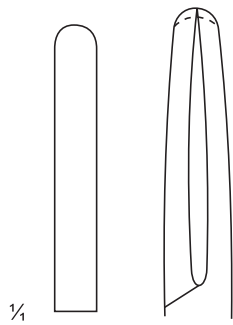

JJ-09-408
14 cm

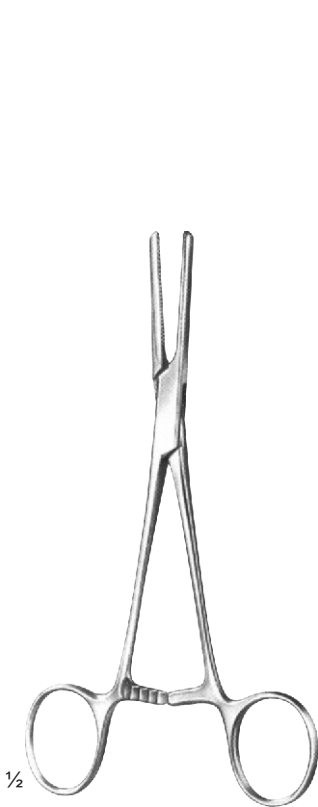
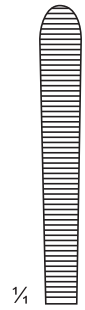

JJ-09-409 - JJ-09-410

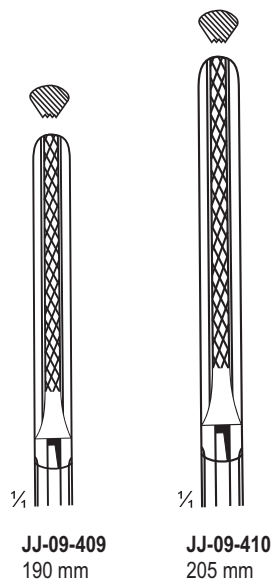

JJ-09-409
190 mm

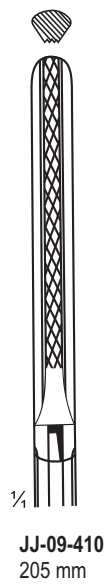

JJ-09-410
205 mm

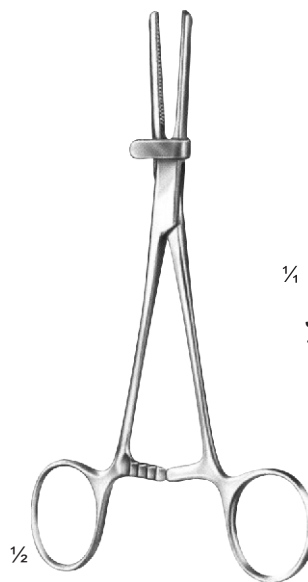

JJ-09-411 - JJ-09-413

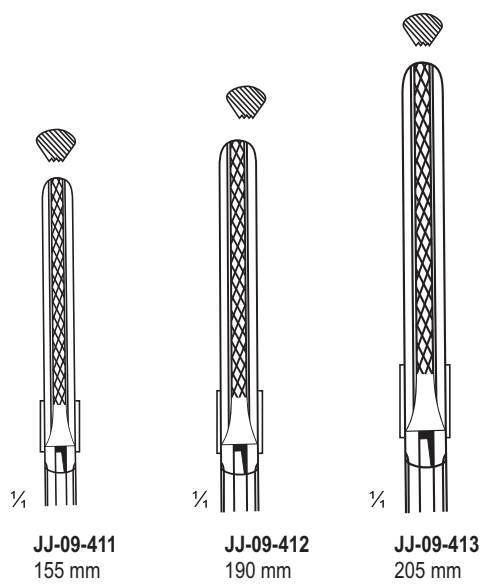

JJ-09-411
155 mm

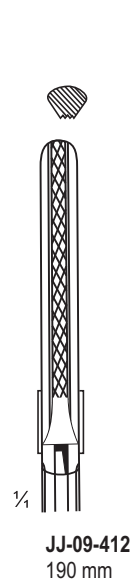

JJ-09-412
190 mm

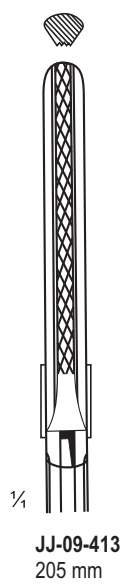

JJ-09-413
205 mm

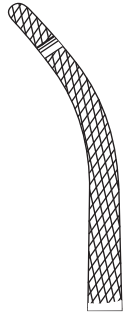

Fig. 1
JJ-09-414
195 mm

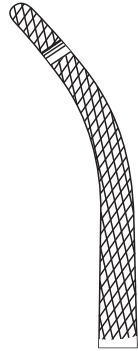

Fig. 1
JJ-09-415
215 mm

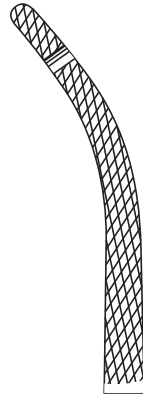

Fig. 1
JJ-09-416
240 mm

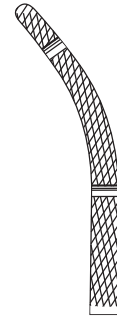

Fig. 2
JJ-09-417
195 mm



Fig. 2
JJ-09-418
215 mm

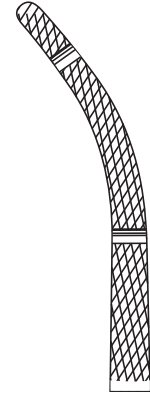
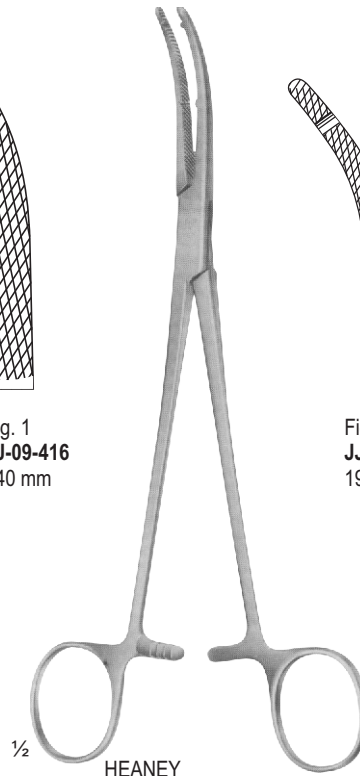
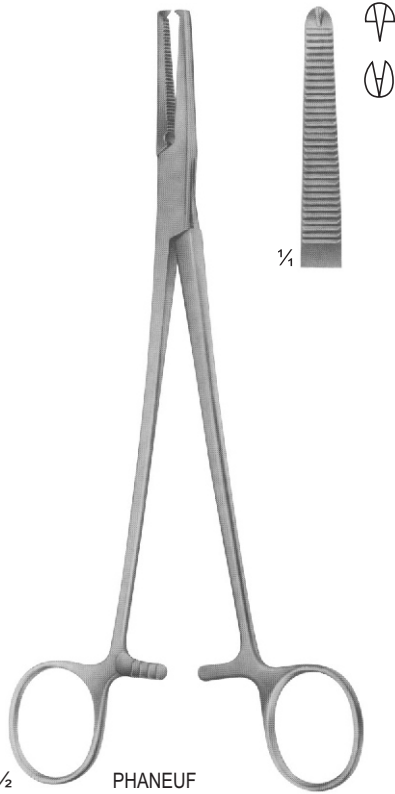

Fig. 2
JJ-09-419
240 mm



1/2
HEANEY
JJ-09-417 - JJ-09-419

1/2
HEANEY
JJ-09-414 - JJ-09-416



1/2
PHANEUF
JJ-09-420 210 mm
JJ-09-421 200 mm

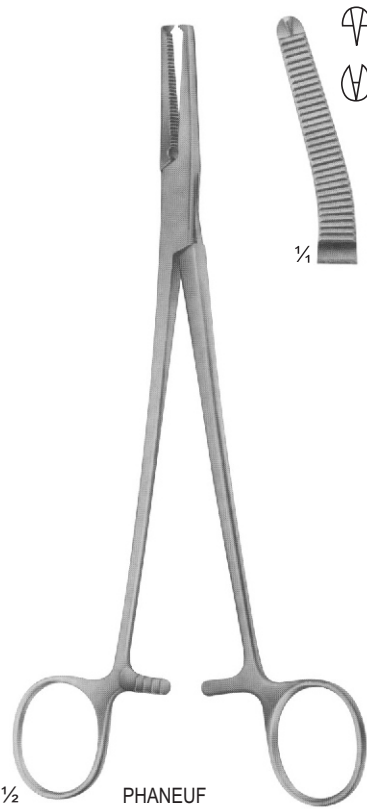

1/2
PHANEUF
JJ-09-422 210 mm
JJ-09-423 200 mm

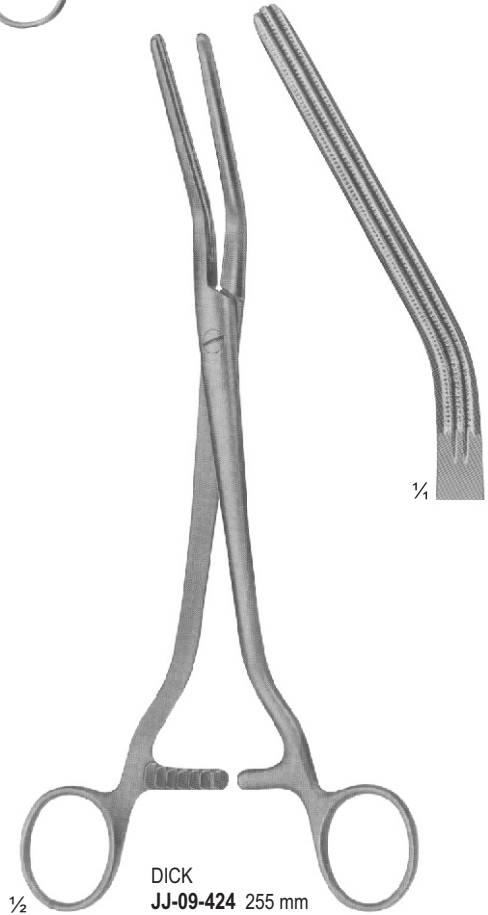

1/2
DICK
JJ-09-424 255 mm
JJ-09-425 265 mm
JJ-09-426 275 mm

Page
186–222

▪ ENT Surgery

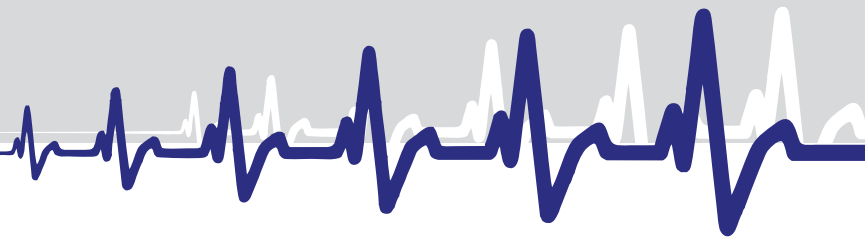



1/4

ZÖLLNER
JJ-10-101 - JJ-10-1006
set for adults, black



1:1

JJ-10-101
Fig.1
5.5 X 6.5 mm Ø



1:1

JJ-10-102
Fig.2
6.5 X 7.5 mm Ø



1:1

JJ-10-103
Fig.3
7.5 X 8.5 mm Ø



1:1

JJ-10-104
Fig.4
8.5 X 9.5 mm Ø



1:1

JJ-10-105
Fig.5
9.5 X 10.5 mm Ø

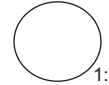

1:1

JJ-10-106
Fig.6
10.5 X 11.5 mm Ø



1/4

POLITZER
JJ-10-107 - JJ-10-110
set for adults

○ 1:1

JJ-10-107
Fig.1
2 mm Ø

○ 1:1

JJ-10-108
Fig.2
3 mm Ø

○ 1:1

JJ-10-109
Fig.3
4 mm Ø

○ 1:1

JJ-10-110
Fig.4
5 mm Ø



1/4

BOUCHERON
JJ-10-111 - JJ-10-113
set for children

○ 1:1

JJ-10-111
Fig.0
3.0 mm Ø

○ 1:1

JJ-10-112
Fig.1
4.5 mm Ø

○ 1:1

JJ-10-113
Fig.2
5.5 mm Ø



1/4

HARTMANN
JJ-10-114 - JJ-10-117
set for adults

○ 1:1

JJ-10-114
Fig.1
4.5 mm Ø

○ 1:1

JJ-10-115
Fig.2
5.5 mm Ø

○ 1:1

JJ-10-116
Fig.3
6.5 mm Ø

○ 1:1

JJ-10-117
Fig.4
7.5 mm Ø

EAR CURETTES



BUCK
JJ-10-118 - JJ-10-133
 Blunt
 Sharp
 165 mm - 6½"

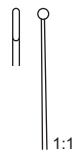

JJ-10-118
 Fig.000



JJ-10-119
 Fig.00



JJ-10-120
 Fig.0



JJ-10-121
 Fig.1



JJ-10-122
 Fig.2



JJ-10-123
 Fig.3



JJ-10-124
 Fig.4



JJ-10-125
 Fig.5



JJ-10-126
 Fig.000



JJ-10-127
 Fig.00



JJ-10-128
 Fig.0



JJ-10-129
 Fig.1



JJ-10-130
 Fig.2



JJ-10-131
 Fig.3



JJ-10-132
 Fig.4



JJ-10-133
 Fig.5



BUCK
JJ-10-134 - JJ-10-149
 Curved, blunt
 Curved, sharp
 165 mm - 6½"



JJ-10-134
 Fig.000



JJ-10-135
 Fig.00



JJ-10-136
 Fig.0



JJ-10-137
 Fig.1



JJ-10-138
 Fig.2



JJ-10-139
 Fig.3



JJ-10-140
 Fig.4



JJ-10-141
 Fig.5



JJ-10-142
 Fig.000



JJ-10-143
 Fig.00



JJ-10-144
 Fig.0



JJ-10-145
 Fig.1



JJ-10-146
 Fig.2



JJ-10-147
 Fig.3



JJ-10-148
 Fig.4



JJ-10-149
 Fig.5

Picture Show The Outer Diameter



LANGENBECK
JJ-10-150
Blunt
130 mm - 5"

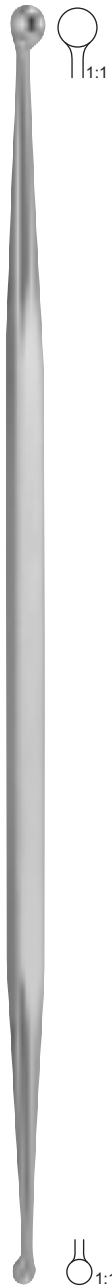

JANSEN
JJ-10-151
Sharp
170 mm - 6 3/4"



GROSS
JJ-10-152
Sharp, not fenestrated
120 mm - 4 3/4"

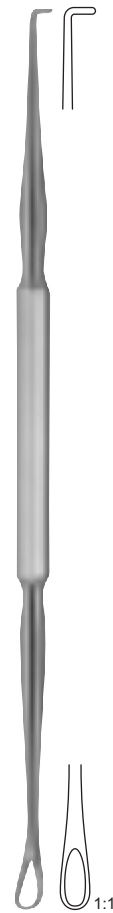

JJ-10-153
Blunt, fenestrated
120 mm - 4 3/4"



JANSEN
JJ-10-154
Sharp
160 mm - 6 1/4"

EAR LOOPS - HOOKS



BILLEAU
JJ-10-155 - JJ-10-157
 165 mm - 6½"

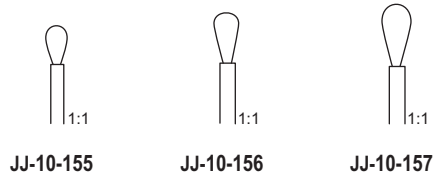

JJ-10-155

JJ-10-156

JJ-10-157



LUCAE
JJ-10-158 - JJ-10-160
 140 mm - 5½"

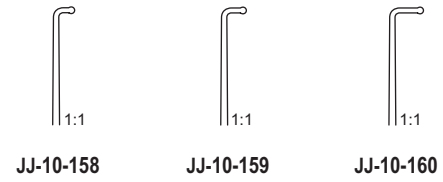

JJ-10-158

JJ-10-159

JJ-10-160



WAGENER
JJ-10-161 - JJ-10-167
 140 mm - 5½"

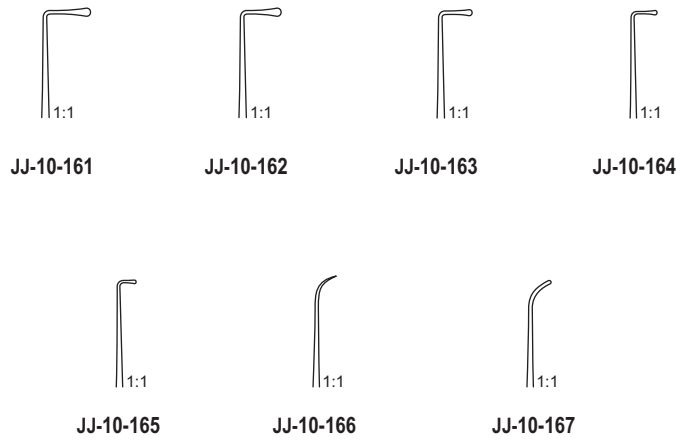

JJ-10-161

JJ-10-162

JJ-10-163

JJ-10-164

JJ-10-165

JJ-10-166

JJ-10-167

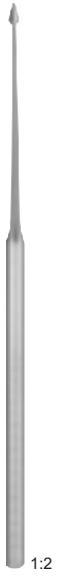

1:2



1:1

POLITZER
JJ-10-168
150 mm - 6"



1:1

GERZOG
JJ-10-169
160 mm - 6 1/4"



1:1

BUCK
JJ-10-170
160 mm - 6 1/4"



1:2



1:1

LUCAE
JJ-10-171
180 mm - 7"



1:2



1:1

LUCAE
JJ-10-172
180 mm - 7"

JJ-10-168 - JJ-10-170



1:2



1:1

LUCAE
JJ-10-173
190 mm - 7 1/2"



1:2



1:1

POLITZER
JJ-10-174
170 mm - 7 3/4"

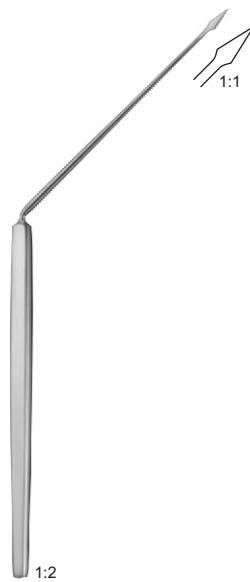

1:2



1:1

POLITZER
JJ-10-175
needle vertical
160 mm - 6 1/4"



1:2



1:1

JJ-10-176
Needle horizontal
160 mm - 6 1/4"

EAR FORCEPS AND MICRO EAR FORCEPS

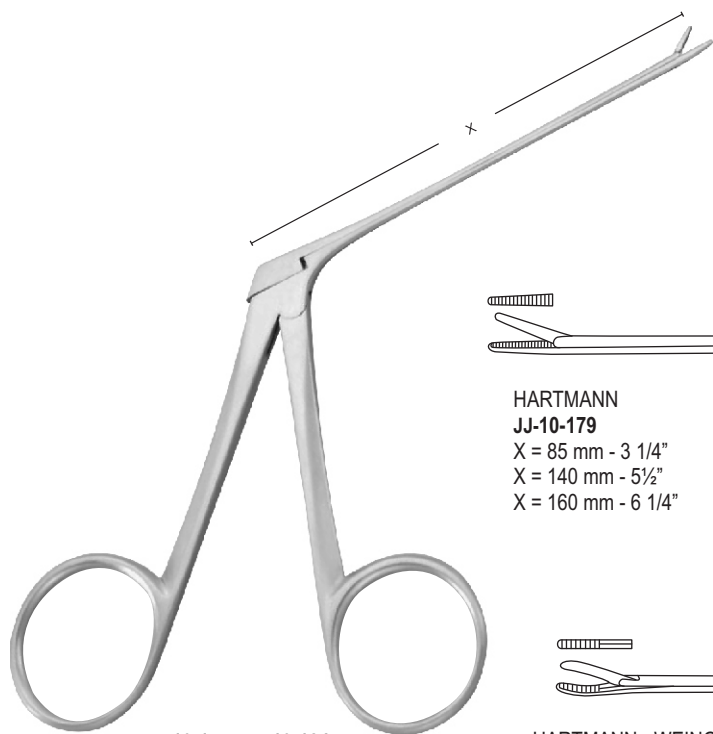

JJ-10-177 - JJ-10-184

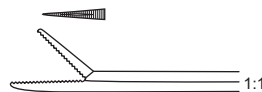

**HARTMANN - WULLSTEIN
JJ-10-177**
X = 85 mm - 3 1/4"



**HARTMANN - WULLSTEIN
JJ-10-178**
X = 85 mm - 3 1/4" 1 mm ø

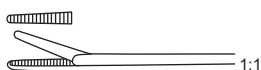

**HARTMANN
JJ-10-179**
X = 85 mm - 3 1/4"
X = 140 mm - 5 1/2"
X = 160 mm - 6 1/4"



**HARTMANN
JJ-10-180**
X = 85 mm - 3 1/4"
X = 140 mm - 5 1/2"

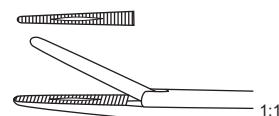

**HARTMANN - NOYES
JJ-10-181**
X = 90 mm - 3 1/2"



**HARTMANN - WEINGARTNER
JJ-10-182**
X = 85 mm - 3 1/4"



**HARTMANN
JJ-10-183**
X = 85 mm - 3 1/4"
2.0 mm ø
2.5 mm ø
3.0 mm ø



**STRUEMPEL
JJ-10-184**
X = 85 mm - 3 1/4"

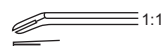

**MCGEE
JJ-10-185**
wire bending forceps
3.5 mm X 0.8 mm



**FULLER
JJ-10-186**
introducing forceps
for teflon prosthesis
80 mm - 3 1/4"



JJ-10-187
Up - cutting



JJ-10-188
Down - cutting



JJ-10-189
Right - cutting



JJ-10-190
Left - cutting

**DIETER
JJ-10-185 - JJ-10-190**
malleus nipper
X = 80 mm - 3 1/4"



JJ-10-191 - JJ-10-195

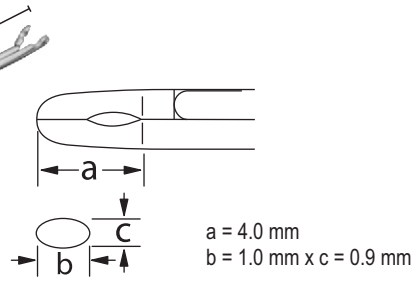

JJ-10-191
Straight, oval
X = 75 mm - 3"



JJ-10-192
Curved upwards, oval
X = 75 mm - 3"



JJ-10-193
Curved to left, oval
X = 75 mm - 3"



JJ-10-194
Curved to right, oval
X = 75 mm - 3"



JJ-10-195
Curved downwards, oval
X = 75 mm - 3"

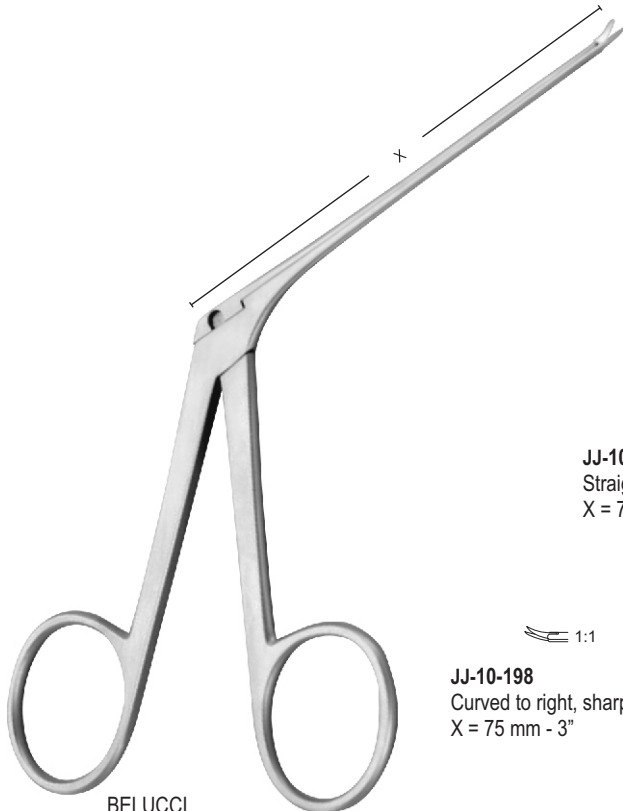

BELUCCI
JJ-10-196 - JJ-10-200

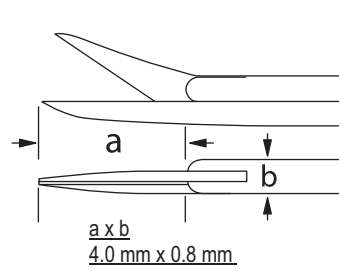

JJ-10-196
Straight, sharp/sharp
X = 75 mm - 3"



JJ-10-197
Curved upwards, blunt/blunt
X = 75 mm - 3"



JJ-10-198
Curved to right, sharp/sharp
X = 75 mm - 3"



JJ-10-199
Curved to left, sharp/sharp
X = 75 mm - 3"



JJ-10-200
straight, sharp/blunt
X = 75 mm - 3"

MICRO EAR RASPATORIES AND PROBES
 EAR SICKLEKNIVES - CURRCULAR CUTTING KNIFE



PLESTER
JJ-10-201 - JJ-10-206
 160 mm - 6 1/4"



WIRE GUIDE
JJ-10-201



RASPATORY
JJ-10-202



RASPATORY
JJ-10-203
 1.8 mm



JJ-10-204
 Dissector, double curved right



JJ-10-205
 Instrument for placing wire prosthesis

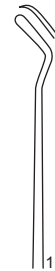

JJ-10-206
 Dissector, double curved left



ROSEN
JJ-10-207 - JJ-10-213
 160 mm - 6 1/4"



JJ-10-207
 Circular cutting knife
 1.5 mm \varnothing 90°



JJ-10-208
 Tympanum knife
 45°



JJ-10-209
 Lancet knife
 45°

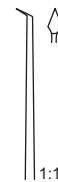

JJ-10-210
 Lancet knife



RASPATORY
JJ-10-211
 Zollner
 1 mm



JJ-10-212
 Sickle knife,
 slightly curved



JJ-10-213
 discision knife,
 straight curved



JJ-10-214 - JJ-10-219



JJ-10-214
Needle fine, straight, sharp
160 mm - 6 1/4"



JJ-10-215
Needle, slightly curved, sharp
160 mm - 6 1/4"



JJ-10-216
Needle, strong curved, sharp
160 mm - 6 1/4"



SHAMBAUGH
JJ-10-217
45° Hook, angled
160 mm - 6 1/4"



PLESTER
JJ-10-218
0.4 mm - 90°
foot plate hook, angled, blunt
160 mm - 6 1/4"



PLESTER
JJ-10-219
0.4 mm - 45°
Antrum hook, angled, blunt
160 mm - 6 1/4"



JJ-10-220 - JJ-10-223



FISCH
JJ-10-220
Angled to the right
155 mm - 6"



JJ-10-221
Angled to the left
155 mm - 6"

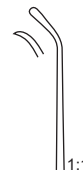

JJ-10-222
Angled to the right
155 mm - 6"



JJ-10-223
Angled to the left
155 mm - 6"



HOUSE
JJ-10-224
spoon, strong curved
spoon, slightly curves
170 mm - 6 3/4"



SHEA
JJ-10-225
straight
160 mm - 6 1/4"
1.5 mm X 2.5 mm

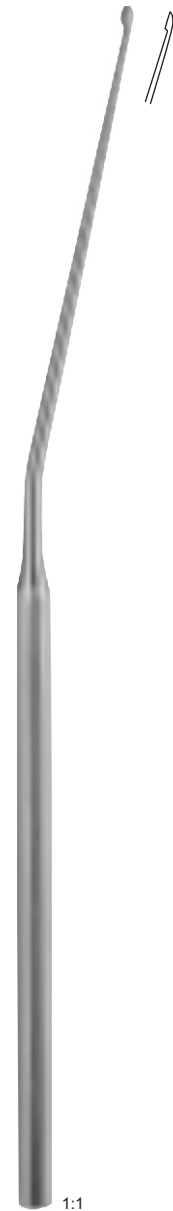

SHEA
JJ-10-226
curved
160 mm - 6 1/4"
1.5 mm X 2.5 mm



1:2
CITELLI
JJ-10-227 - JJ-10-229
X = 60 mm
170 mm - 6 3/4"



JJ-10-227
1.5 mm

JJ-10-228
2.2 mm



JJ-10-229
3.0 mm



1:2
JJ-10-230 - JJ-10-233
200 mm - 8"
X = 80 mm



JJ-10-230
3 X 3 mm

JJ-10-231
4 X 4 mm

JJ-10-232
5 X 5 mm

JJ-10-233
6 X 6 mm

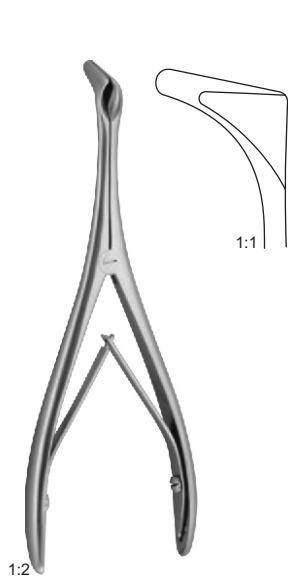
NASAL SPECULA



TIECK - HALLE
JJ-10-234
 for babies
 135 mm - 5 1/4"



BECKMANN
JJ-10-235
 150 mm - 6"



MOD. WIEN
JJ-10-236
 145 mm - 5 3/4"

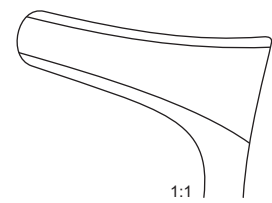
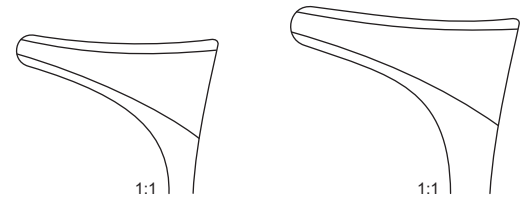

JJ-10-237 - JJ-10-240
KILLIAN
 130 mm - 5"

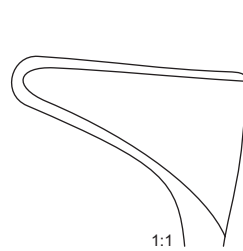

JJ-10-237
 X = 35 mm

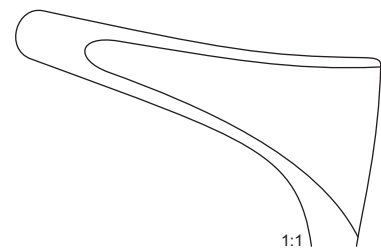

JJ-10-238
 X = 50 mm

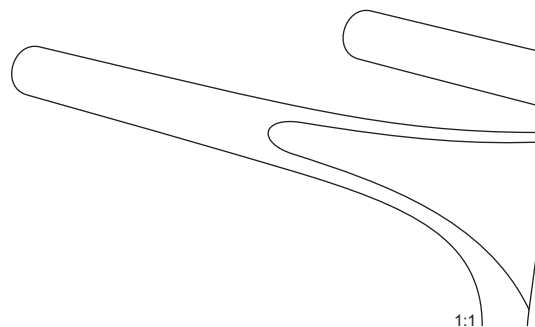

JJ-10-239
 X = 75 mm

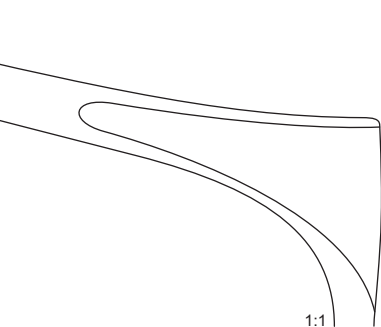

JJ-10-240
 X = 90 mm



WESTMACOTT
JJ-10-241
200 mm - 8"

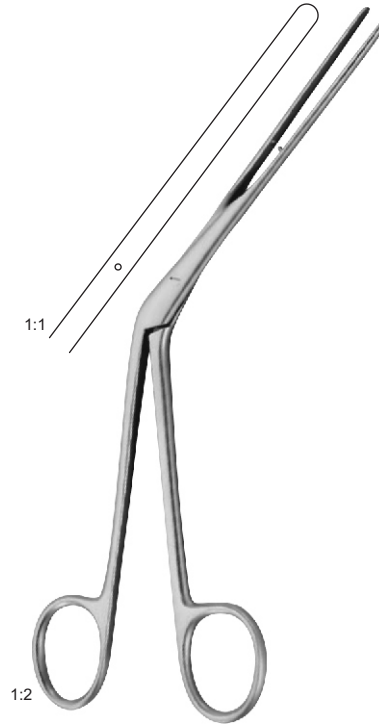

LUBET - BARBON
JJ-10-242
200 mm - 8"



HARTMANN
JJ-10-243
160 mm - 6 1/4"
200 mm - 8"

NASAL DRESSING FORCEPS

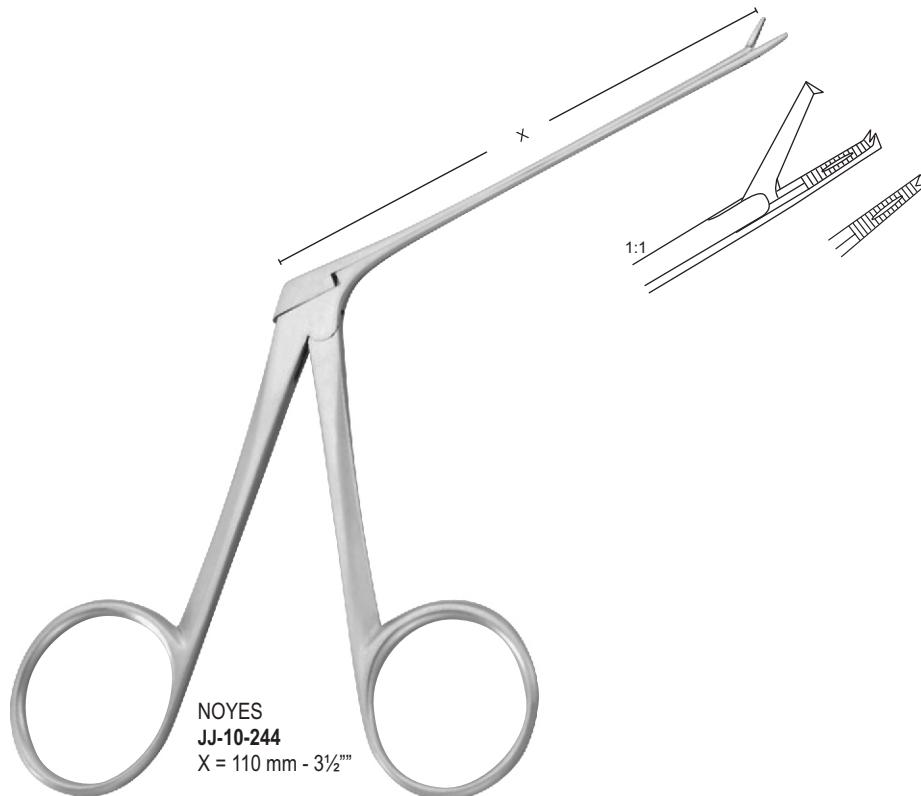

NOYES
JJ-10-244
X = 110 mm - 3 1/2"

NASAL CUTTING FORCEPS

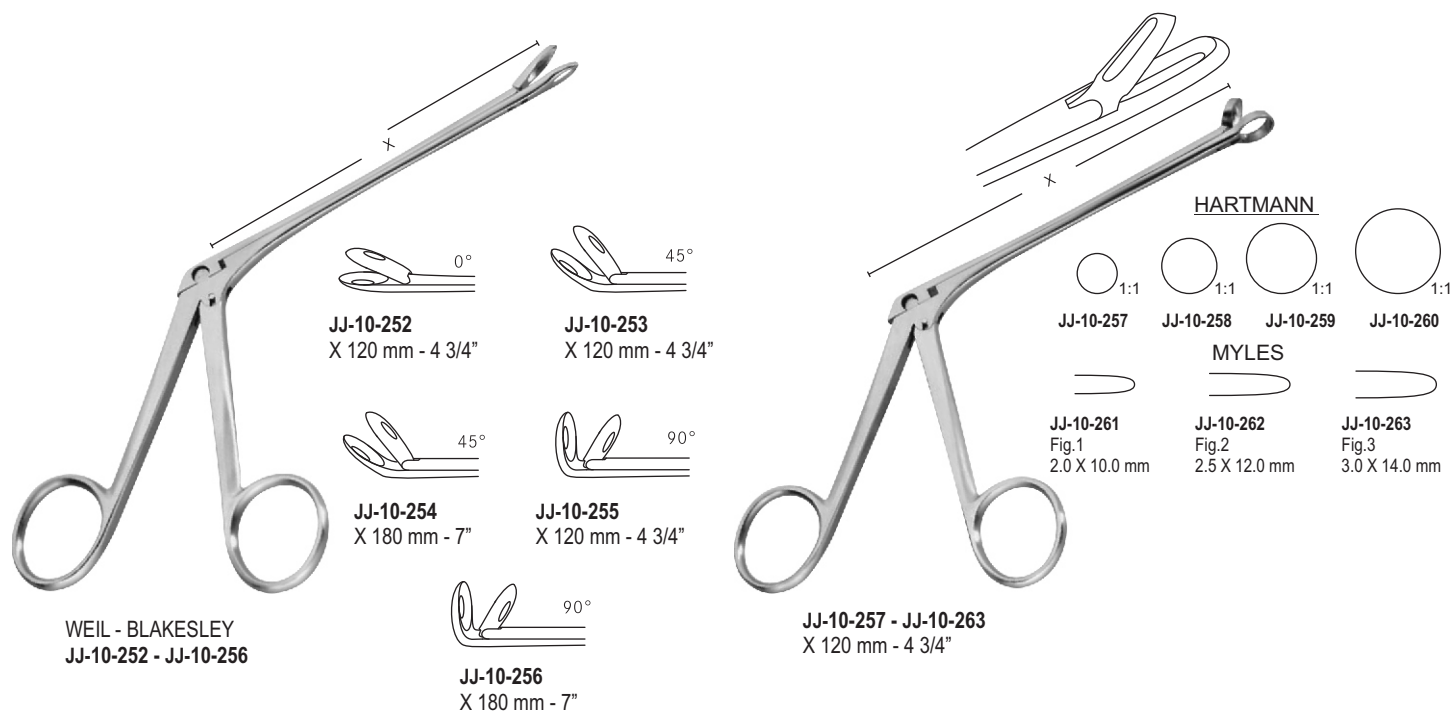
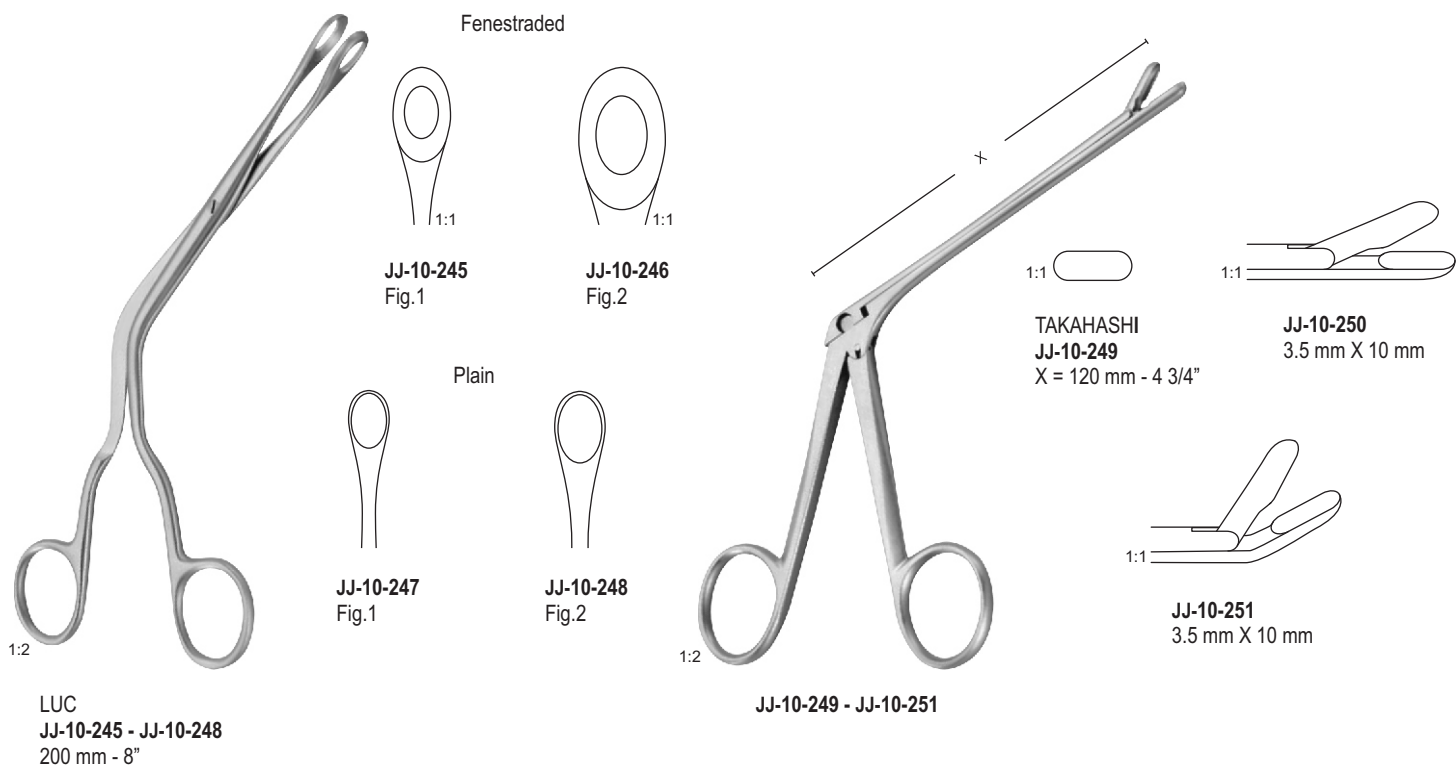

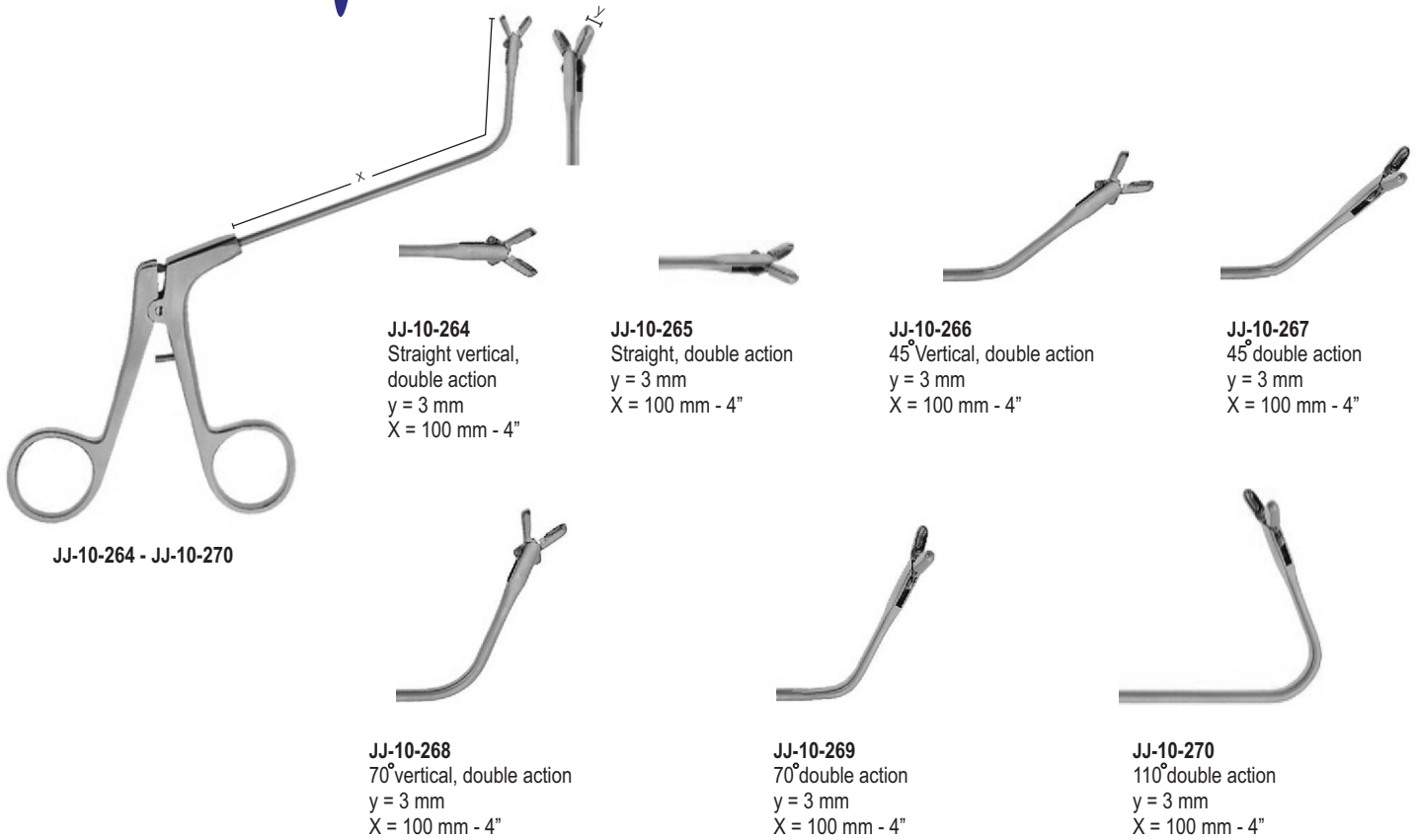

CIRCULAR FORCEPS AND ANTRUM PUNCH

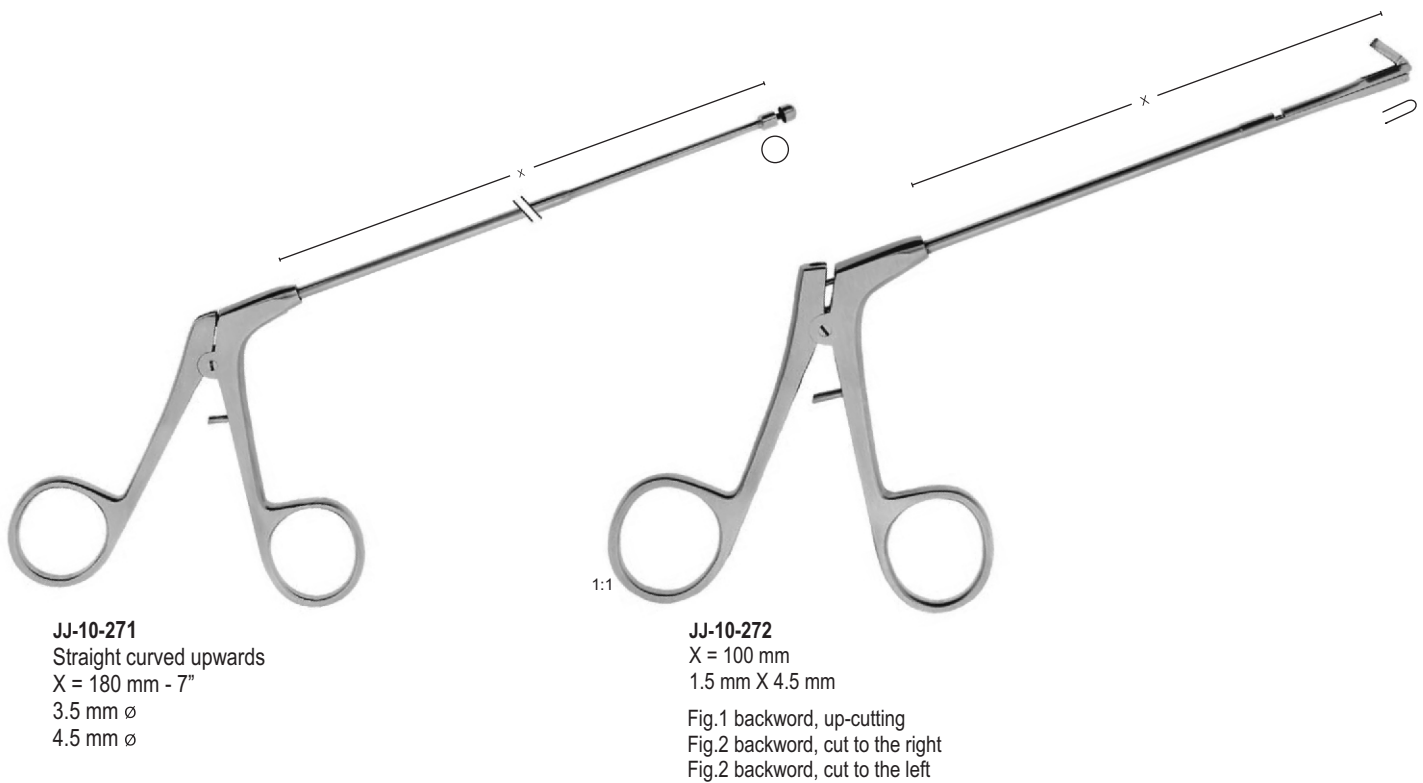

TONSIL KNIVES



1:2
FREER
JJ-10-273
210 mm - 8 1/4"



1:2
FREER
JJ-10-274
210 mm - 8 1/4"



1:2
SICKLE KNIFE
JJ-10-275
200 mm - 8"



1:2
BRUNINGS
JJ-10-276
230 mm - 9"



1:2
ABRAHAM
JJ-10-277
220 mm - 8 3/4"



1:2
FISCHER
JJ-10-278
230 mm - 9"



1:2
SHARP
JJ-10-279
200 mm - 8"



LEMPERT
JJ-10-280
200 mm - 8"
X = 6 mm

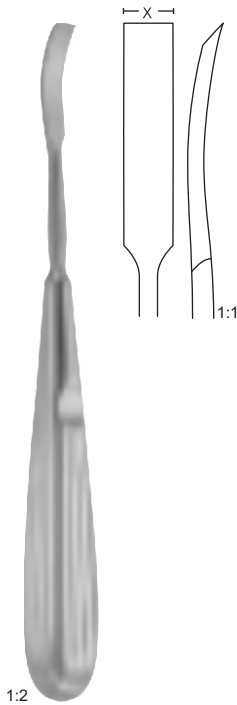

LEMPERT
JJ-10-281
180 mm - 7"

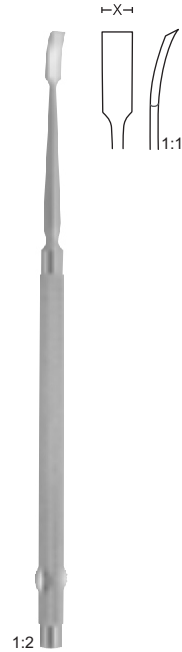

FREER
JJ-10-282
160 mm - 6 1/4"
X = 4 mm

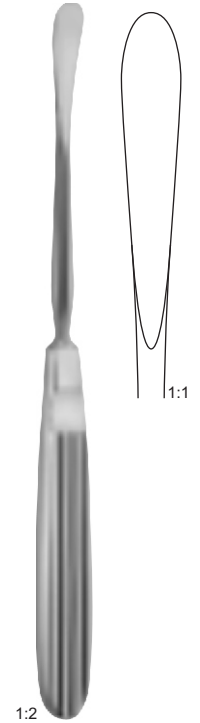

COTTLE
JJ-10-283
sharp
190 mm - 7 1/2"
X = 8 mm

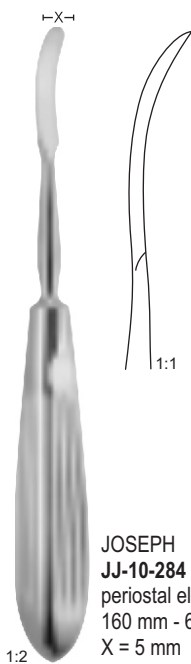

JOSEPH
JJ-10-284
periosteal elevators
160 mm - 6 1/4"
X = 5 mm

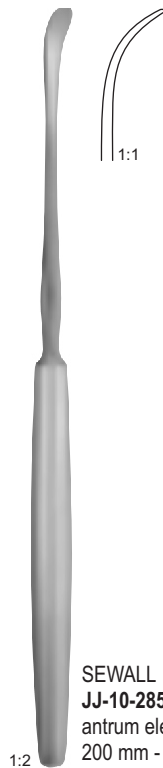

SEWALL
JJ-10-285
antrum elevators
200 mm - 8"



HALLE
JJ-10-286
antrum elevators
160 mm - 6 1/4"

PERIOSTEAL ELEVATORS

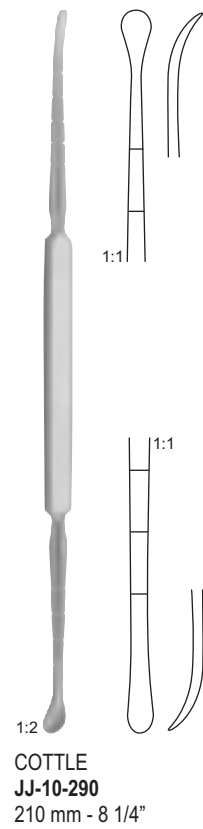
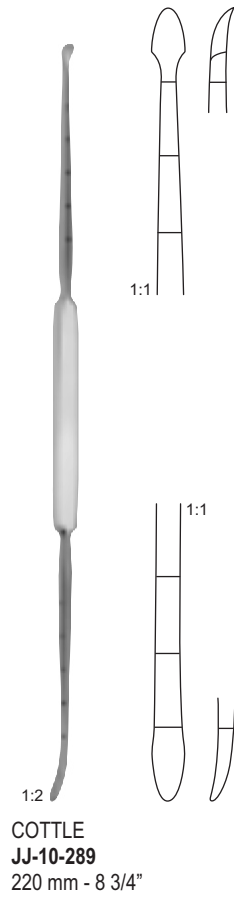
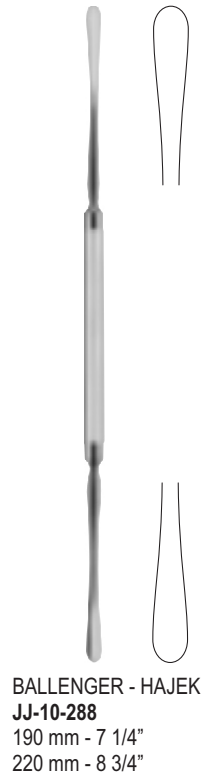
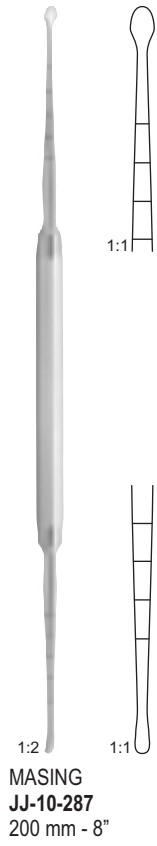

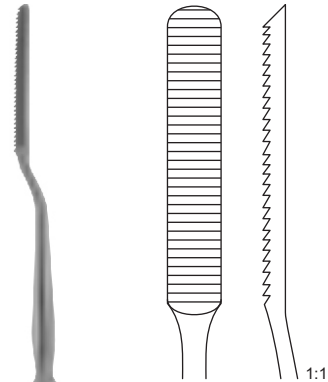

1:2

COTTLE
JJ-10-291
210 mm - 8 1/4"

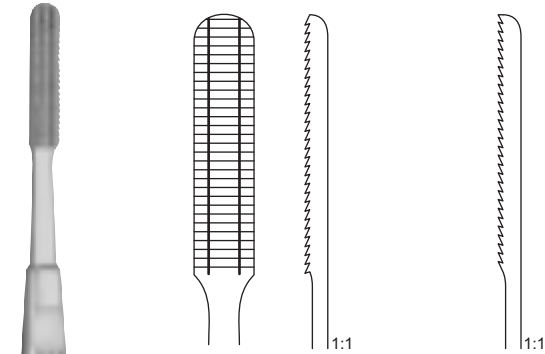

1:2

MALTZ
JJ-10-292 - JJ-10-293

JJ-10-292
Drawing cut
170 mm - 6 3/4"
34 mm X 7 mm

JJ-10-293
Pushing cut
170 mm - 6 3/4"
34 mm X 7 mm

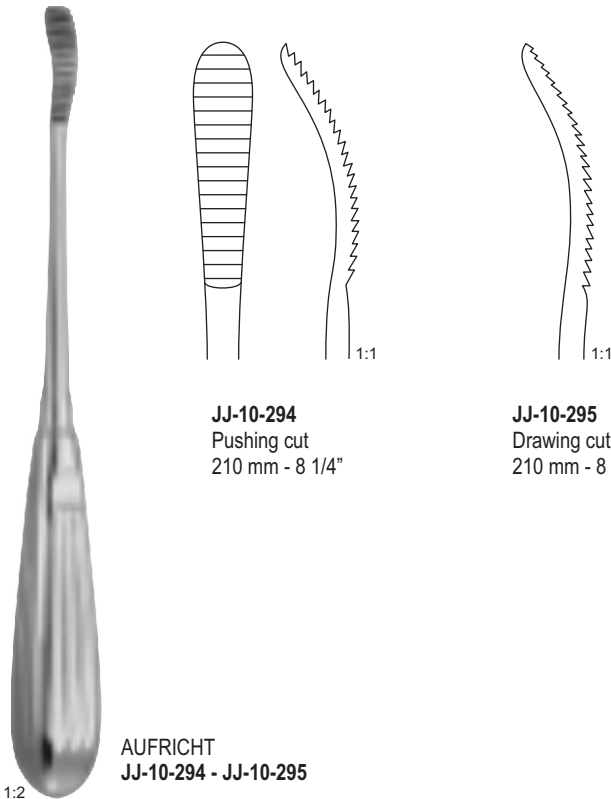

1:2

AUFRICHT
JJ-10-294 - JJ-10-295

JJ-10-294
Pushing cut
210 mm - 8 1/4"

JJ-10-295
Drawing cut
210 mm - 8 1/4"

RASPS WITHOUT TUNGSTEN CARBIDE



JJ-10-296 - 205
200 mm - 8"



FOMON
Teeth

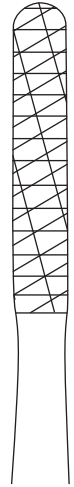

JJ-10-296
Fig.1
12

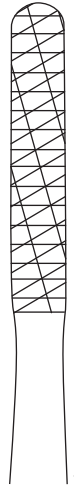

JJ-10-297
Fig.3
16

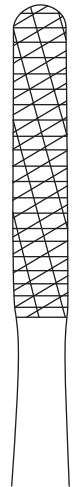

JJ-10-298
Fig.5
24



JJ-10-299
Fig.7
36



JJ-10-300
Fig.9
52



FOMON TC
Teeth

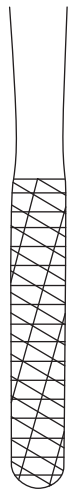

JJ-10-301
Fig.2
14



JJ-10-302
Fig.4
20



JJ-10-303
Fig.6
30

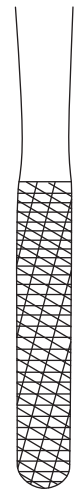

JJ-10-304
Fig.8
44



JJ-10-305
Fig.10
62



JJ-10-306 - JJ-10-308



1:2
JJ-10-306
Straight

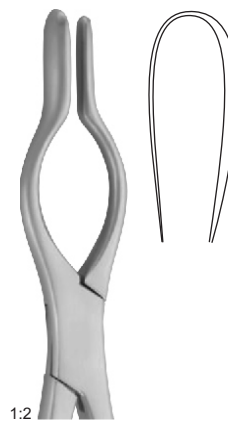

1:2
JJ-10-307
Left

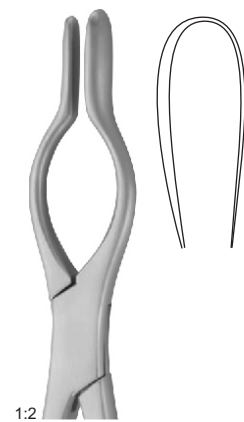

1:2
JJ-10-308
Right

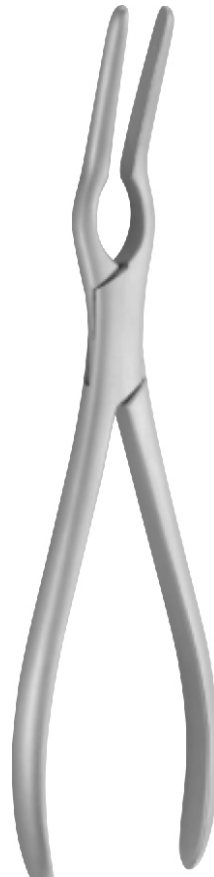

1:2
ASCH
JJ-10-309
230 mm - 9"

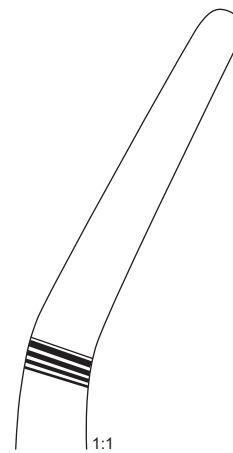

1:1

SEPTUM FORCEPS AND SCISSOR

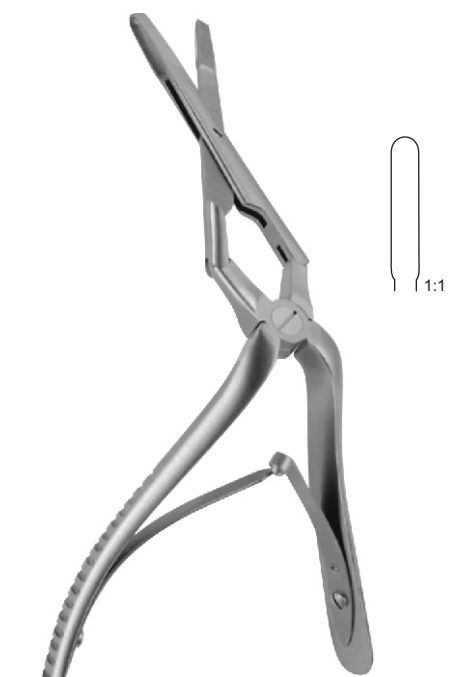

1:2 MIDDLETON - JANSEN
JJ-10-310
190 mm - 7½"

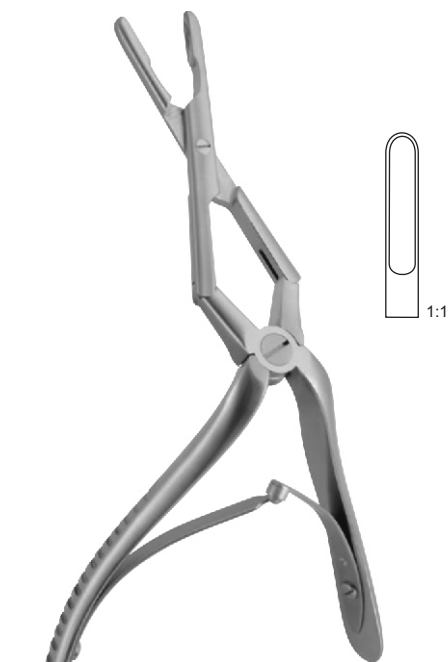

1:2 MIDDLETON - JANSEN
JJ-10-311
190mm - 7½"

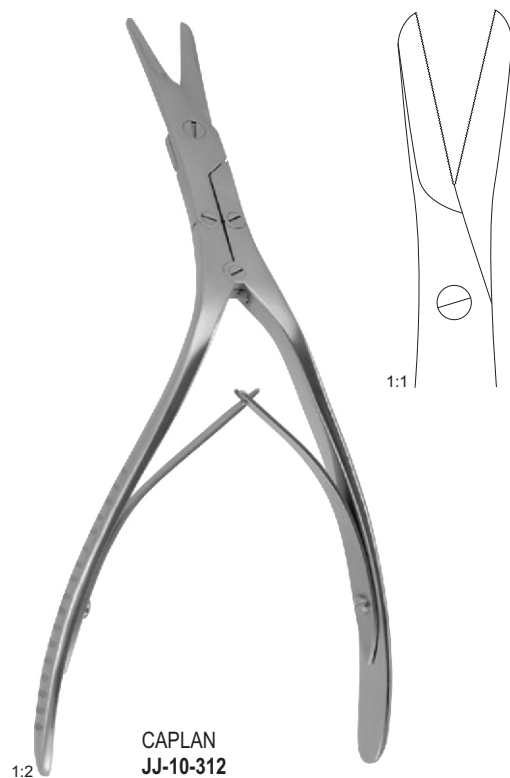

1:2 CAPLAN
JJ-10-312
toothed
200 mm - 8"

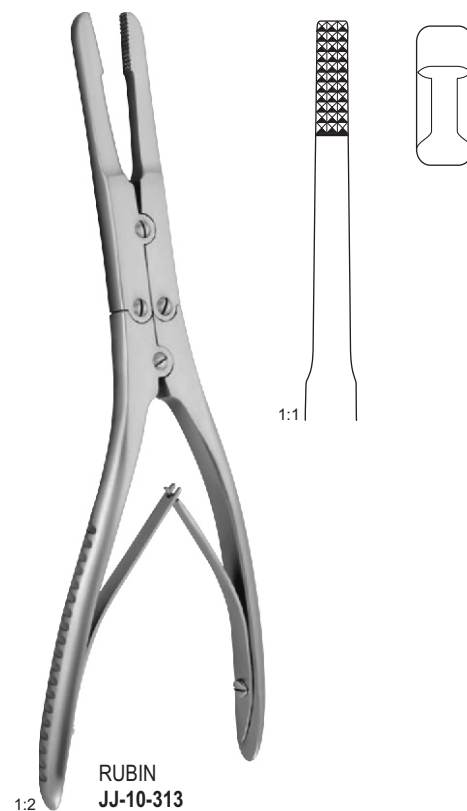

1:2 RUBIN
JJ-10-313
protection cap
210 mm - 8 1/4"

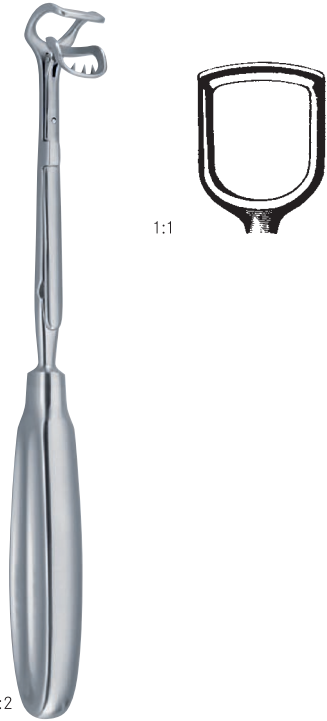

1:2
ST. CLAIR-THOMSON
JJ-10-314
210 mm - 8 1/4"

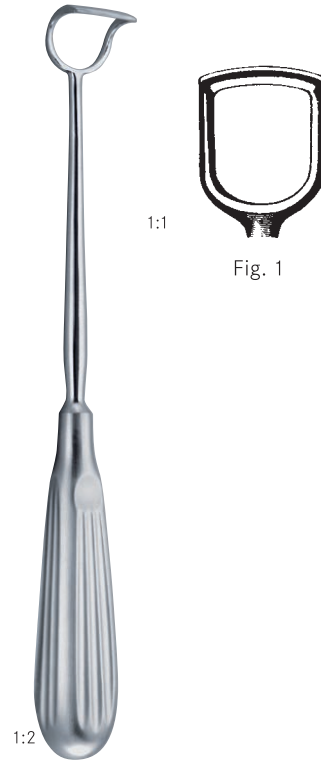

1:2
BARNHILL
JJ-10-315
220 mm - 8 3/4"



BECKMANN
JJ-10-316
Straight Curved
220 mm - 8 3/4"

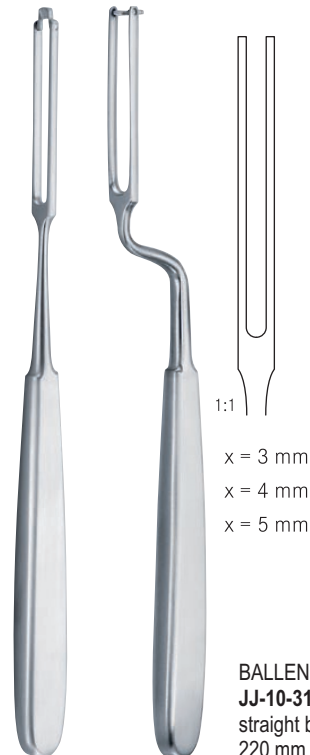

1:1
x = 3 mm
x = 4 mm
x = 5 mm
BALLENGER
JJ-10-317
straight bayonet
220 mm - 8"

MOUTH GAGS



1:2

**MOLT
JJ-10-318**
for children
110 mm - 4 1/4"



1:2

**MOLT
JJ-10-319**
for adults
140 mm - 5 1/2"



1:2

**DENHART
JJ-10-320**
120 mm - 4 3/4"



1:2

**FERGUSON - ACKLAND
JJ-10-321**
145 mm - 5 3/4"



**ROSER - KÖNIG
JJ-10-322**
160 mm - 6 1/4"
190 mm - 7 1/2"



JJ-10-323 - JJ-10-333

JJ-10-33	Fig. 00	8 mm	∅
JJ-10-324	Fig. 0	10 mm	∅
JJ-10-325	Fig. 1	12 mm	∅
JJ-10-326	Fig. 2	14 mm	∅
JJ-10-327	Fig. 3	16 mm	∅
JJ-10-328	Fig. 4	18 mm	∅
JJ-10-329	Fig. 5	20 mm	∅
JJ-10-330	Fig. 6	22 mm	∅
JJ-10-331	Fig. 7	24 mm	∅
JJ-10-332	Fig. 8	26 mm	∅
JJ-10-333	Fig. 9	28 mm	∅
JJ-10-333	Fig. 10	30 mm	∅



1:2

JJ-10-334
100 mm - 4"



JJ-10-335 - JJ-10-346

JJ-10-335	Fig. 00	8 mm	∅
JJ-10-336	Fig. 0	10 mm	∅
JJ-10-337	Fig. 1	12 mm	∅
JJ-10-338	Fig. 2	14 mm	∅
JJ-10-339	Fig. 3	16 mm	∅
JJ-10-340	Fig. 4	18 mm	∅
JJ-10-341	Fig. 5	20 mm	∅
JJ-10-342	Fig. 6	22 mm	∅
JJ-10-343	Fig. 7	24 mm	∅
JJ-10-344	Fig. 8	26 mm	∅
JJ-10-345	Fig. 9	28 mm	∅
JJ-10-346	Fig. 10	30 mm	∅



JJ-10-347	10 mm	∅
JJ-10-348	12 mm	∅
JJ-10-349	14 mm	∅
JJ-10-350	16 mm	∅
JJ-10-351	18 mm	∅

MICHEL
JJ-10-347 - JJ-10-351
moveable mirror
250 mm - 9 3/4"

TONSIL SNARES

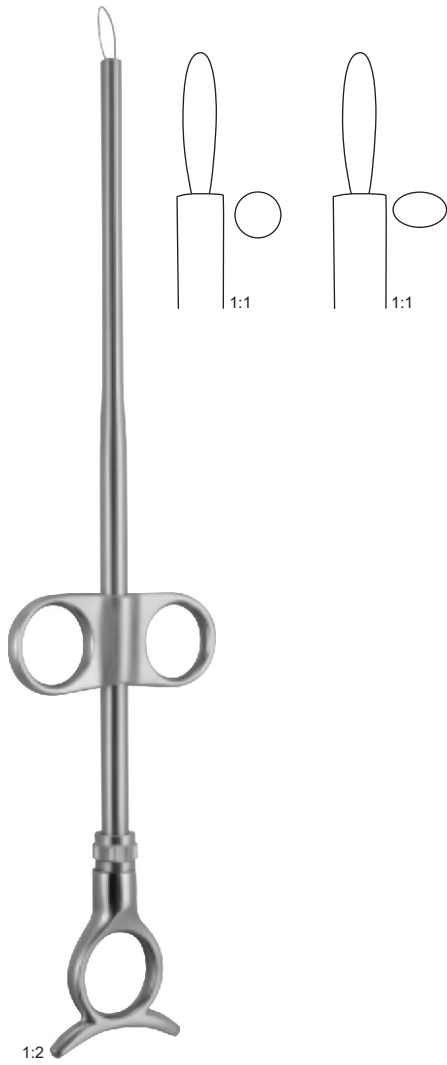

EVES
JJ-10-352
 280 mm - 11"



EVES
JJ-10-353
 280 mm - 11"



BRUENINGS
JJ-10-354
 280 mm - 11"



JJ-10-355
 10 mm - 33 ft.
 0.3 mm Ø
 0.4 mm Ø

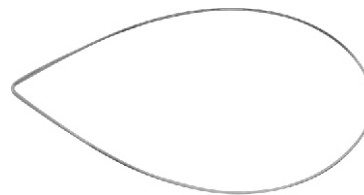

JJ-10-356
 Package of 100 pieces
 40 mm
 50 mm



1:2
COLVER
JJ-10-357
straight curved
190 mm - 7½"



1:2
WHITE
JJ-10-358
180 mm - 7"
230 mm - 9"

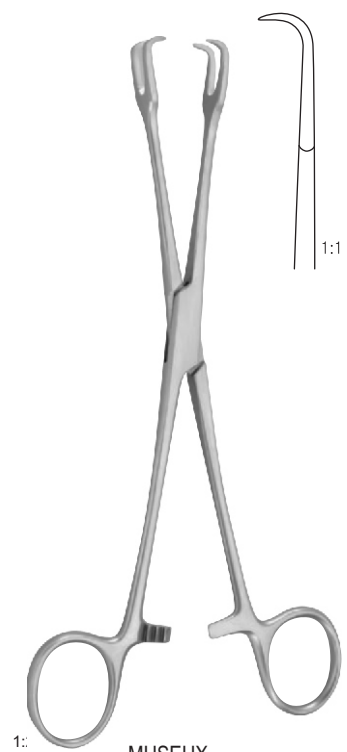

1:1
MUSEUX
JJ-10-359
tonsil holding forceps
200 mm - 8"



1:2
JACKSON
JJ-10-360
laryngeal forceps
220 mm - 8½"

TRACHEA DILATOR

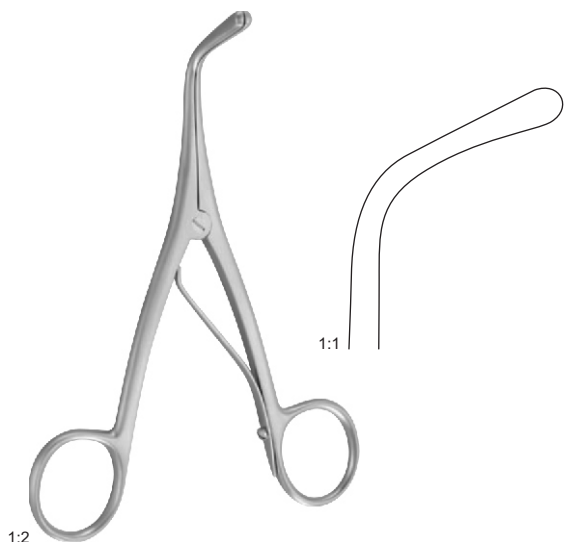

1:2
TROUSSEAU
JJ-10-361
140 mm - 5½"

BRONCHO - OESOPHAGOSCOPY FORCEPS

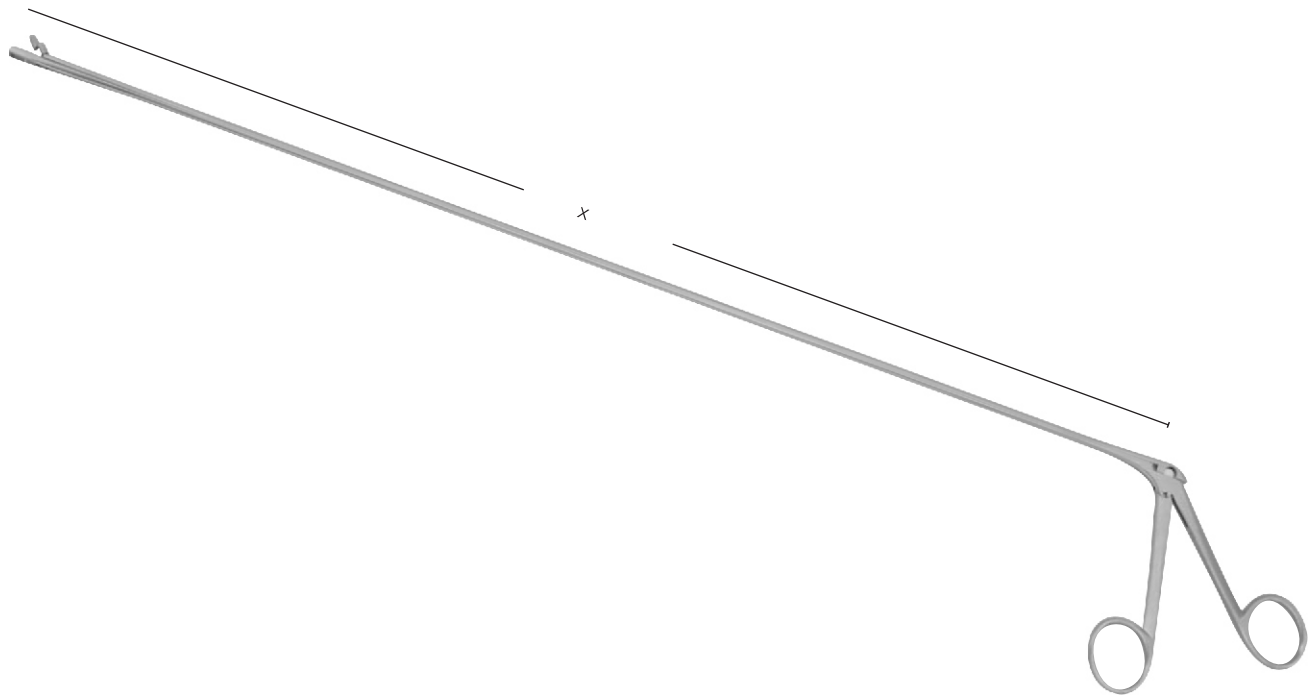

JJ-10-362



JJ-10-363



JJ-10-364



JJ-10-365

CHEVALIER - JACKSON
JJ-10-32 - JJ-10-368
X = 300 mm - 12"
X = 400 mm - 16"
X = 500 mm - 20"
X = 600 mm - 23½"



JJ-10-366



JJ-10-367



JJ-10-368

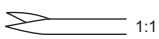
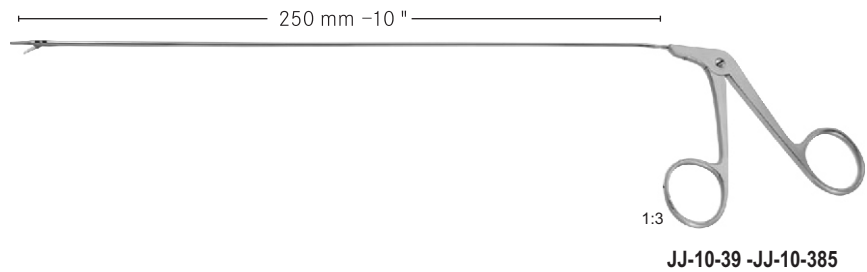

JJ-10-369
Straight



JJ-10-370
Straight horizontal



JJ-10-371
Angled up horizontal

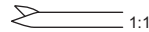

JJ-10-372
Curved right

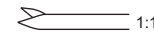

JJ-10-373
Curved left



JJ-10-374
Angled up



JJ-10-375
Straight, serrated



JJ-10-376
Straight horizontal



JJ-10-377
Angled up horizontal



JJ-10-378
Curved right



JJ-10-379
Curved left



JJ-10-380
Straight



JJ-10-381
Angled up
0.25 mm



JJ-10-382
Angled up horizontal



JJ-10-383
Curved right



JJ-10-384
Curved left

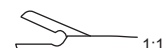

JJ-10-385
Oval
0.35 mm



DAVIS-BOYLE
JJ-10-386 - JJ-10-388
 complete, consisting of frame
 and 5 tongue depressors no. 1-5

JJ-10-386
 Frame for Mouth Gag

JJ-10-387
 14.5 cm
 Frame for Mouth Gag with joint

JJ-10-388
 14.5 cm
 Silicone inlay



Fig. 1
JJ-10-389 - JJ-10-392
 110 X 28 mm



Fig. 2
JJ-10-389
 95 X 27 mm



Fig. 3
JJ-10-390
 80 X 27 mm



Fig. 4
JJ-10-391
 65 X 26 mm



Fig. 5
JJ-10-392
 without suction tube
 30 X 20 mm



NEUKAM
JJ-10-393 - 297
complete, with frame
and 3 tongue depressors

NEUKAM
JJ-10-393
Frame for Mouth Gag, only



JJ-10-394
Tongue Depressor
fenestrated blade for suction

1/2
Fig. 1
JJ-10-395

Fig. 2
JJ-10-396

Fig. 3
JJ-10-397



KILNER-DOUGHTY
JJ-10-38 - JJ-10-304
complete, with frame, 3 tongue depressors,
2 toothplates and 1 palate plate



JJ-10-399
Palate plate

KILNER-DOUGHTY
JJ-10-400
14.5 cm
Frame for Mouth Gag

KILNER-DOUGHTY
JJ-10-401
Tongue Depressor
fenestrated blade for suction

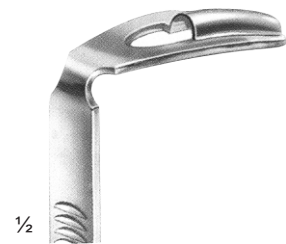

1/2
Fig. 1
JJ-10-402
68 X 30 mm

Fig. 2
JJ-10-403
77 X 34 mm

Fig. 3
JJ-10-404
82 X 39 mm

MOUTH GAGS

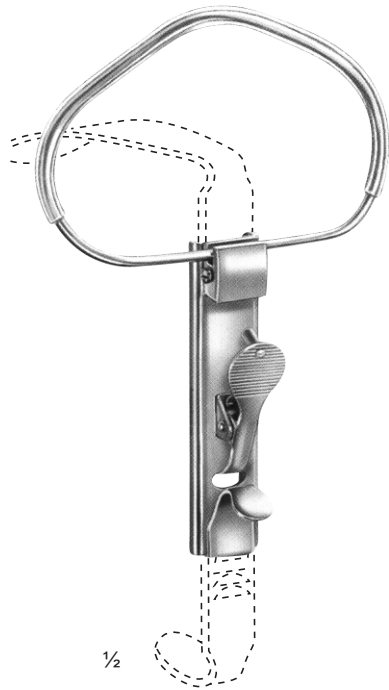

MCLVOR
JJ-10-405 - 309
complete, with 3 tongue depressors

MCLVOR
JJ-10-405
Frame for Mouth Gag

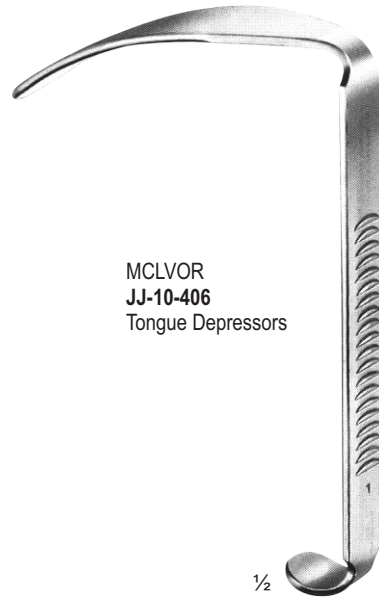

MCLVOR
JJ-10-406
Tongue Depressors

Fig. 1
JJ-10-407
100 X 25 mm

Fig. 2
JJ-10-408
85 X 25 mm

Fig. 3
JJ-10-409
75 X 25 mm

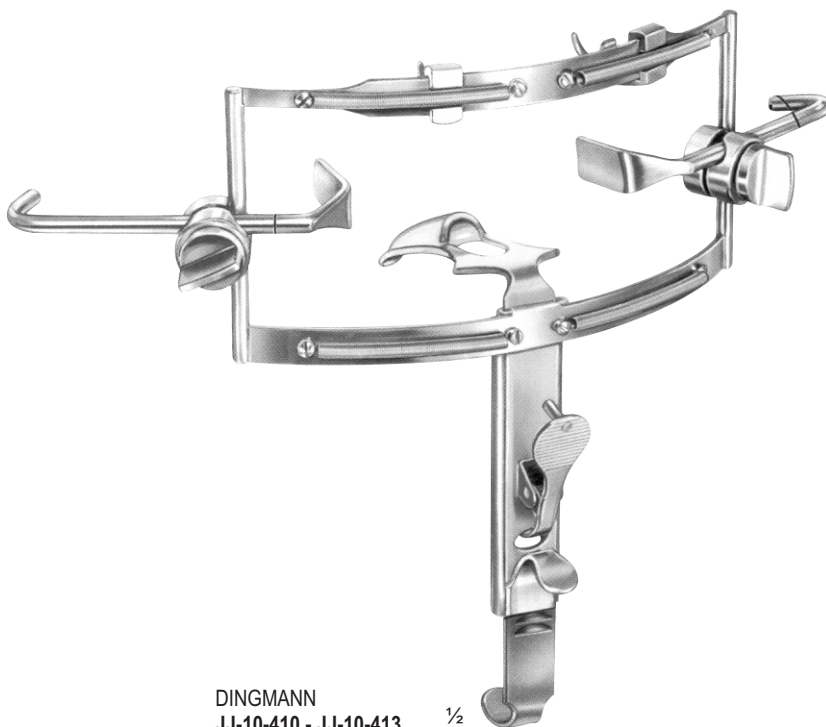

DINGMANN
JJ-10-410 - JJ-10-413
complete, with frame, 3 tongue depressors,
and 2 adjustable lateral blades

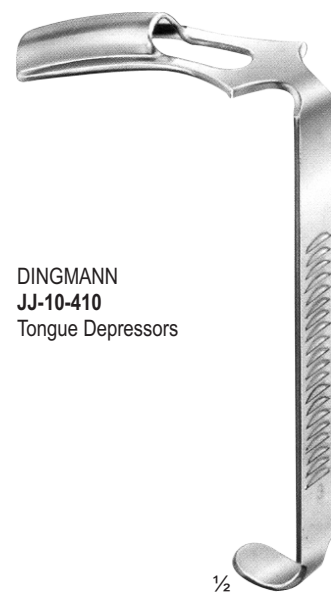

DINGMANN
JJ-10-410
Tongue Depressors

Fig. 1
JJ-10-4 11
62 X 26 mm

Fig. 2
JJ-10-412
65 X 30 mm

Fig. 3
JJ-10-413
78 X 32 mm



NEGUS
JJ-10-414 - JJ-10-417
complete
handle



1:2
JJ-10-414
Fig.1
20 mm X 70 mm



1:2
JJ-10-415
Fig.2
30 mm X 80 mm



1:2
JJ-10-416
Fig.3
33 mm X 95 mm



1:2
JJ-10-417
Handle

TONSIL INSTRUMENTS

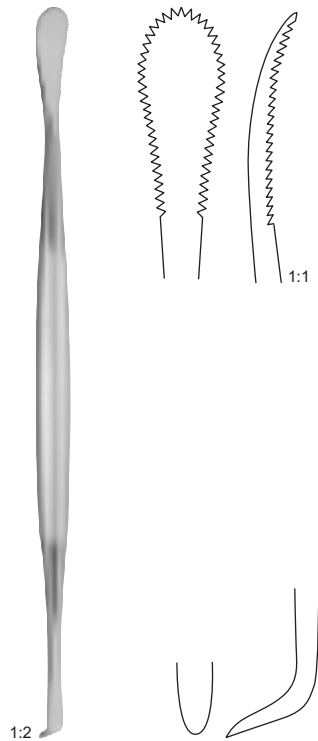

1:2
HENKE
JJ-10-418
tonsil dissector
230 mm - 9"

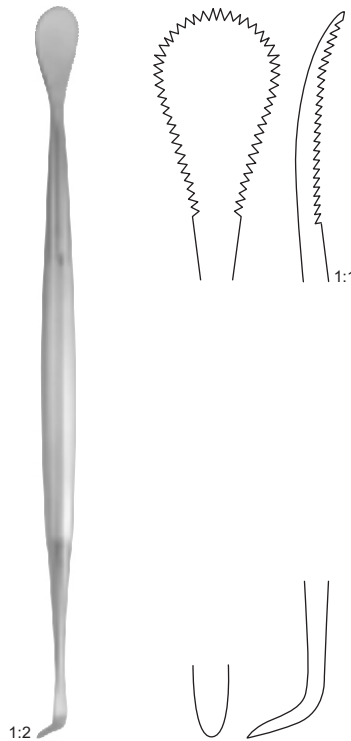

1:2
HENKE
JJ-10-419
tonsil dissector
230 mm - 9"

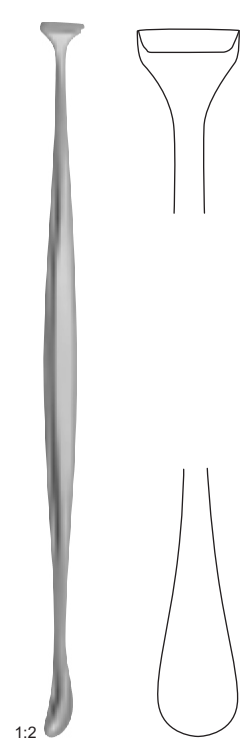

1:2
HURD
JJ-10-420
tonsil dissector
225 mm - 8 3/4"

MOUTH GAGS, LIP AND CHEEK RETRACTORS



JENNINGS
JJ-10-421 - JJ-10-424
JJ-10-421 10.5 cm
JJ-10-422 12.5 cm
JJ-10-423 14.5 cm
JJ-10-424 16.5 cm

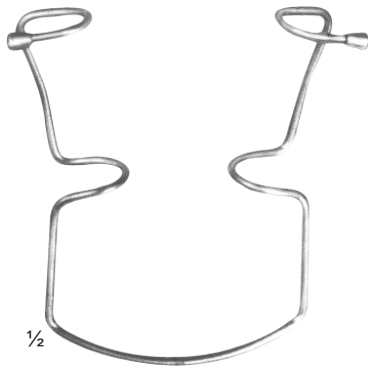

ORINGER
JJ-10-425 - JJ-10-427
9.5 cm
self retaining, for children

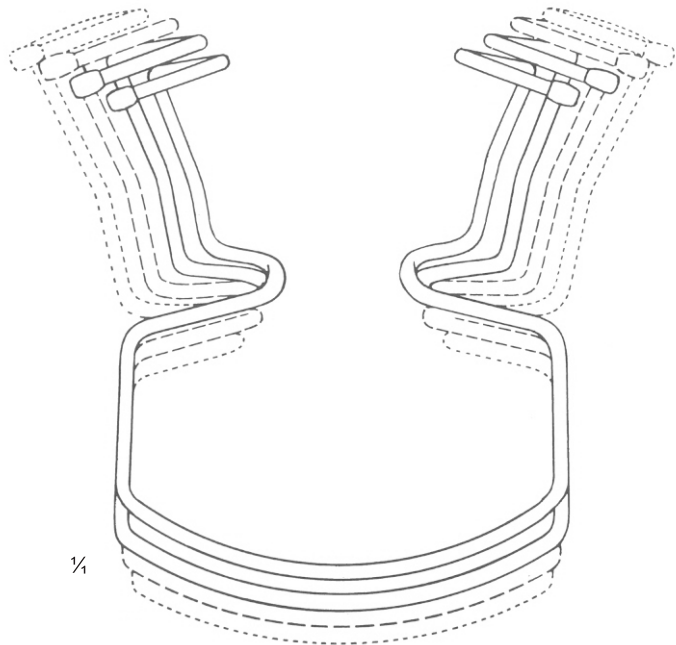
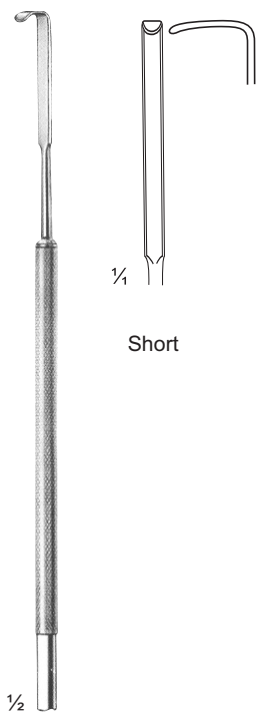

Fig. 1
JJ-10-425
10 cm

Fig. 2
JJ-10-426
10.5 cm

Fig. 3
JJ-10-427
11 cm



Short

SALYER
JJ-10-428
185 mm
Cleft Palate
Hooklets

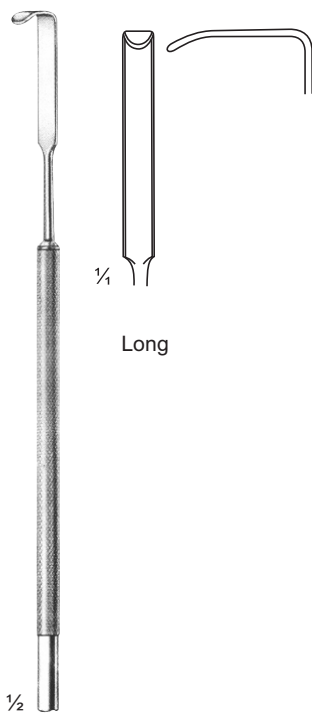

Long

SALYER
JJ-10-429
185 mm
Cleft Palate
Hooklet

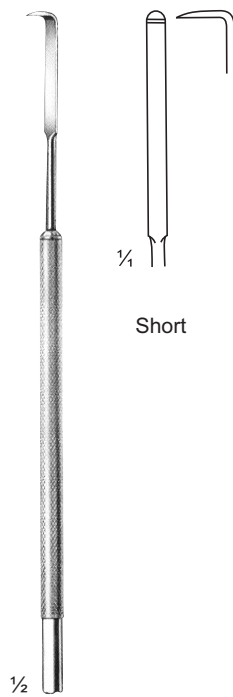

Short

SALYER
JJ-10-430
180 mm
Cleft Palate
Dissector

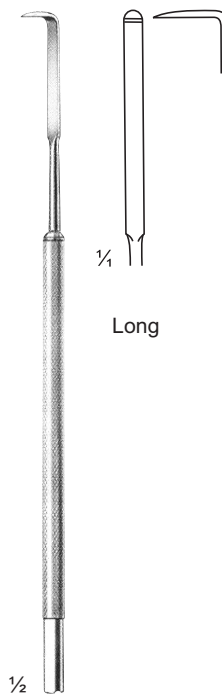

Long

SALYER
JJ-10-431
180 mm
Cleft Palate
Dissector

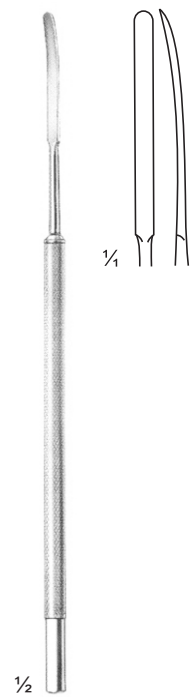

SALYER
JJ-10-432
180 mm
Cleft Palate
Instruments

EXCHANGEABLE TIPS

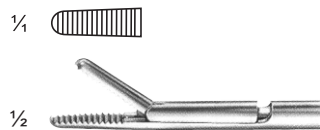

FRAENKEL
JJ-10-433
 for interchangeable tubes

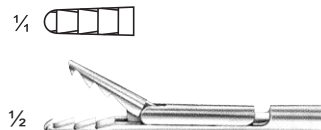

SEIFFERT
JJ-10-434
 for interchangeable tubes

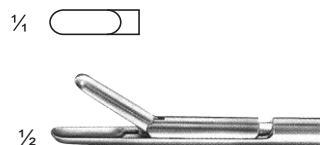

FRAENKEL
JJ-10-435
 for interchangeable tubes

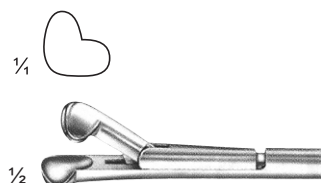

SCHEINMANN
JJ-10-436
 for interchangeable tubes

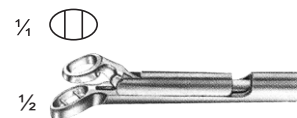

SCHEINMANN
JJ-10-437
 for interchangeable tubes

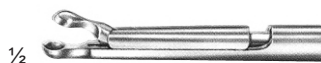

BRÜNINGS
JJ-10-438 - JJ-10-439
 for interchangeable tubes

Fig. 2
JJ-10-438

Fig. 3
JJ-10-439

Fig. 2
JJ-10-440

Fig. 3
JJ-10-441



BRÜNINGS
JJ-10-440 - JJ-10-441
 for interchangeable tubes



LANGE
JJ-10-442
 for interchangeable tubes

Fig. 1
JJ-10-442



Fig. 1
JJ-10-443



Fig. 2
JJ-10-444



KRAUSE
JJ-10-443 - JJ-10-444
for interchangeable tubes

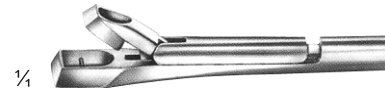

KRAUSE
JJ-10-445
for interchangeable tubes



Fig. 1
JJ-10-446



Fig. 2
JJ-10-447



Fig. 3
JJ-10-448



Fig. 4
JJ-10-449



CORDES
JJ-10-446 - JJ-10-449
for interchangeable tubes



SCHUMACHER
JJ-10-450
for interchangeable tubes



Fig. 1
JJ-10-451



Fig. 2
JJ-10-452



CORDES
JJ-10-41 - JJ-10-452
for interchangeable tubes



CORDES
JJ-10-453
for interchangeable tubes



ROSENBERG
JJ-10-454
for interchangeable tubes

Page 223–241

- Elevators
- Bone Levers
- Raspatories
- Bone Files
- Bone Curettes

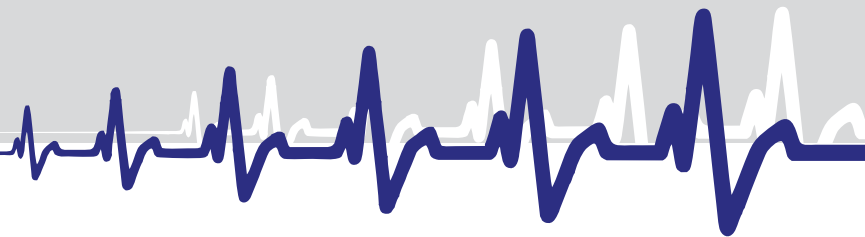

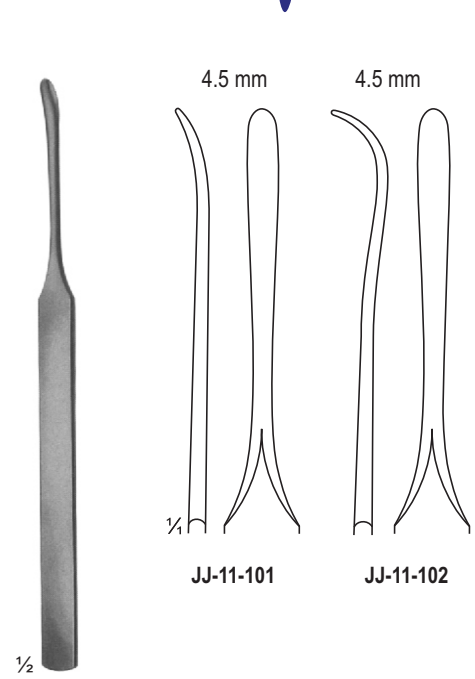

JJ-11-101 - JJ-11-102
KONIG
155 mm

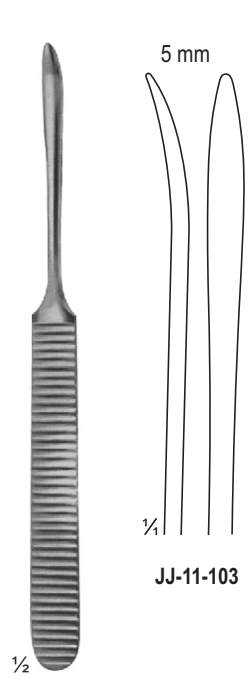

RS-003
WILLIGER
165 mm

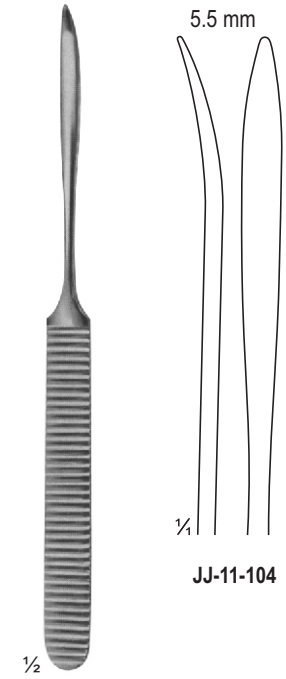

JJ-11-104
WILLIGER
170 mm

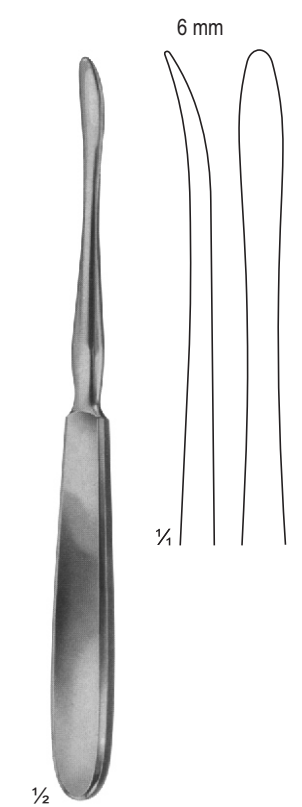

JJ-11-105
QUERVAIN
195 mm

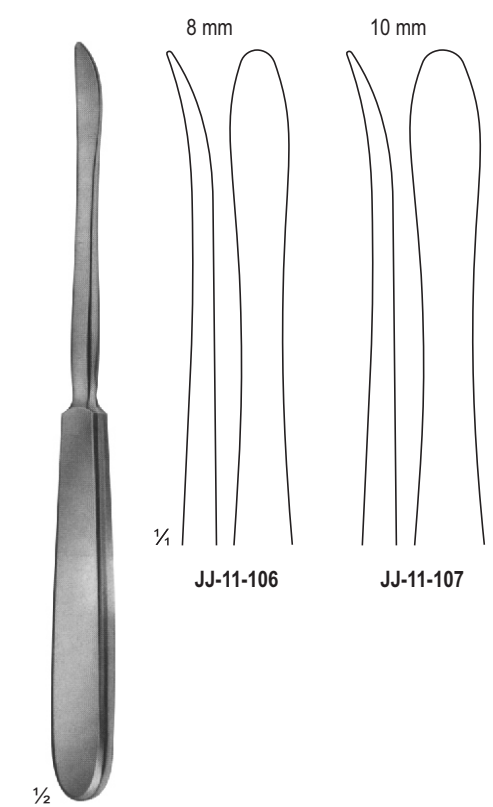

JJ-11-106 - JJ-11-107
LANGENBECK
195 mm

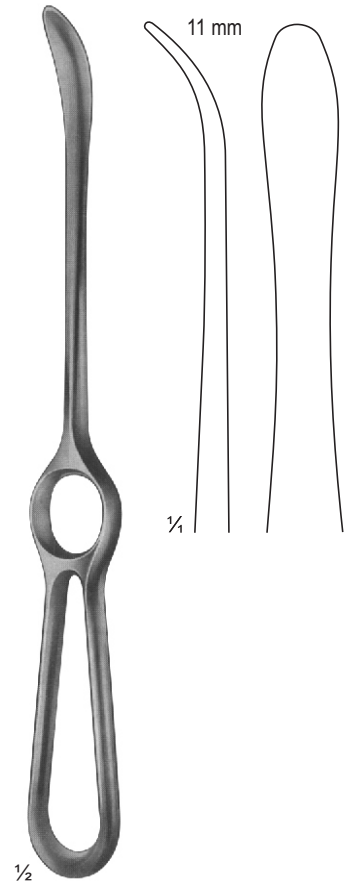

JJ-11-108
LANGENBECK
230mm

BONE LEVERS

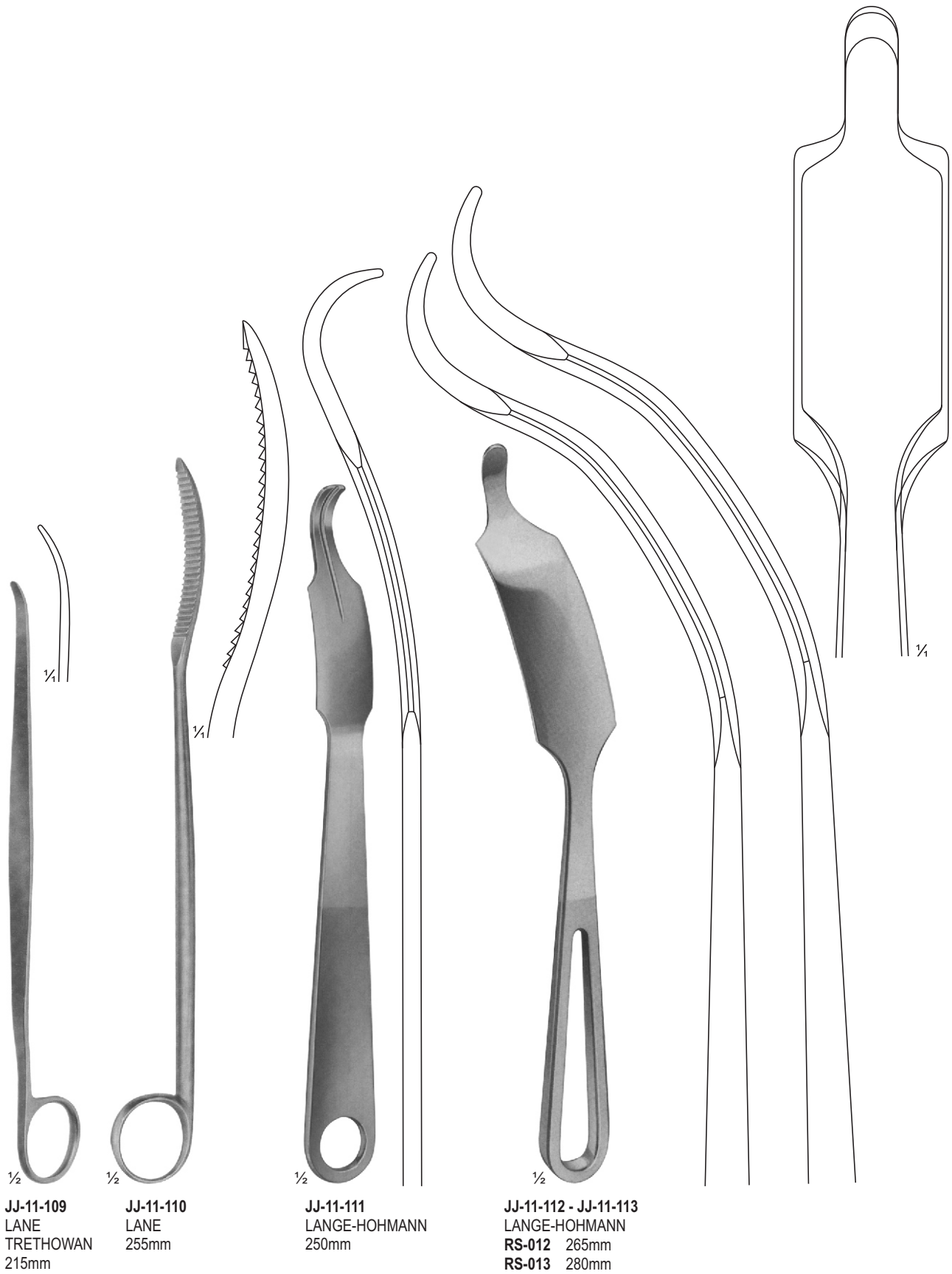

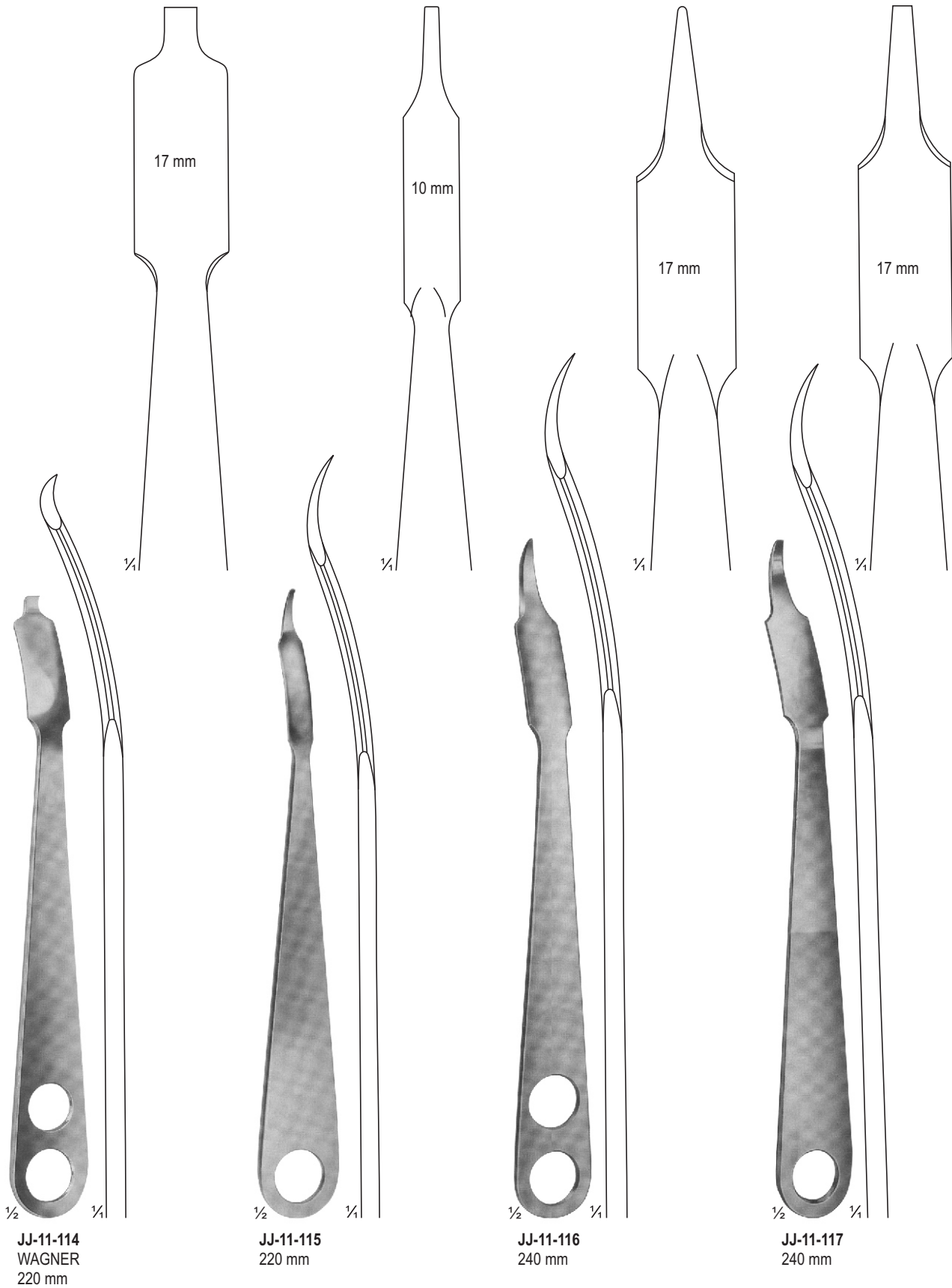

BONE LEVERS

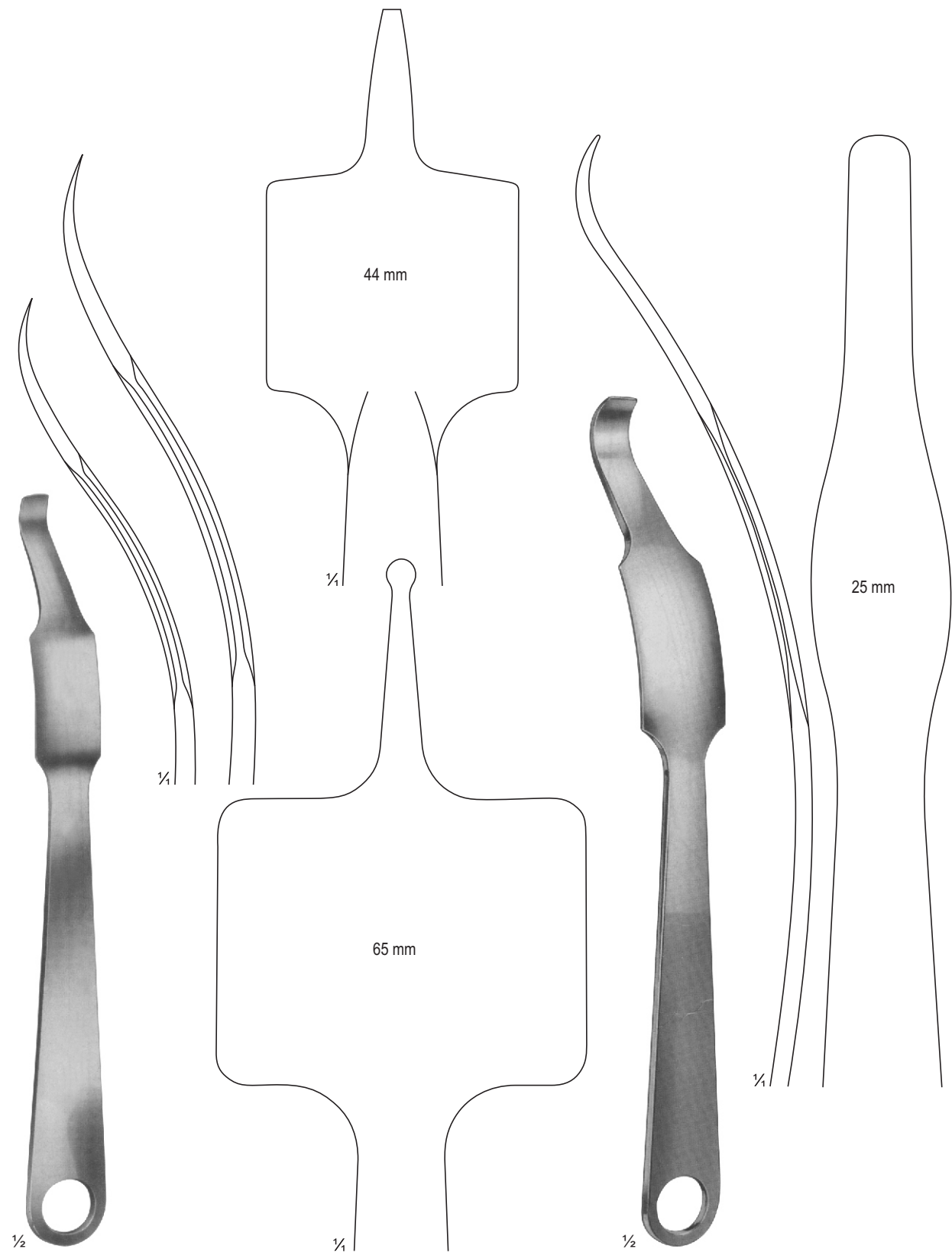

JJ-11-118 - JJ-11-119
VERBRUGGE-MULLER
JJ-11-118 240 mm
JJ-11-119 255 mm

JJ-11-120
260 mm

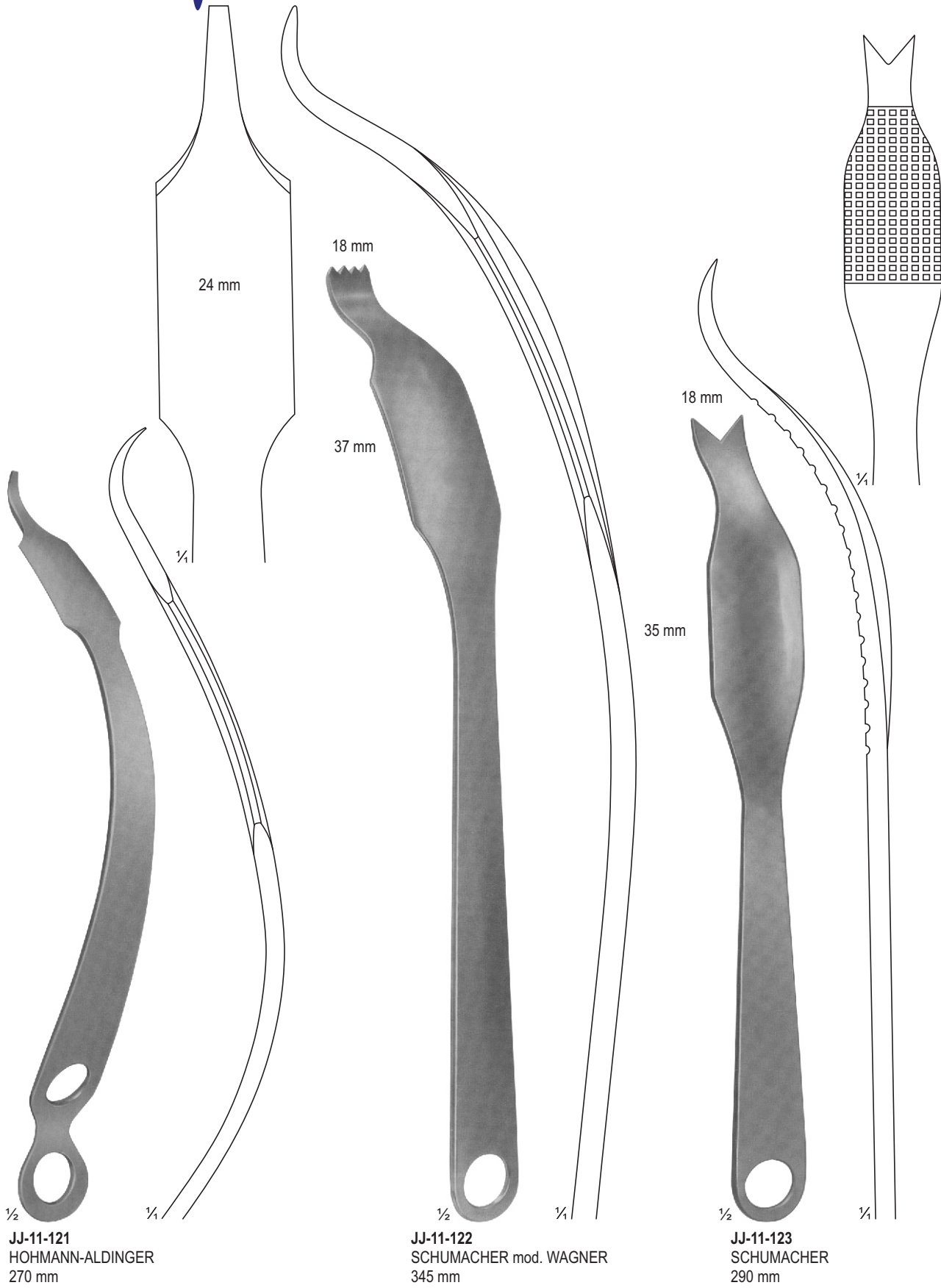

BONE LEVERS

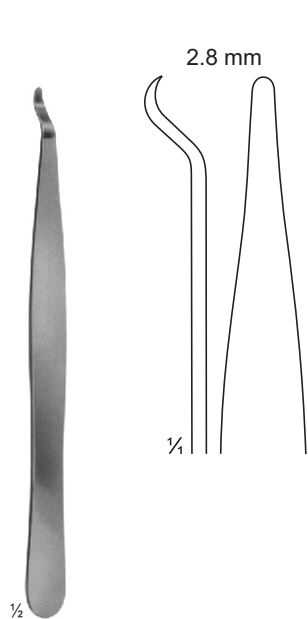

JJ-11-124
140 mm

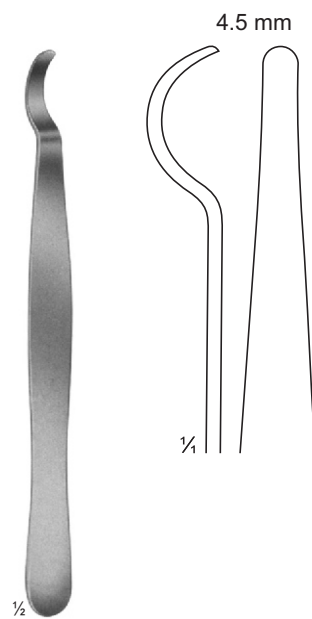

JJ-11-125
150 mm

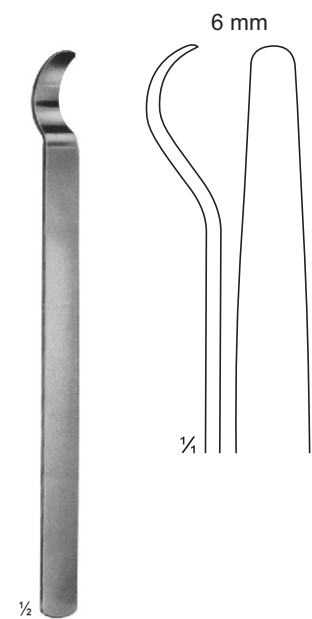

JJ-11-126
150 mm

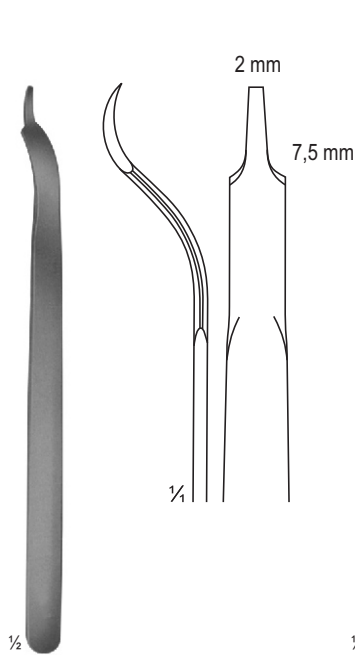

BUCK-GRAMCKO
JJ-11-127
150 mm

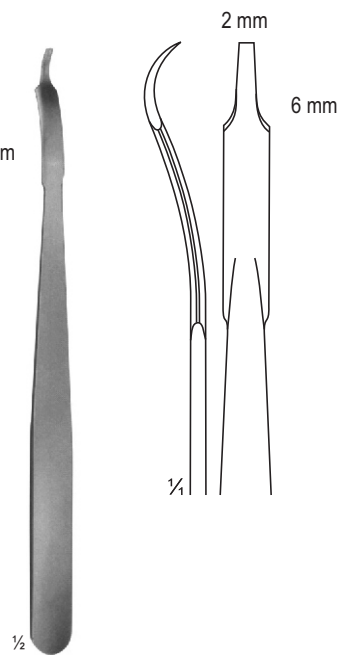

JJ-11-128
160 mm

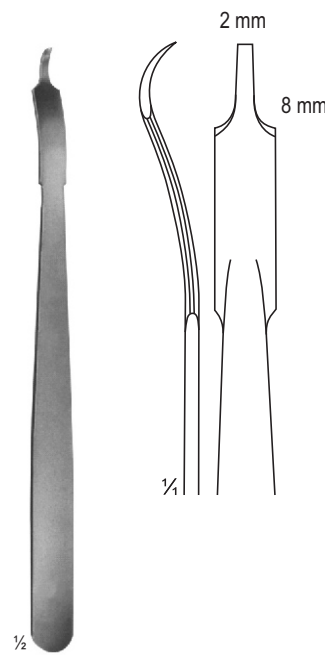

JJ-11-129
160 mm

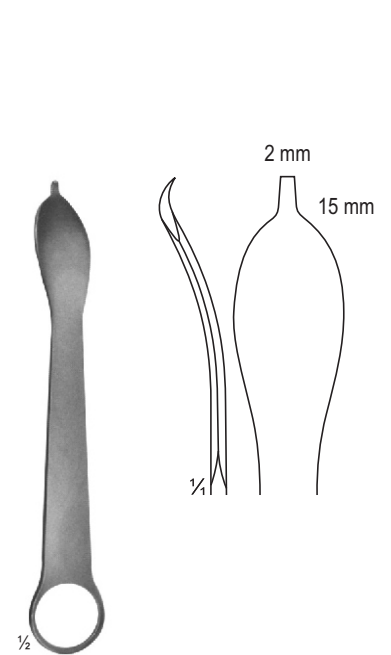

JJ-11-130
125 mm

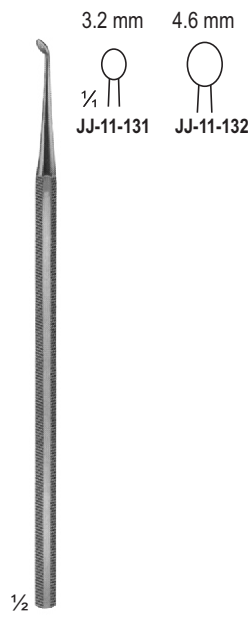

JJ-11-131 - JJ-11-132
PARTSCH
150 mm

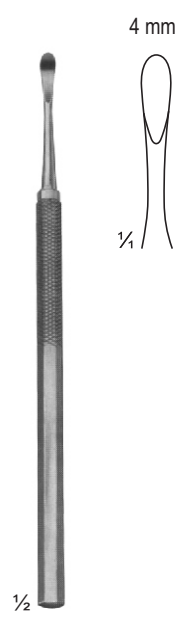

JJ-11-133
PARTSCH mod. LANGE
145 mm

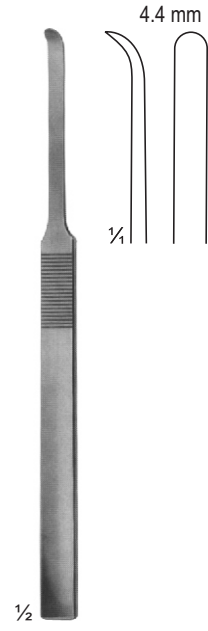

JJ-11-134
MC KENTY
155 mm

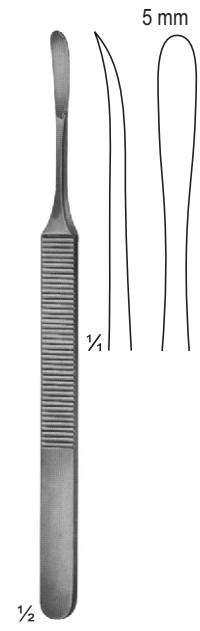

JJ-11-135
KONIG
155 mm

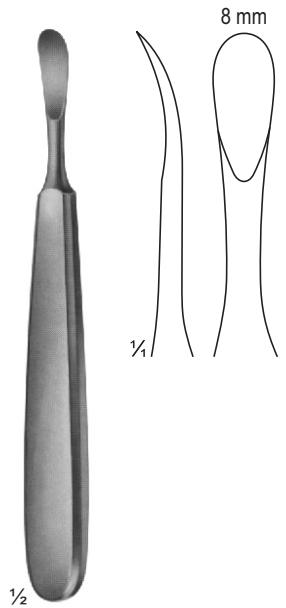

JJ-11-136
TRELAT
150 mm

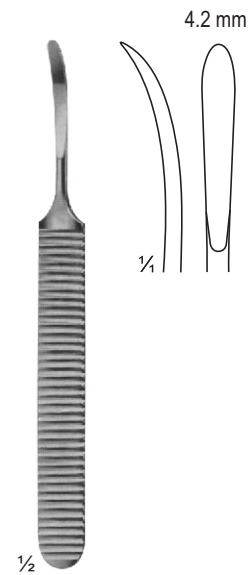

JJ-11-137
WILLIGER
140 mm

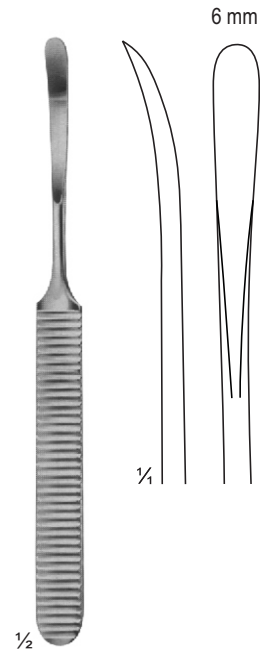

JJ-11-138
WILLIGER
160 mm

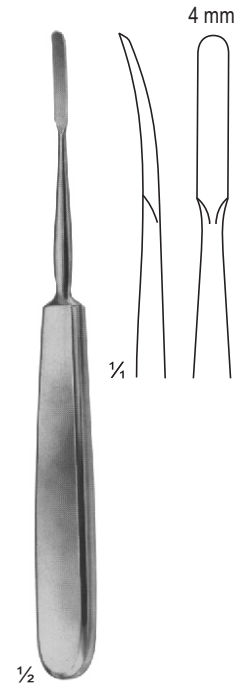

JJ-11-139
JOSEPH
170 mm

RASPATORIES

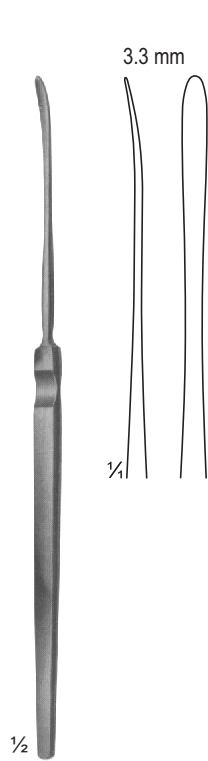

JJ-11-140
HALLE
stumpf/blunt
180 mm

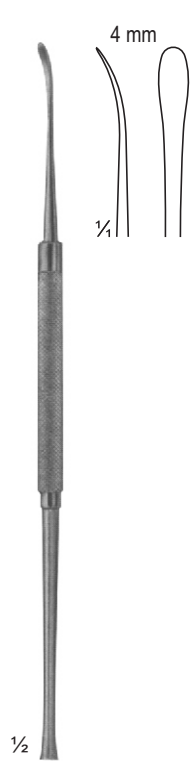

JJ-11-141
FREER
stumpf/blunt
190 mm

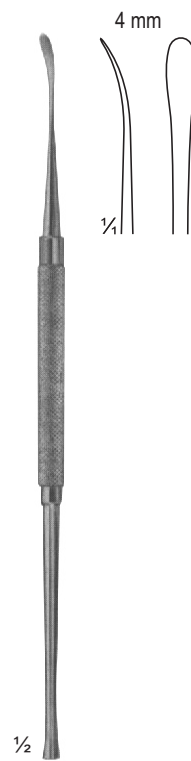

JJ-11-142
FREER
stumpf/sharp
190 mm

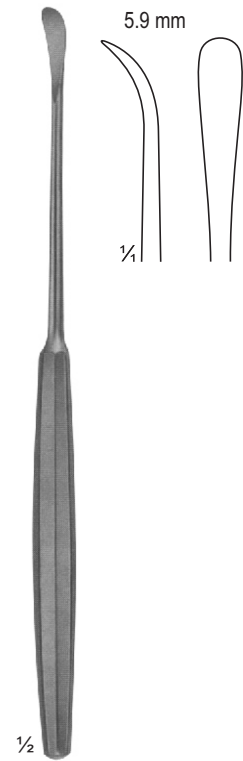

JJ-11-143
SEWALL
stumpf/blunt
190 mm

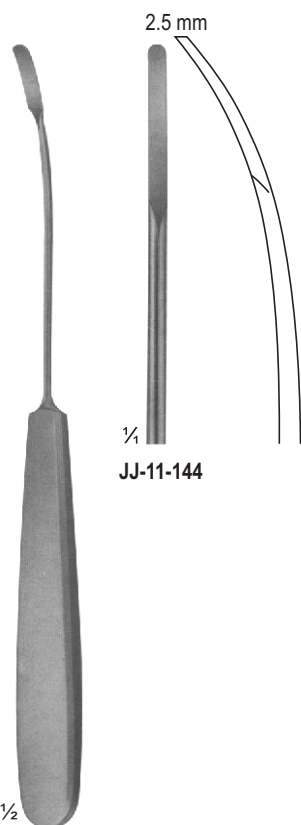

JJ-11-144

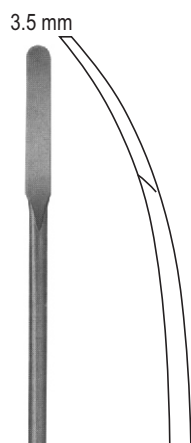

JJ-11-145

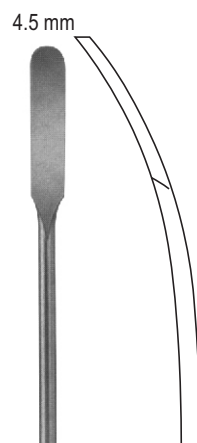

JJ-11-146



JJ-11-147

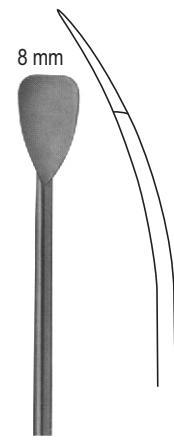

JJ-11-148

JJ-11-144 - JJ-11-146
205 mm

JJ-11-147 - JJ-11-148
PAULSEN
205 mm

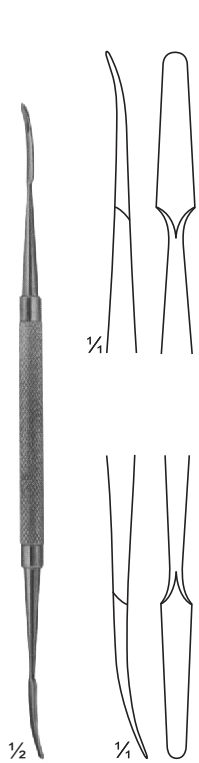

JJ-11-149
KILLIAN
sharp/blunt
185 mm

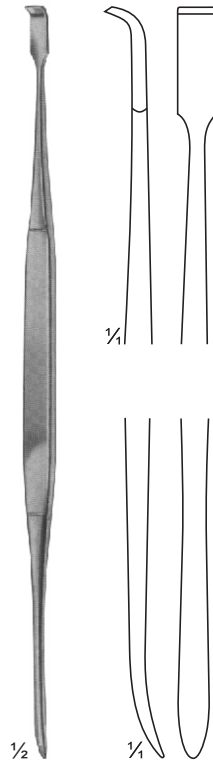

JJ-11-150
HOWARTH
sharp/blunt
215 mm

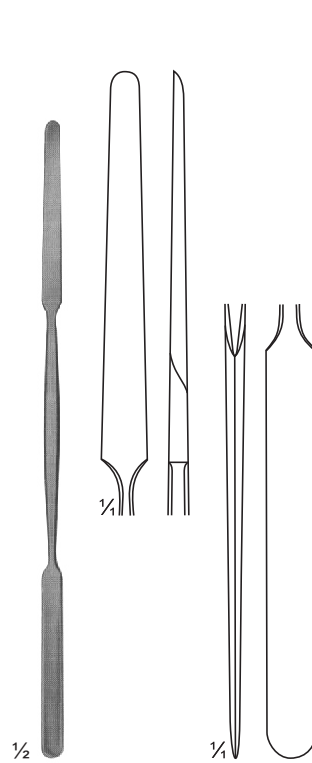

JJ-11-151
KILLIAN
sharp/blunt
185 mm

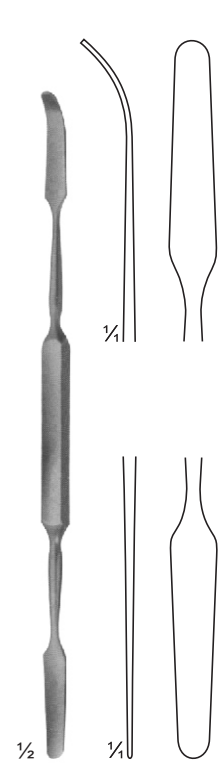

JJ-11-152
MAC DONALD
blunt/blunt
185 mm

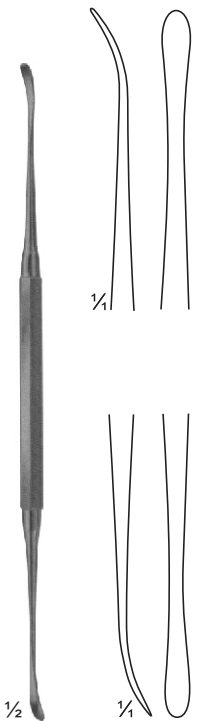

JJ-11-153
FREER
sharp/blunt
185 mm

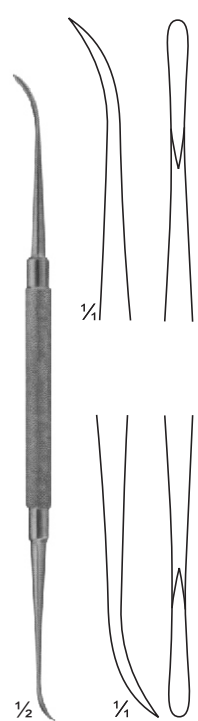

JJ-11-154
FREER-YASARGIL
sharp/sharp
185 mm

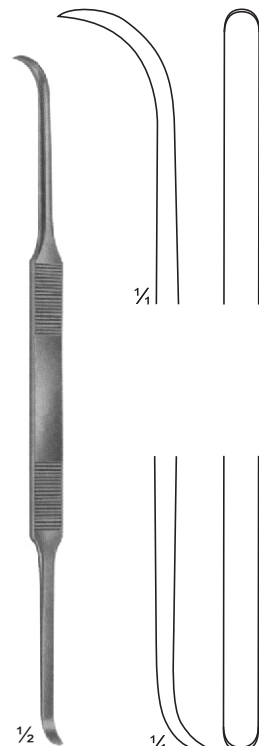

JJ-11-155
COTTLE
sharp/sharp
200 mm

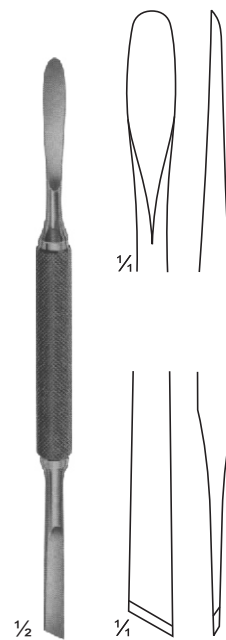

JJ-11-156
MEAD
sharp/sharp
165 mm

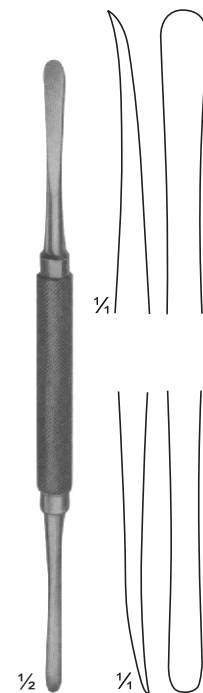

JJ-11-157
MOLT
sharp/sharp
180 mm

RASPATORIES

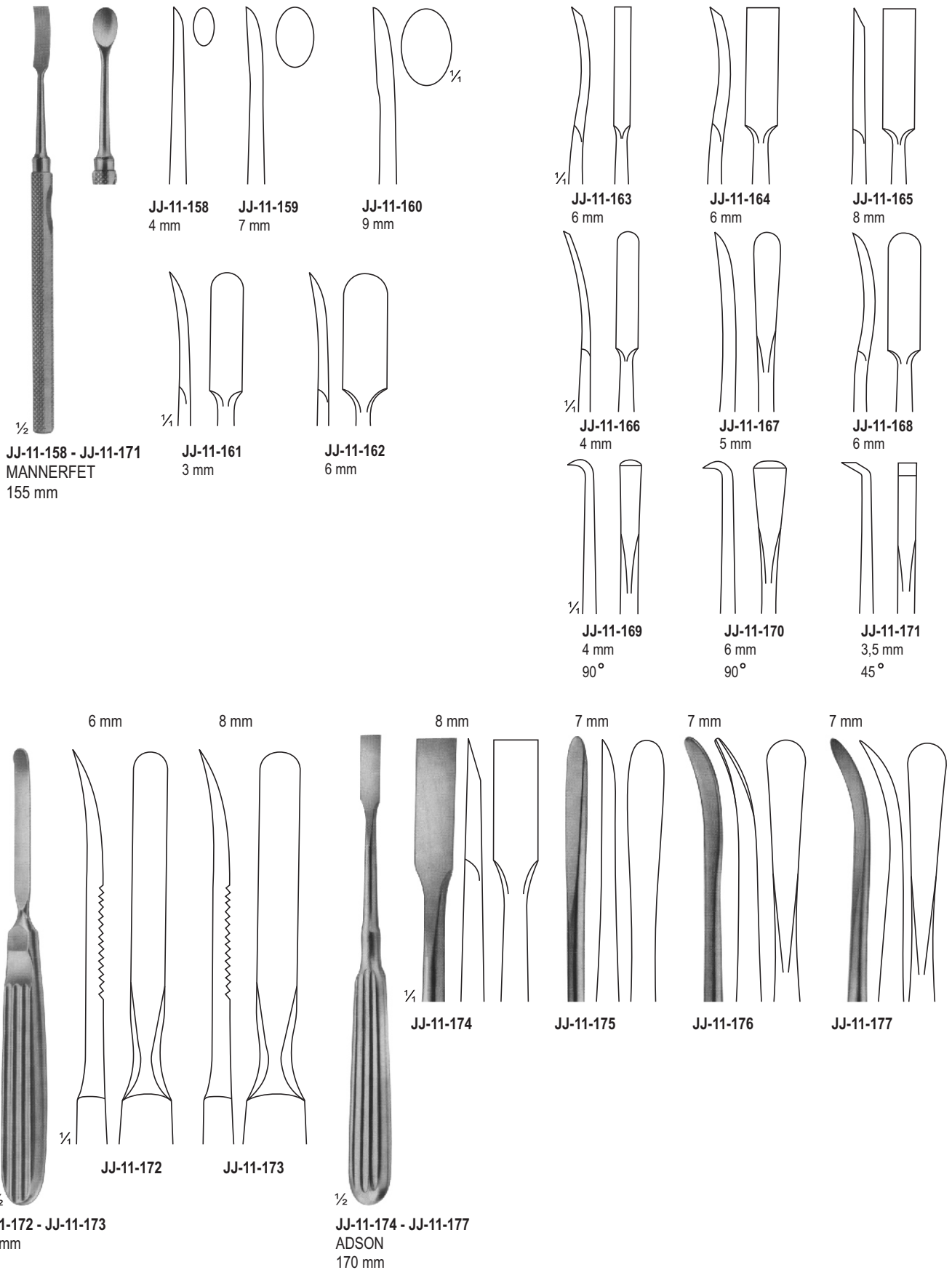

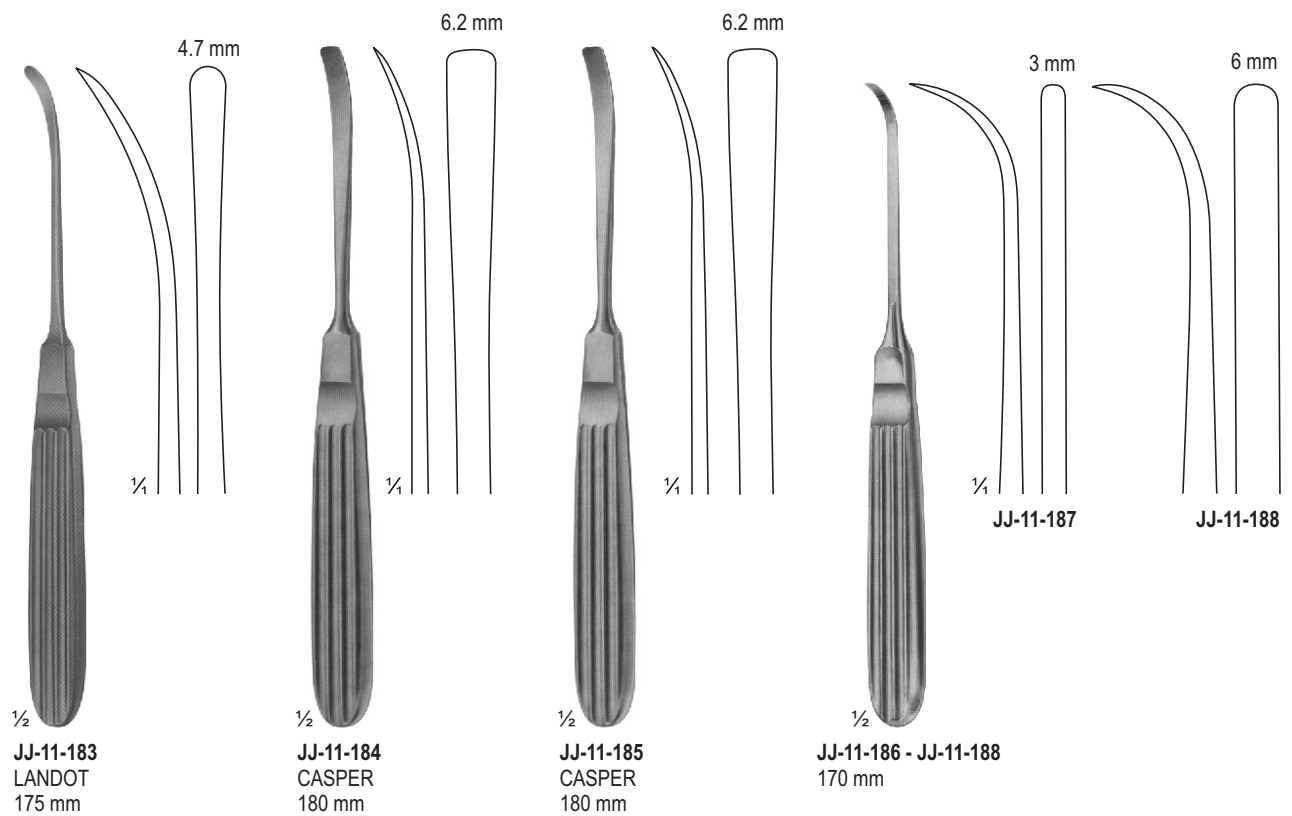
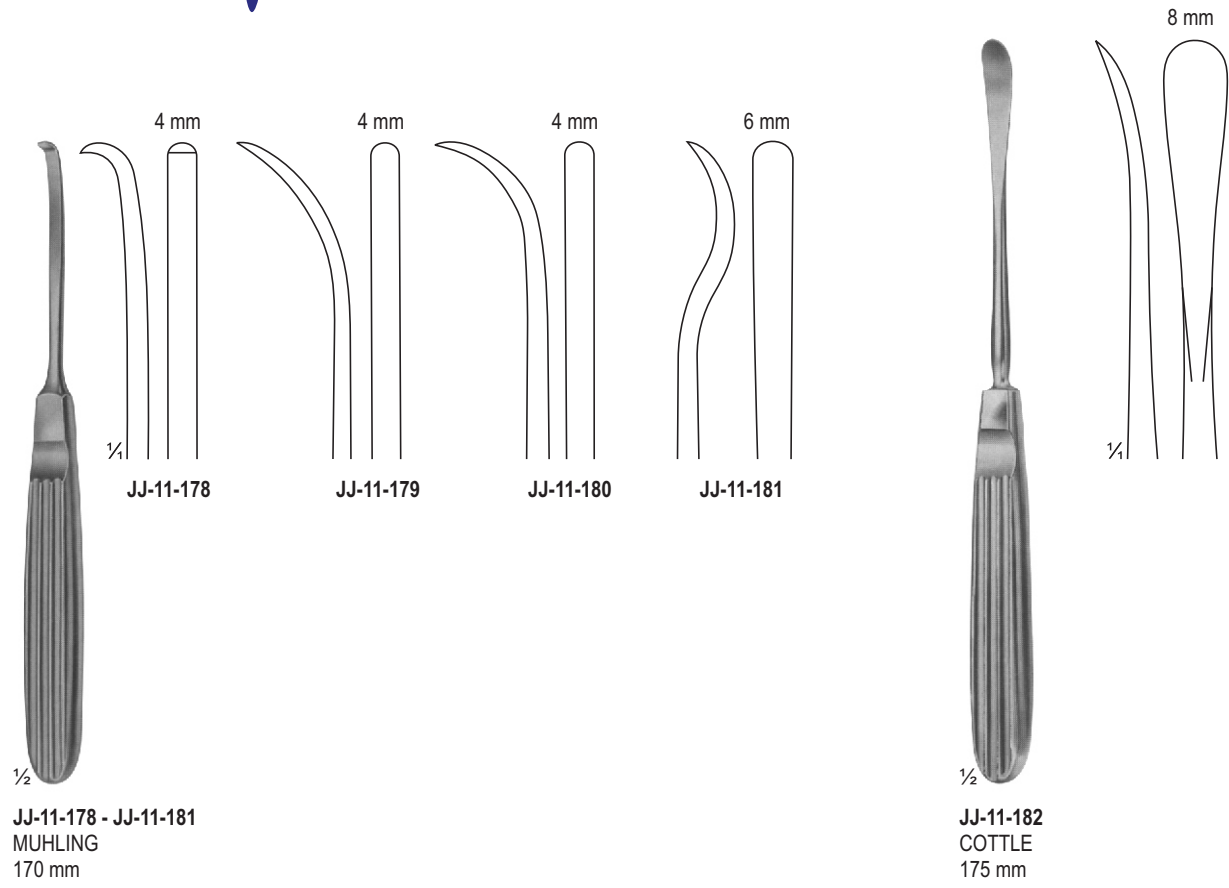

RASPATORIES

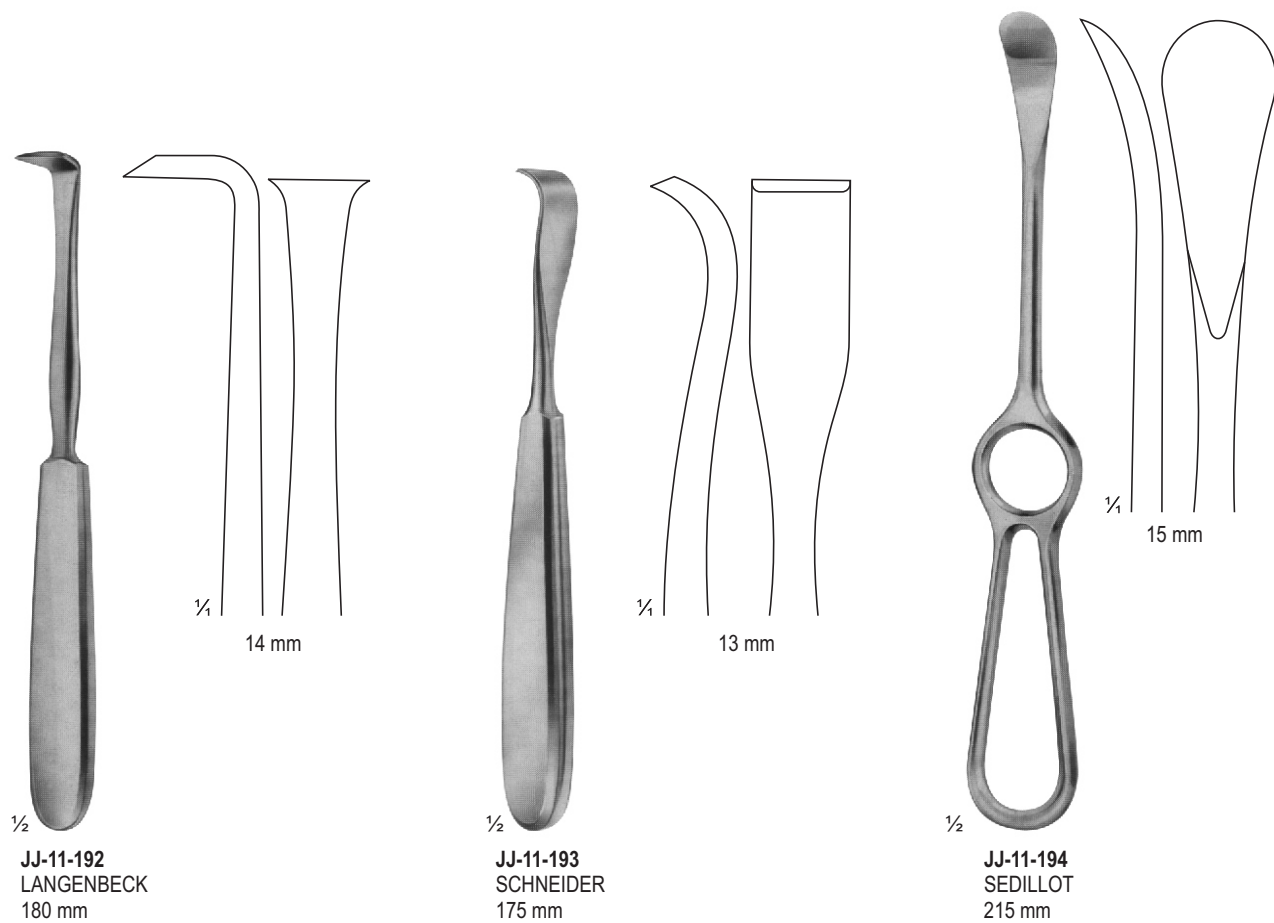
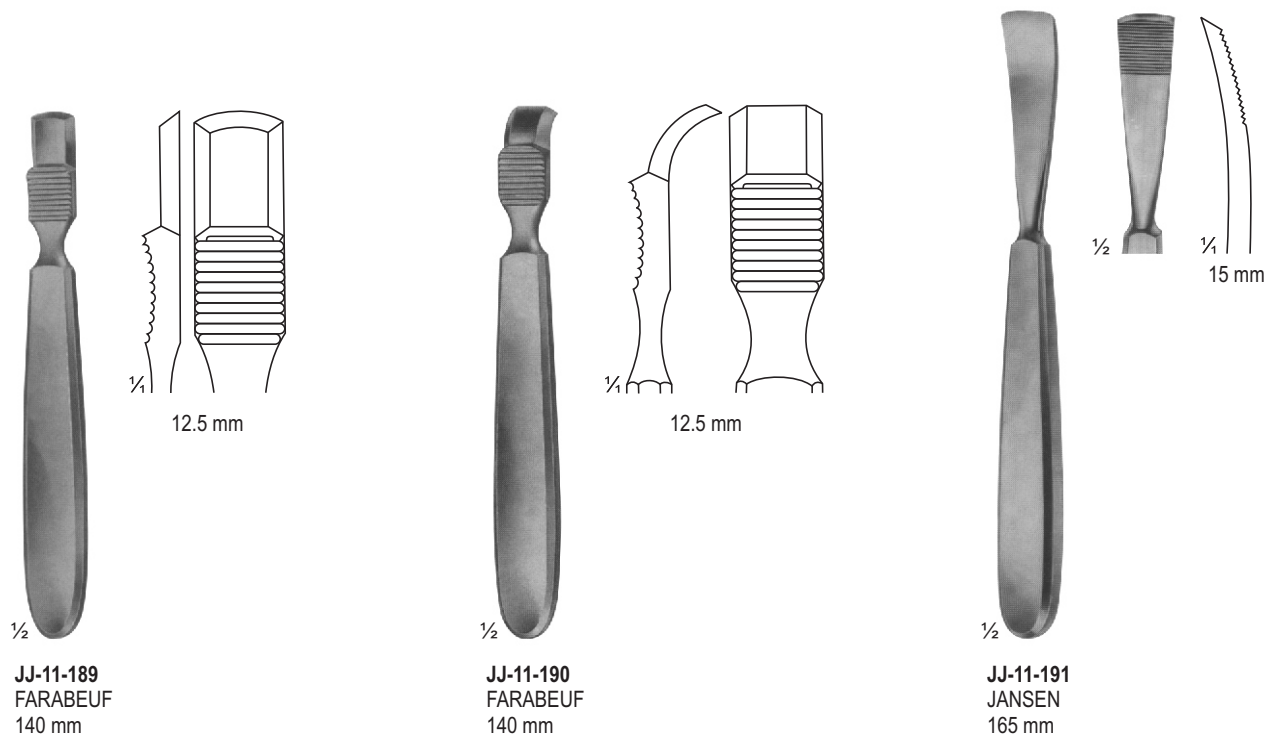

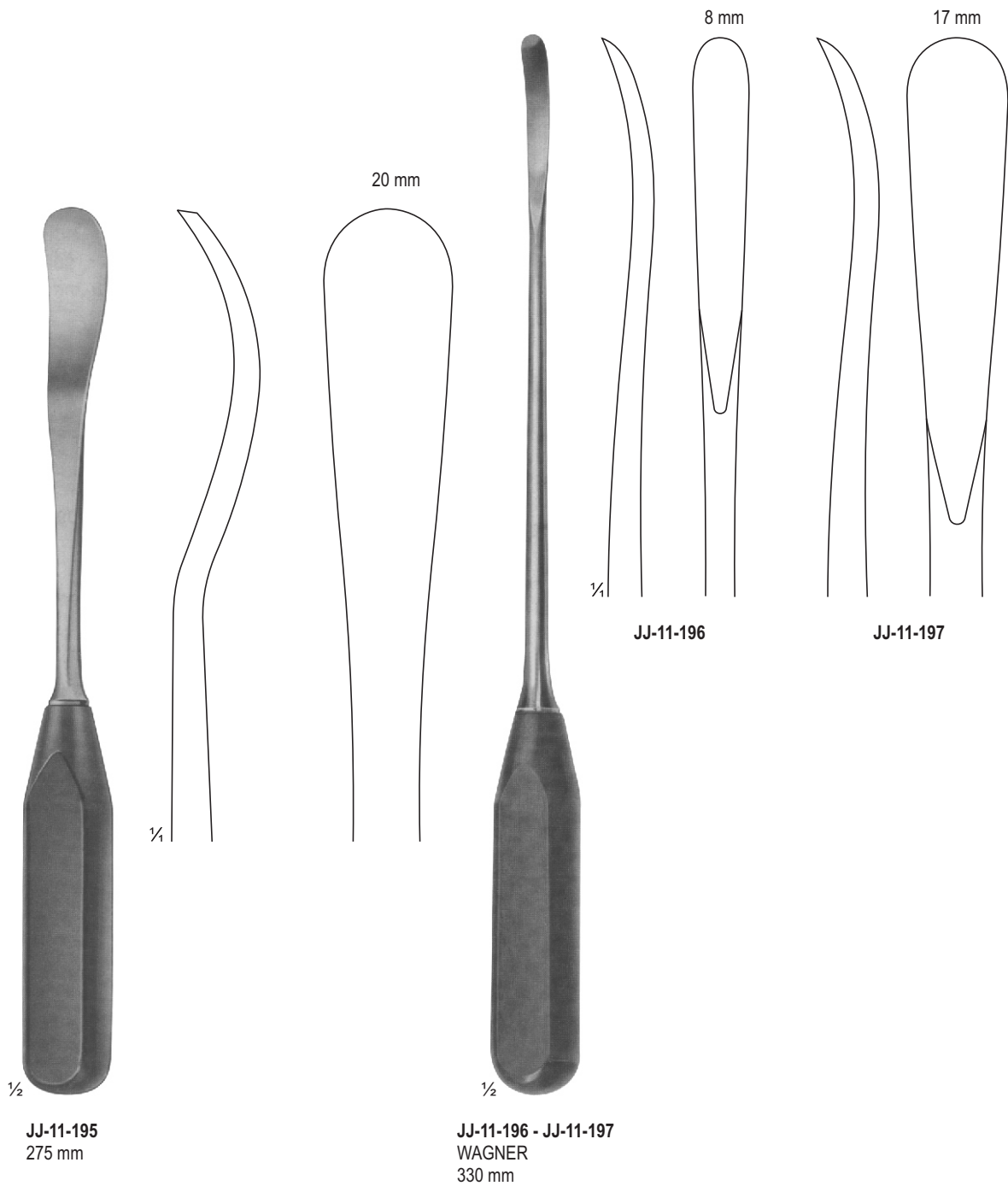

BONE CURETTES

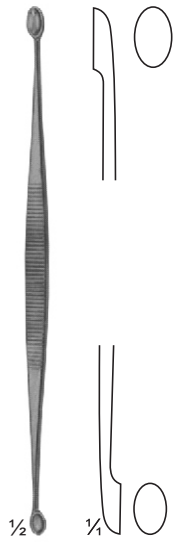

JJ-11-198
JACOBSON
140 mm

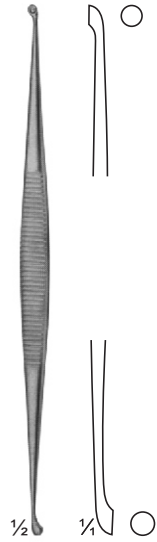

JJ-11-199
MARTINI
140 mm

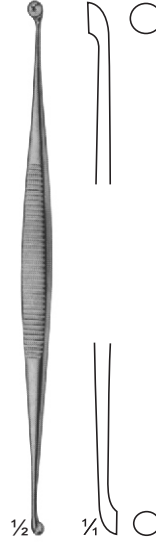

JJ-11-200
MARTINI
140 mm



JJ-11-201
WILLIGER
145 mm



JJ-11-202
JANSEN
160 mm



JJ-11-203
BARTH
180 mm

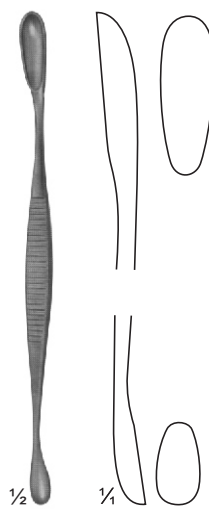

JJ-11-204
VOLKMANN
130 mm

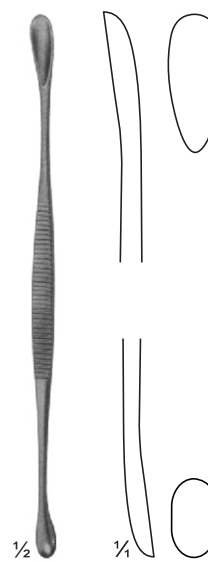

JJ-11-205
VOLKMANN
145 mm

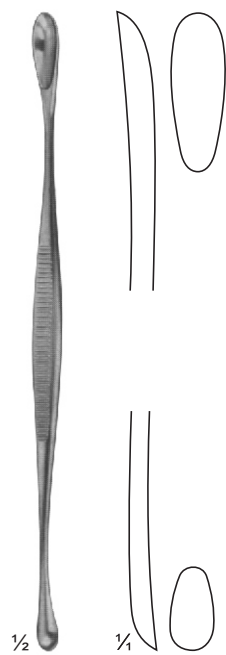

JJ-11-206
VOLKMANN
170 mm



JJ-11-207
JANSEN
160 mm

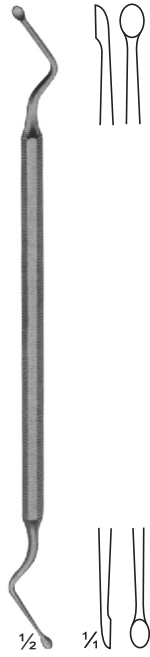

JJ-11-208
HEMINGWAY
170 mm

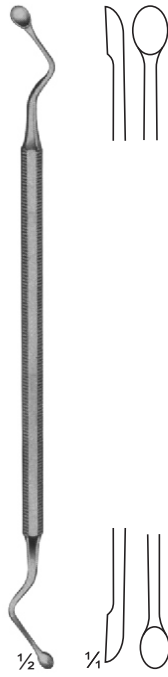

JJ-11-209
HEMINGWAY
175 mm

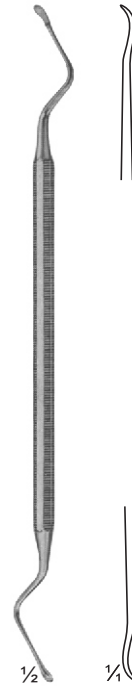

JJ-11-210
LUCAS
180 mm

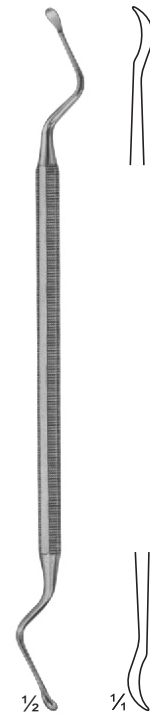

JJ-11-211
LUCAS
185 mm

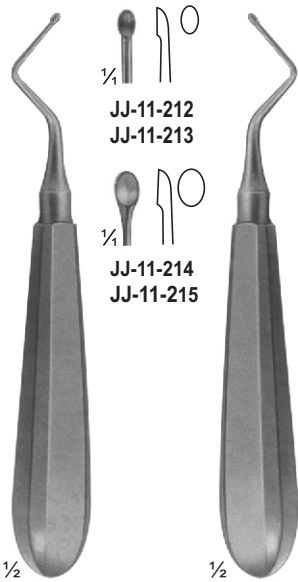

JJ-11-212 - JJ-11-213
KERPEL
145 mm

JJ-11-212
JJ-11-213

JJ-11-214
JJ-11-215

JJ-11-214 - JJ-11-215
KERPEL
145 mm

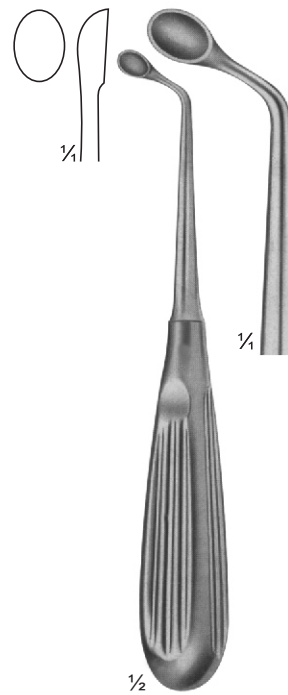

JJ-11-216
UFFENDORDE
170 mm

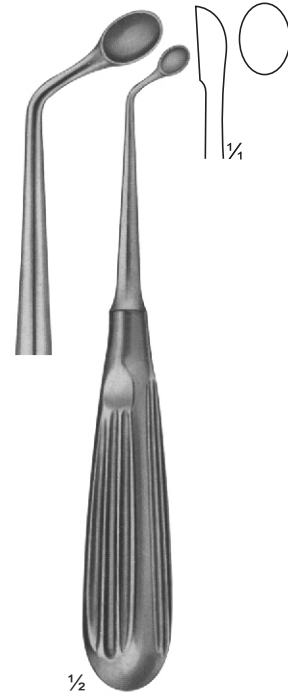

JJ-11-217
UFFENDORDE
170 mm

BONE CURETTES



JJ-11-218 - JJ-11-224
BRUNS
165 mm



JJ-11-218
3 mm
Fig: 000



JJ-11-219
4 mm
00



JJ-11-220
5 mm
0



JJ-11-221
6 mm
Fig: 1



JJ-11-222
8 mm
2



JJ-11-223
10 mm
3



JJ-11-224
12 mm
4



JJ-11-225 - JJ-11-231
SCHEDE
170 mm



JJ-11-225
2.5 mm
Fig: 000



JJ-11-226
3.4 mm
00



JJ-11-227
4.2 mm
0



RS-128
5.2 mm
Fig: 1



RS-129
6.3 mm
2



RS-130
7.4 mm
3



RS-131
8 mm
4



JJ-11-232 - JJ-11-241
VOLKMANN
170 mm



JJ-11-232
2,8 mm
Fig: 0000



JJ-11-233
3,6 mm
000



JJ-11-234
4,4 mm
00



JJ-11-235
5,2 mm
0



JJ-11-236
6,8 mm
1



JJ-11-237
8,5 mm
Fig: 2



JJ-11-238
10 mm
3



JJ-11-239
11,5 mm
4

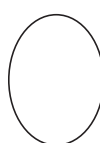

JJ-11-240
13 mm
5



JJ-11-241
14,5 mm
6



JJ-11-242 - JJ-11-243
WILLIGER
170 mm



JJ-11-242
3,4 mm
Fig: 00





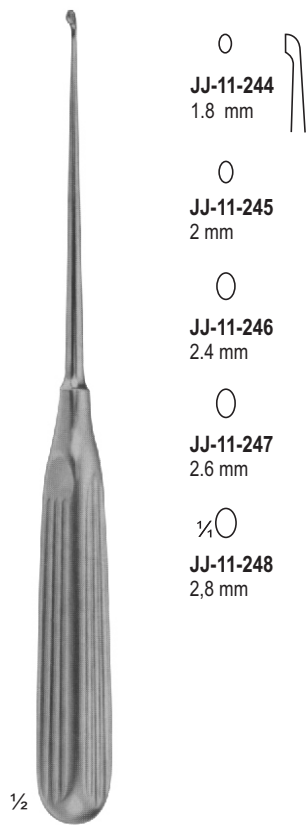

JJ-11-243
5,2 mm
1

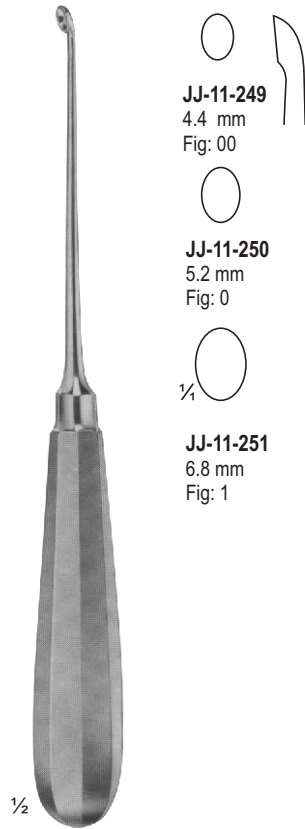

-  **JJ-11-244**
1.8 mm
-  **JJ-11-245**
2 mm
-  **JJ-11-246**
2.4 mm
-  **JJ-11-247**
2.6 mm
-  **JJ-11-248**
2,8 mm





JJ-11-244 - JJ-11-248
LEMPERT
215 mm

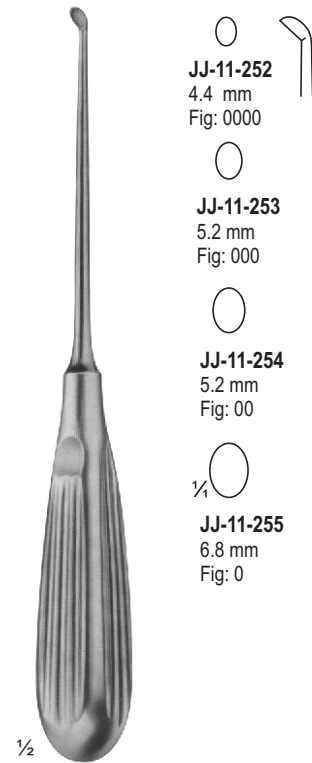

-  **JJ-11-249**
4.4 mm
Fig: 00
-  **JJ-11-250**
5.2 mm
Fig: 0
-  **JJ-11-251**
6.8 mm
Fig: 1

JJ-11-249 - JJ-11-251
HALLE
215 mm



-  **JJ-11-252**
4.4 mm
Fig: 0000
-  **JJ-11-253**
5.2 mm
Fig: 000
-  **JJ-11-254**
5.2 mm
Fig: 00
-  **JJ-11-255**
6.8 mm
Fig: 0

JJ-11-252 - JJ-11-255
DAUBENSPECK
200 mm

BONE CURETTES



JJ-11-256
 3.6 mm
 Fig: 000

JJ-11-257
 4.4 mm
 Fig: 00

JJ-11-258
 5.2 mm
 Fig: 0

JJ-11-259
 6.8 mm
 Fig: 1

1/2

JJ-11-256 - JJ-11-259
250 mm



JJ-11-260
 3.6 mm
 Fig: 000

JJ-11-261
 4.4 mm
 Fig: 00

JJ-11-262
 5.2 mm
 Fig: 0



JJ-11-263
 6.8 mm
 Fig: 1

1/2

JJ-11-260 - JJ-11-263
250 mm



JJ-11-264
 3 mm

JJ-11-265
 4 mm

JJ-11-266
 5 mm

1/2

JJ-11-264 - JJ-11-266
BUSHE
250 mm

¼ 0

Fig. 1
JJ-11-267

¼ 0

Fig. 1
JJ-11-273

¼ 0

Fig. 1
JJ-11-2179

0

Fig. 2
JJ-11-268

0

Fig. 2
JJ-11-274

0

Fig. 2
RS-1SF-11-2

0

Fig. 3
JJ-11-269

0

Fig. 3
JJ-11-275

0

Fig. 3
RS-1SF-11-2

0

Fig. 4
JJ-11-270

0

Fig. 4
RS-1SF-11-2

0

Fig. 4
JJ-11-282



0

Fig. 5
JJ-11-271

0

Fig. 5
JJ-11-277

0

Fig. 5
JJ-11-283

0

Fig. 6
JJ-11-272

0

Fig. 6
JJ-11-278

0

Fig. 6
JJ-11-284



MODELL USA
Oval, With Hollow Handle
JJ-11-267 - JJ-11-272
165 mm

MODELL USA
Oval, With Hollow Handle
JJ-11-273 - JJ-11-278
165 mm

MODELL USA
Oval, With Hollow Handle
JJ-11-279 - JJ-11-284
16 mm

Page
242

▪ Trocars

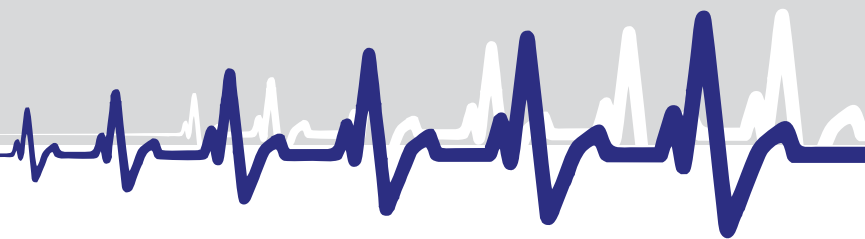

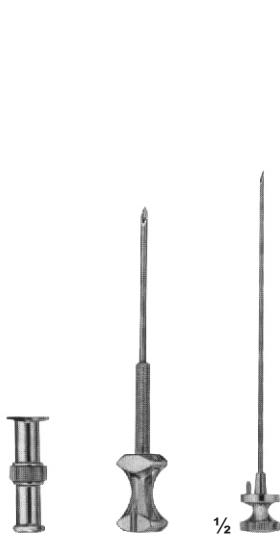

JJ-12-101
KLIMA ROSEGGER
35 X 1,8 mm
Sternal puncture needle

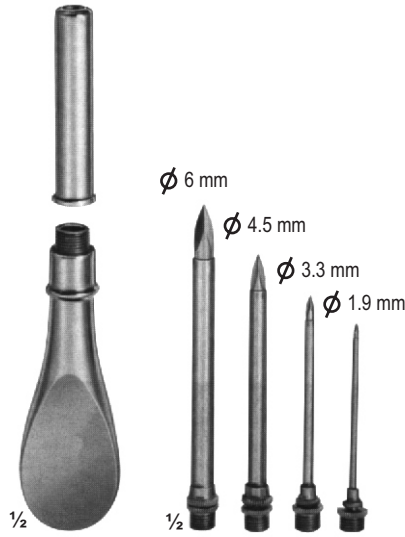

JJ-12-102
Universal trocar
with 4 tips



JJ-12-103 - JJ-12-107
Inside dime. Outside dime
JJ-12-103 2,2 mm 3,0 mm
JJ-12-104 3,0 mm 4,0 mm
JJ-12-105 4,0 mm 5,0 mm
JJ-12-106 5,0 mm 6,0 mm
JJ-12-107 5,5 mm 6,5 mm
 for hydrocele and abdominal puncture



JJ-12-108 - JJ-12-111
Inside dime. Outside dime
JJ-12-108 2,2 mm 3,0 mm
JJ-12-109 3,0 mm 4,0 mm
JJ-12-110 4,0 mm 5,0 mm
JJ-12-111 5,0 mm 6,0 mm
 for abdominal puncture,
 with stop-cock and lateral drain

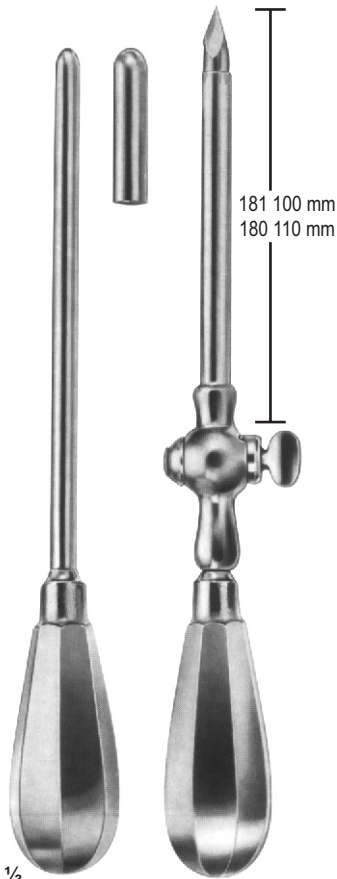

JJ-12-112 - JJ-12-113
Inside dime. Outside dime
JJ-12-112 6,5 mm 8 mm
JJ-12-113 9 mm 10 mm
 Emphyema trocar

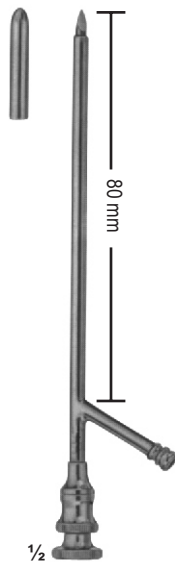

JJ-12-114 - JJ-12-117
Inside dime. Outside dime
JJ-12-114 3 mm 4 mm
JJ-12-115 3,6 mm 4,6 mm
JJ-12-116 4,3 mm 5,3 mm
JJ-12-117 5 mm 6 mm
 Gall bladder trocars



JJ-12-118
PIERCE
Antrum trocar
4 mm



JJ-12-119
COAKLEY
Antrum trocar
3 mm

Page
243–253

▪ Vaginal Specula

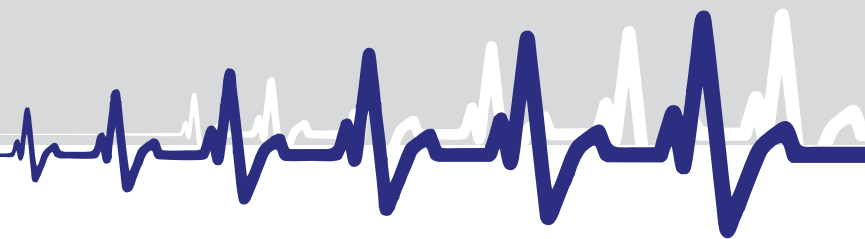

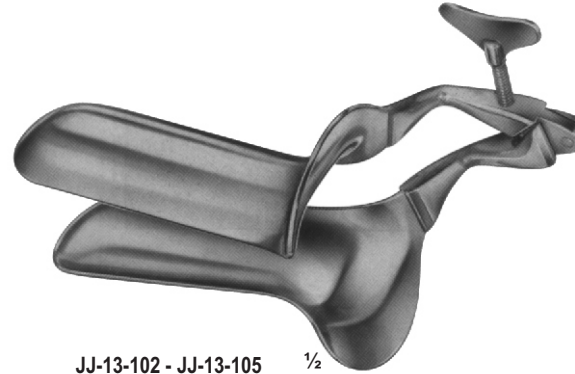

JJ-13-102 - JJ-13-105 ½
COLLIN
JJ-13-102 100/90mm 28 mm
JJ-13-103 100/90mm 32 mm
JJ-13-104 105/95mm 35 mm
JJ-13-105 115/105mm 40 mm
 Total length/working width
 length

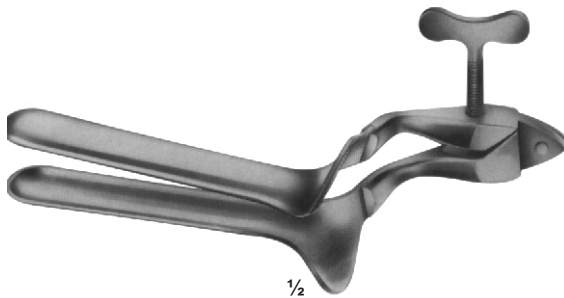

½
JJ-13-106
 COLLIN
 for virgins
 95/85 x 18 mm



½
JJ-13-107
 CUSCO
 for virgins
 75 x17 mm

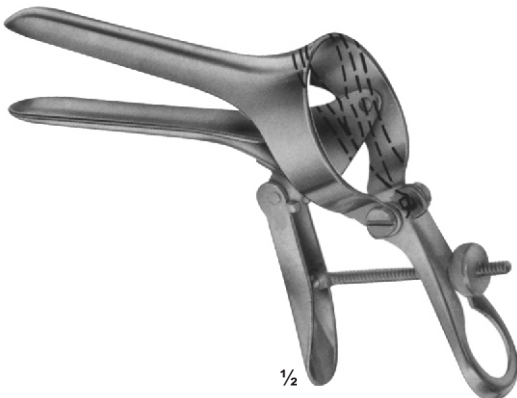

½
JJ-13-108
 CUSCO
 for virgins
 75 x17 mm

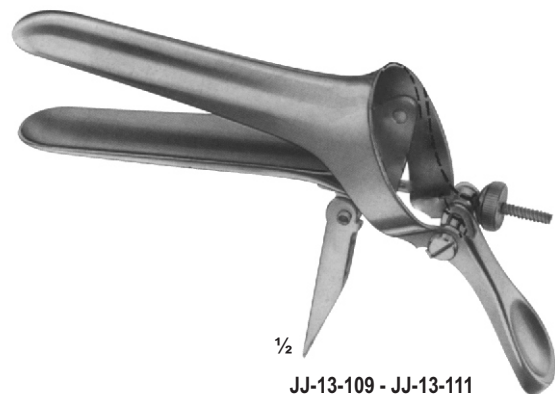

½
JJ-13-109 - JJ-13-111
 CUSCO
MN-009 92X23-25 mm
MN-010 100x25-27 mm
MN-011 110x27-30 mm

VAGINAL SPECULA

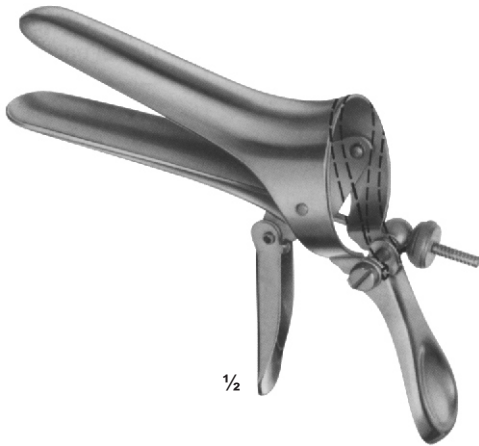

JJ-13-112 - JJ-13-115
 CUSCO
 STANDARD
 JJ-13-112 80X24 mm
 JJ-13-113 80X32 mm
 JJ-13-114 90X36 mm
 JJ-13-115 110X37 mm

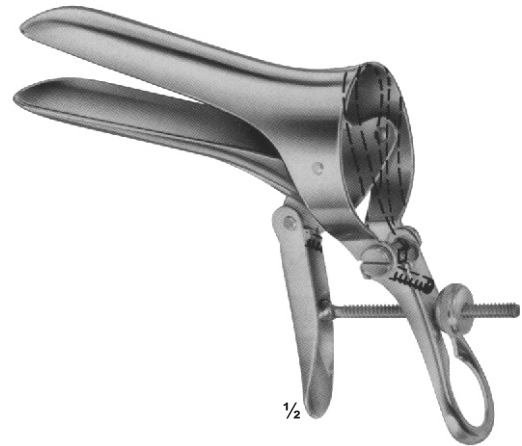

JJ-13-116 - JJ-13-119
 CUSCO
 JJ-13-116 80X24 mm
 JJ-13-117 80X32 mm
 JJ-13-118 90X36 mm
 JJ-13-119 110X37 mm



JJ-13-120 - JJ-13-122
 CUSCO
 JJ-13-120 80X24 mm
 JJ-13-121 80X32 mm
 JJ-13-122 115X36 mm

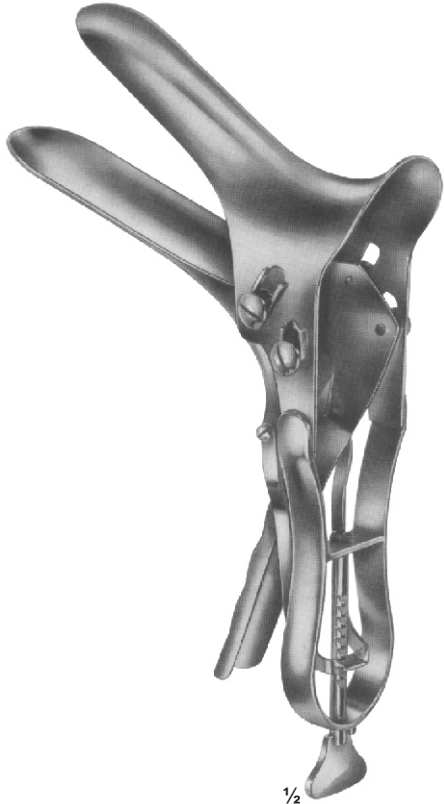

JJ-13-123 - JJ-13-124
 SEYFFERT
 JJ-13-123 100X24 mm
 JJ-13-124 110X32 mm
 230 mm



JJ-13-125
 SEMM
 for children
 and virgins
 180 mm

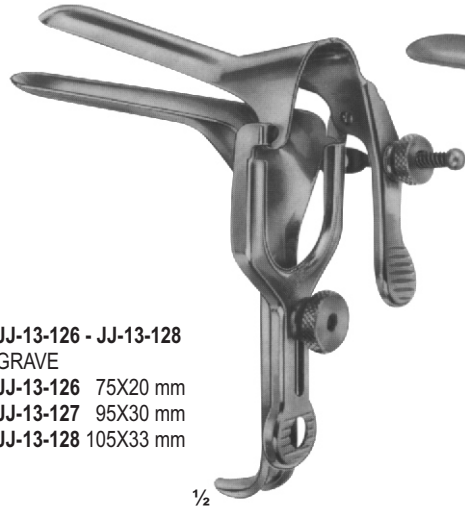

JJ-13-126 - JJ-13-128
GRAVE
JJ-13-126 75X20 mm
JJ-13-127 95X30 mm
JJ-13-128 105X33 mm

1/2

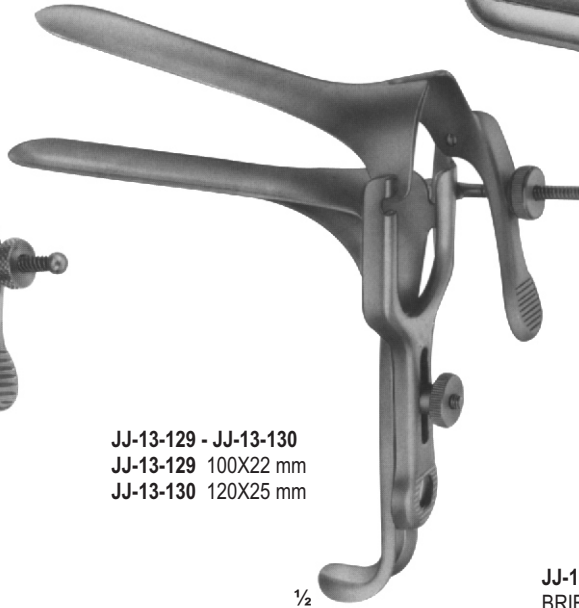

JJ-13-129 - JJ-13-130
JJ-13-129 100X22 mm
JJ-13-130 120X25 mm

1/2

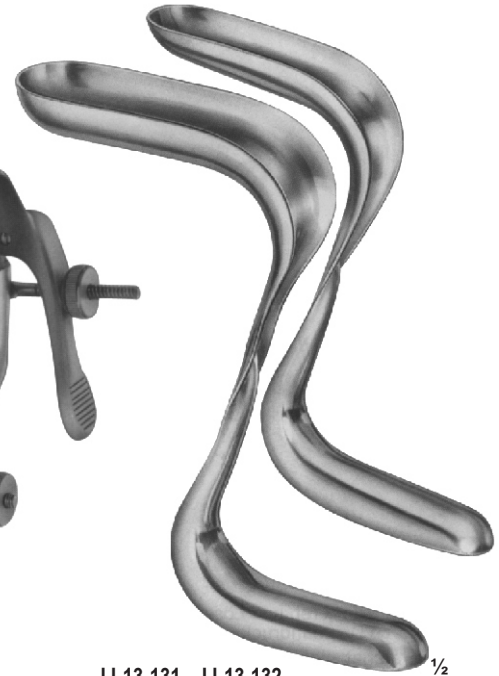

JJ-13-131 - JJ-13-132
BRIESKY
JJ-13-131 72X25 mm / 77X30 mm
JJ-13-132 75X30 mm / 92X38 mm
170 mm

1/2



1/2

JJ-13-133 - JJ-13-134
BREISKY
JJ-13-133 100X22 mm
77 X30 mm
140 mm
JJ-13-134 120X25 mm
92 X38 mm
170 mm

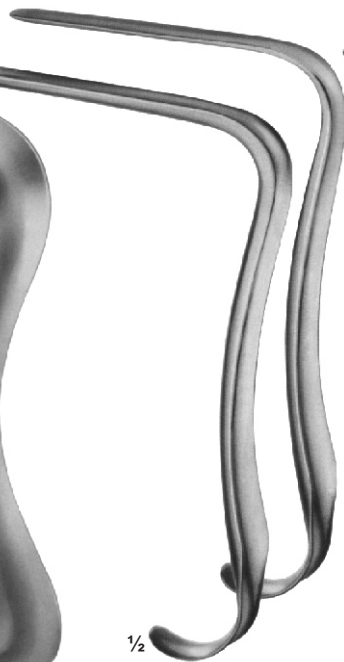

1/2

JJ-13-135 - JJ-13-137
SEIDL
JJ-13-135 80X8 mm
JJ-13-136 80X10 mm
JJ-13-137 90X14 mm
For children and infants
170 mm



1/2

JJ-13-138
KRISTELLER
70X15 mm, (170 mm)
For children



1/2

JJ-13-139 - JJ-13-141
SIMS
JJ-13-139 70X26 mm
75 X30 mm 125 mm
JJ-13-140 75X30 mm
80 X85 mm 150 mm
JJ-13-141 80X36 mm
90 X40 mm 175 mm

VAGINAL SPECULA, UPPER & LOWER BLADES



JJ-13-142 - JJ-13-146
 KRISTELLER
 JJ-13-142 110X18 mm
 JJ-13-143 110X20 mm
 JJ-13-144 110X27 mm
 JJ-13-145 110X30 mm
 JJ-13-146 110X36 mm
 220 mm

JJ-13-147 - JJ-13-150
 KRISTELLER
 Upper blades

JJ-13-151 - JJ-13-154
 KRISTELLER
 Lower blades

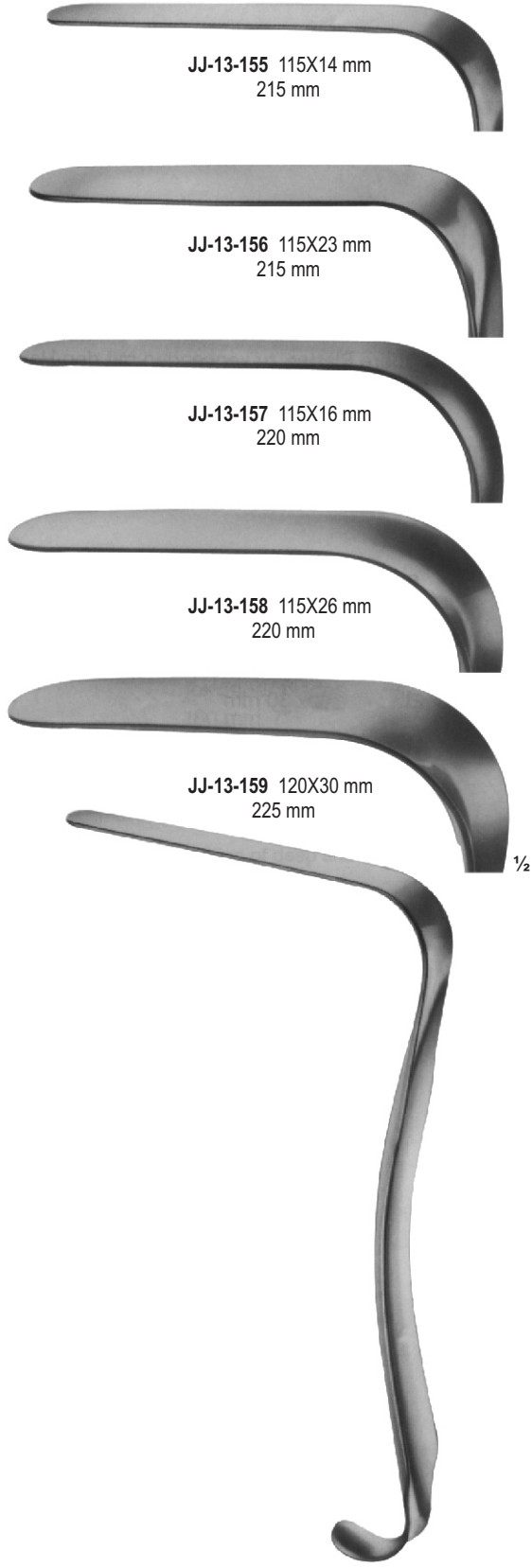

JJ-13-155 115X14 mm
215 mm

JJ-13-156 115X23 mm
215 mm

JJ-13-157 115X16 mm
220 mm

JJ-13-158 115X26 mm
220 mm

JJ-13-159 120X30 mm
225 mm

1/2



JJ-13-160 110X18 mm
215 mm

JJ-13-161 110X27 mm
215 mm

JJ-13-162 110X20 mm
220 mm

JJ-13-163 110X30 mm
220 mm

JJ-13-164 110X36 mm
225 mm

JJ-13-155 - JJ-13-159
KRISTELLER
Upper blades

VAGINAL SPECULA, UPPER LOWER BLADES

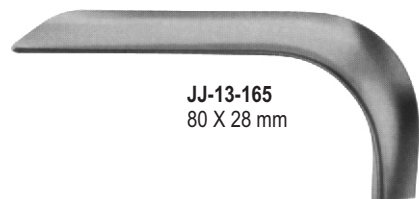

JJ-13-165
80 X 28 mm



JJ-13-166
85 X 35 mm

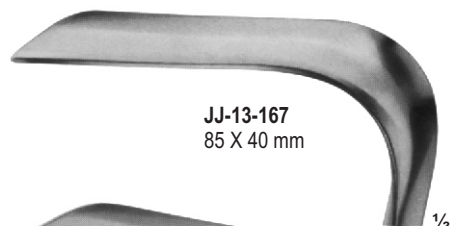

JJ-13-167
85 X 40 mm



Slightly Concave

JJ-13-165 - JJ-13-167
KRISTELLER
205 mm

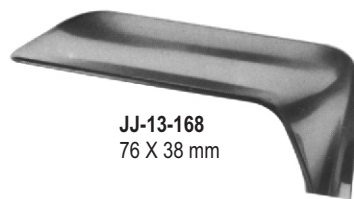

JJ-13-168
76 X 38 mm

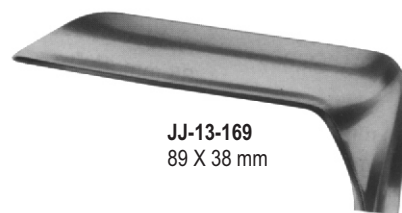

JJ-13-169
89 X 38 mm

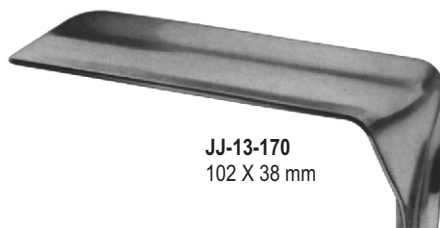

JJ-13-170
102 X 38 mm



Slightly Concave

JJ-13-168 - JJ-13-170
JACKSON
175 mm



1/2
JJ-13-171
BRAUN
180 mm

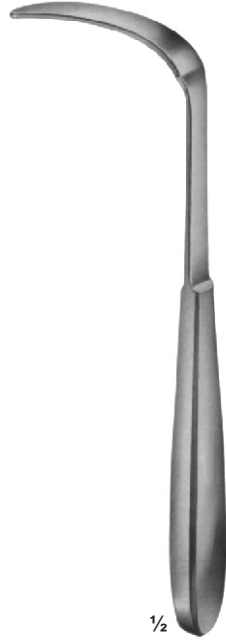

1/2
JJ-13-172
BRAUN
180 mm

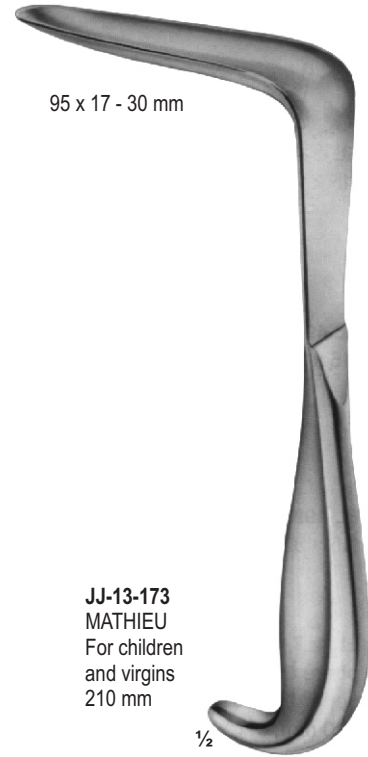

95 x 17 - 30 mm

JJ-13-173
MATHIEU
For children
and virgins
210 mm

1/2



95 x 17-26 mm

JJ-13-174
MATHIEU
for children and
virgins fitting
210 mm

1/2



JJ-13-175
Handle with cold light
carrier for upper blades
280 mm

1/2

VAGINAL SPECULA





1/2

JJ-13-190 - JJ-13-194
BREISKY
WIENER MODELL/
VIENNA PATTERN
JJ-13-190 100 X 20 mm
JJ-13-191 100 X 25 mm
JJ-13-192 100 X 30 mm
JJ-13-193 100 X 35 mm
JJ-13-194 100 X 40 mm
300 mm



1/2

JJ-13-195 - JJ-13-199
BREISKY
WIENER MODELL/
VIENNA PATTERN
JJ-13-195 130 X 20 mm
JJ-13-196 130 X 25 mm
JJ-13-197 130 X 30 mm
JJ-13-198 130 X 35 mm
JJ-13-199 130 X 40 mm
320 mm

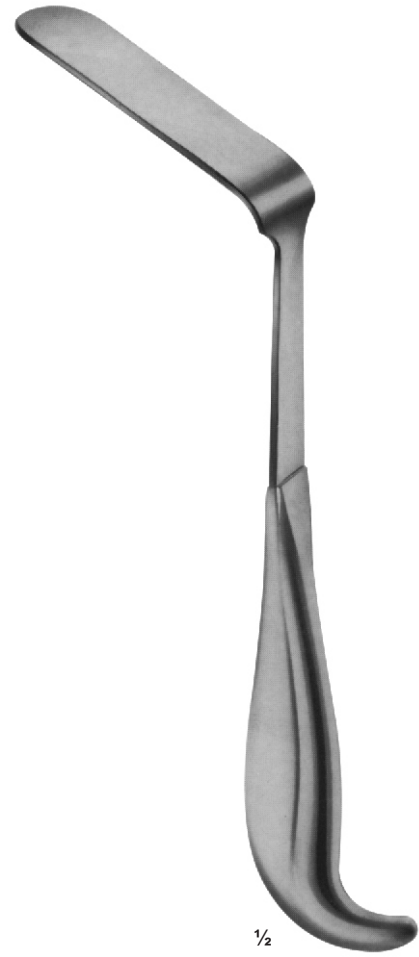

1/2

JJ-13-200
DOYEN
lateral speculum
80 x 30 mm
250 mm



1/2
JJ-13-201
 SIMON
 115 X 22 mm
 275 mm



JJ-13-202
 AUVARD
 65 X 38 mm - 28 mm
 1,530 kg
 with fixed weight
 230 mm



JJ-13-203 - JJ-13-204
 AUVARD
JJ-13-203 75 X 42 mm
 (40 mm)
JJ-13-204 105 X 43 mm
 (40 mm)
 with detachable wight
 230 mm

JJ-13-205
80 X 30

JJ-13-208
55 X 40 - 60 mm

JJ-13-206
85 X 35

JJ-13-209
70 X 45 - 70 mm

JJ-13-207
85 X 40

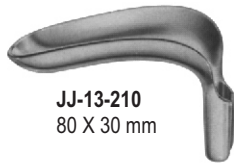

JJ-13-210
80 X 30 mm



JJ-13-214
65 X 30 mm

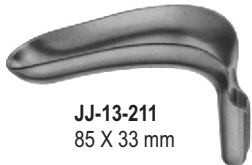

JJ-13-211
85 X 33 mm



JJ-13-215
75 X 35 mm

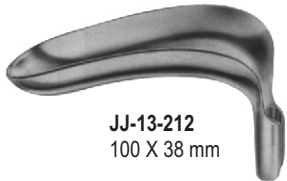

JJ-13-212
100 X 38 mm



JJ-13-216
85 X 35 mm

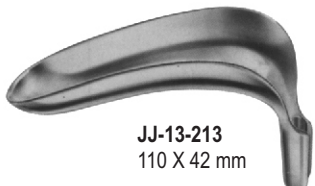

JJ-13-213
110 X 42 mm



JJ-13-217
95 X 35 mm

SCHERBACK
JJ-13-210 - JJ-13-217
Set consisting of:
2 handle
8 blades



1/3

Page
254–288

- Wound Retractors

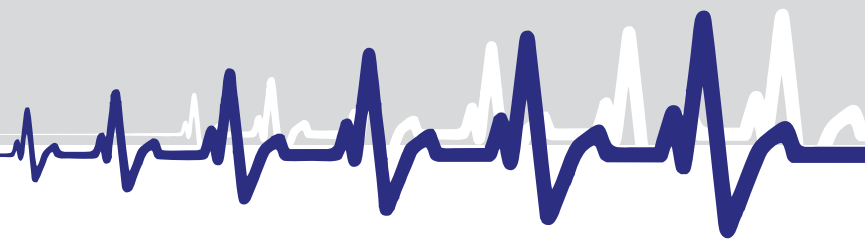

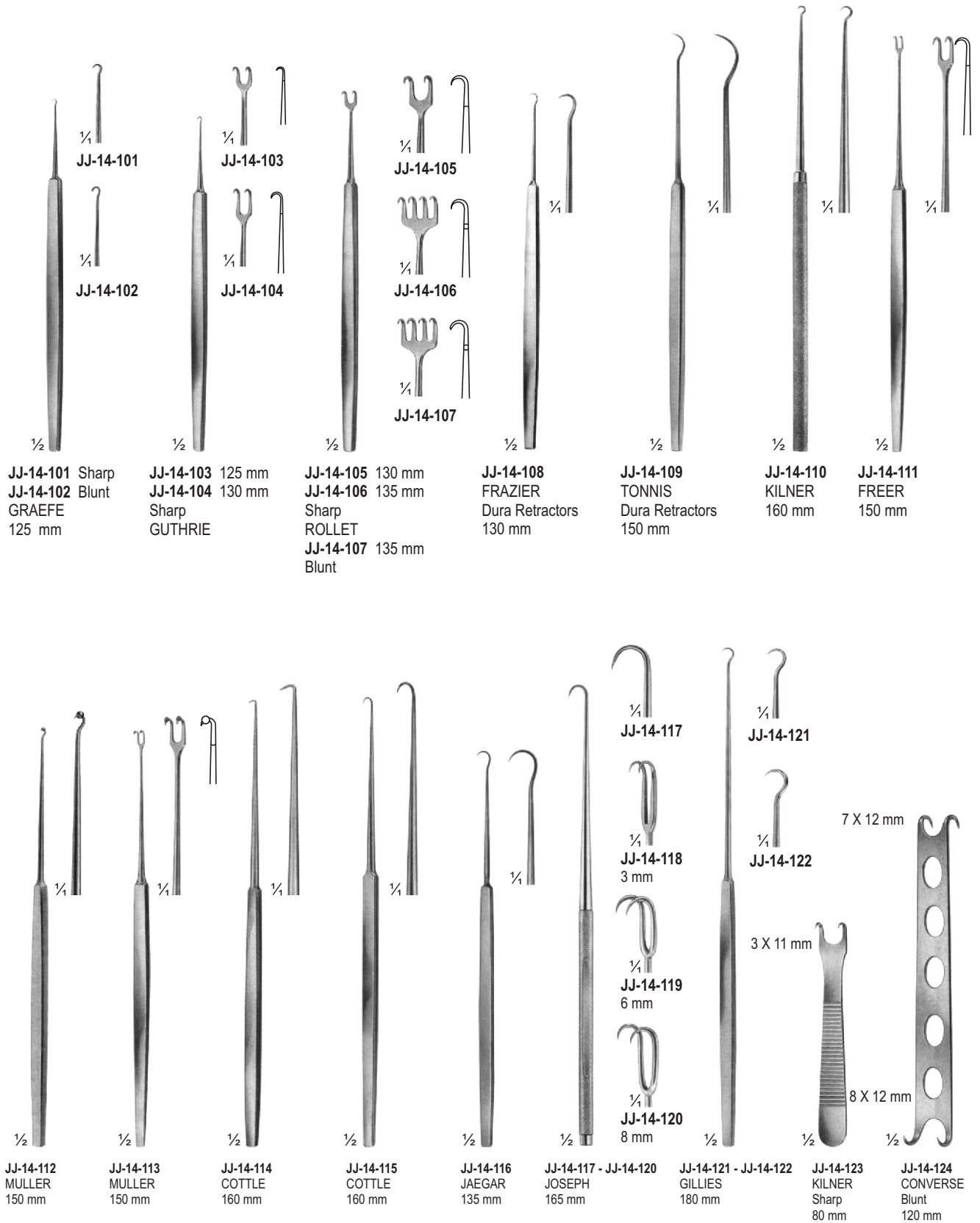

WOUND - TRACHEA RETRACTORS

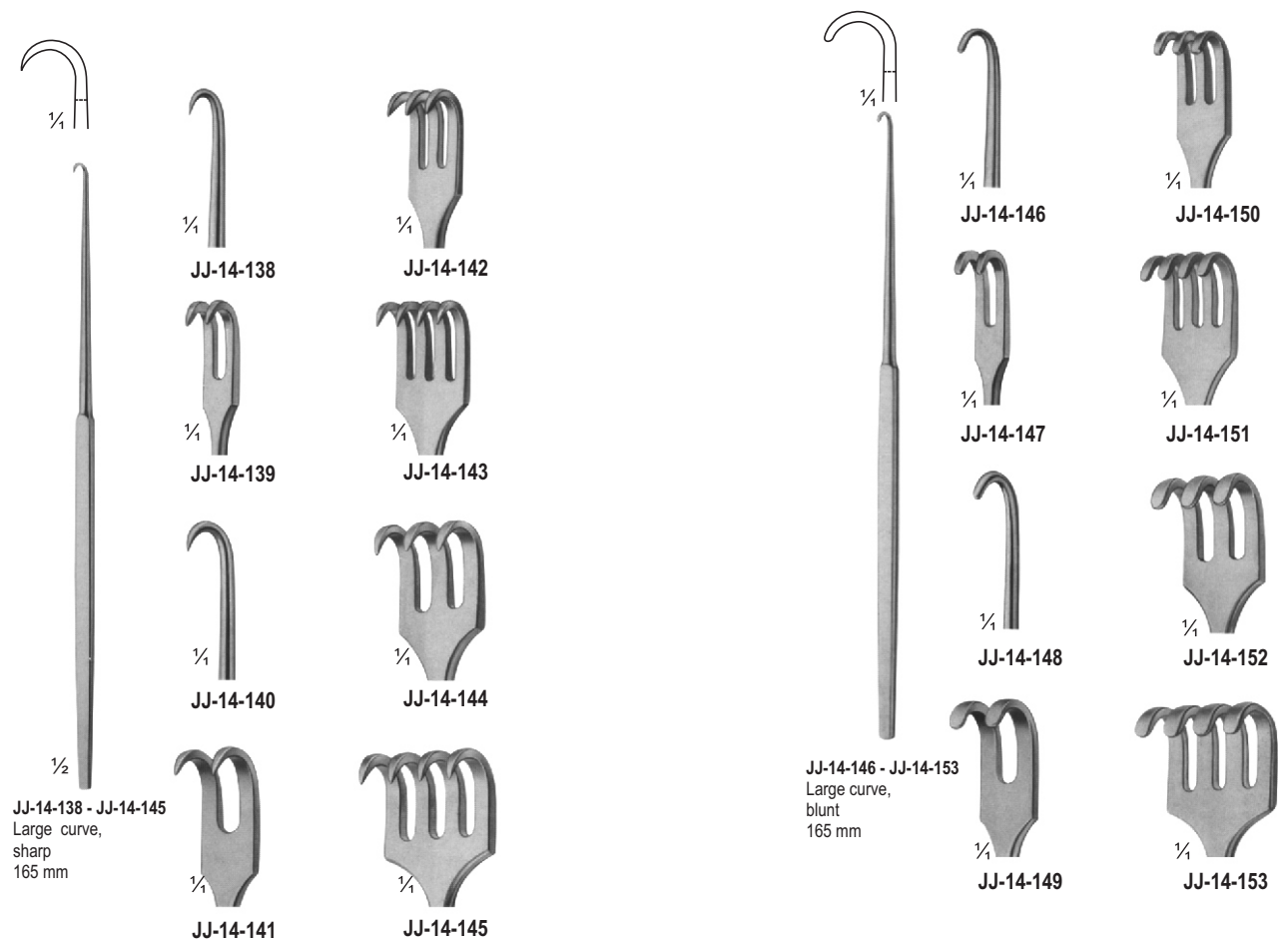
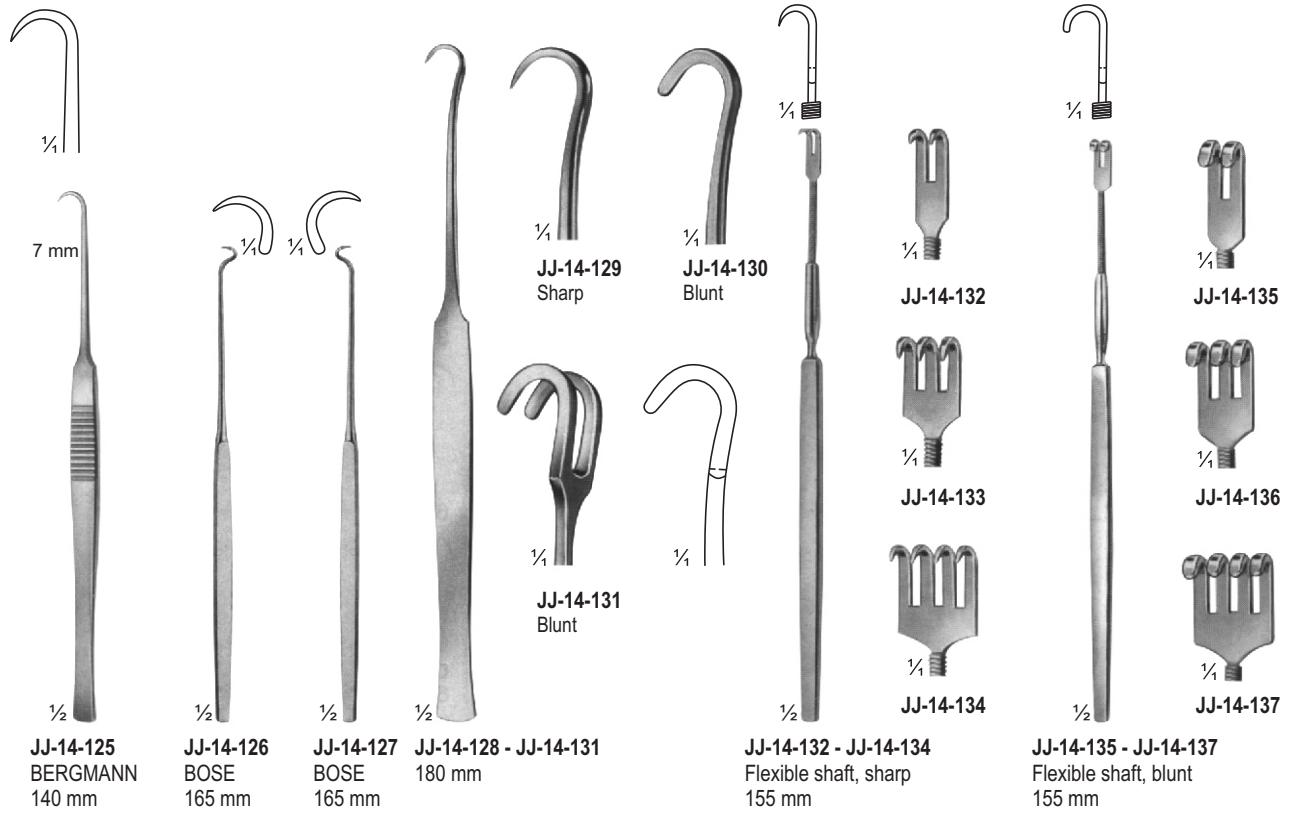

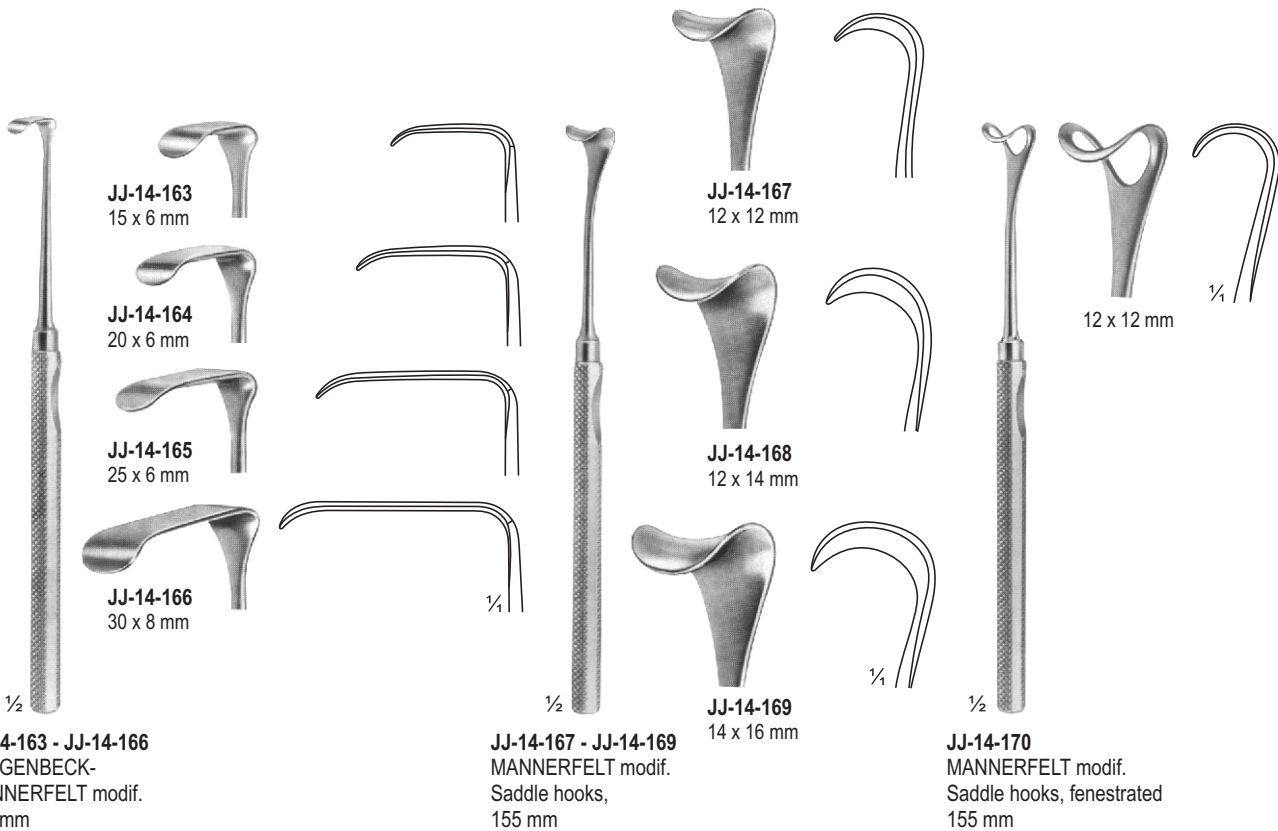
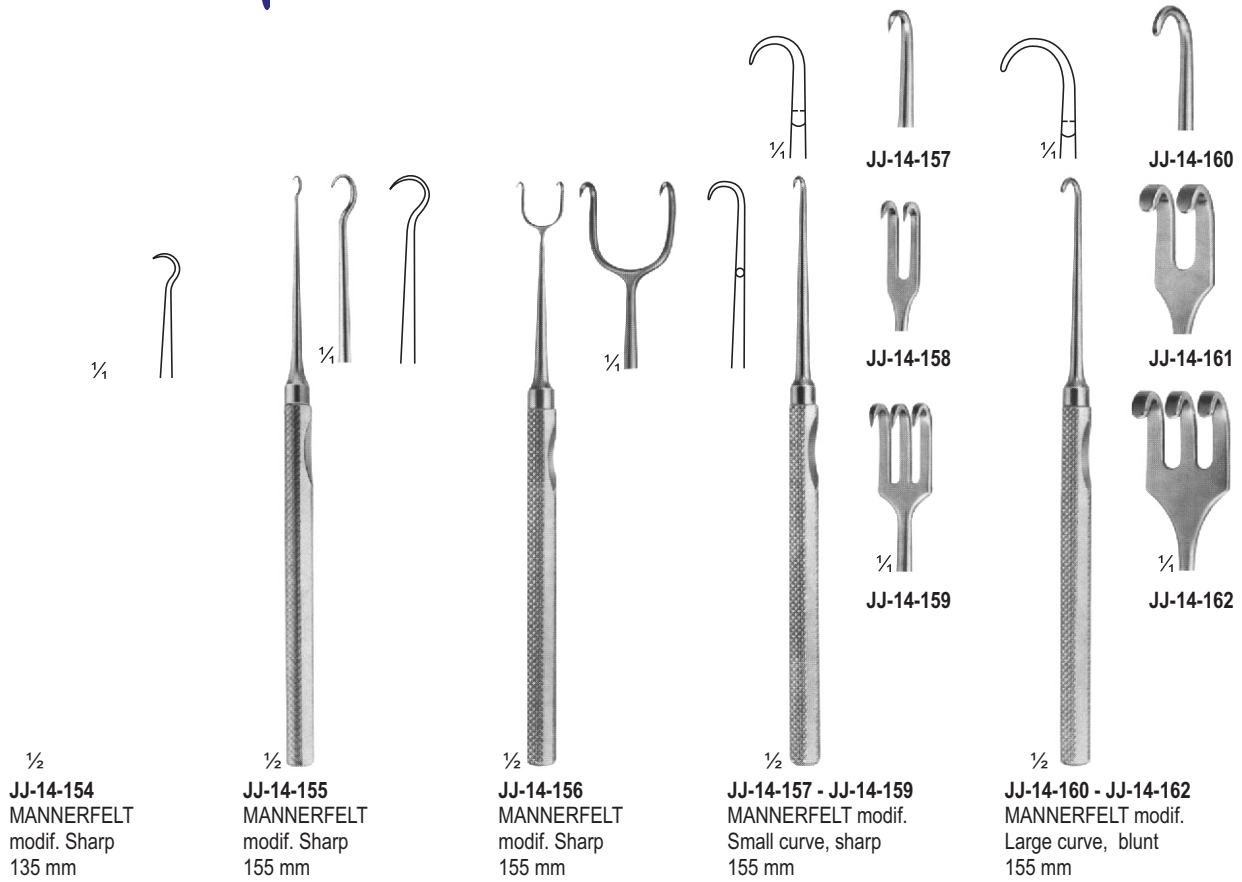

RETRACTORS

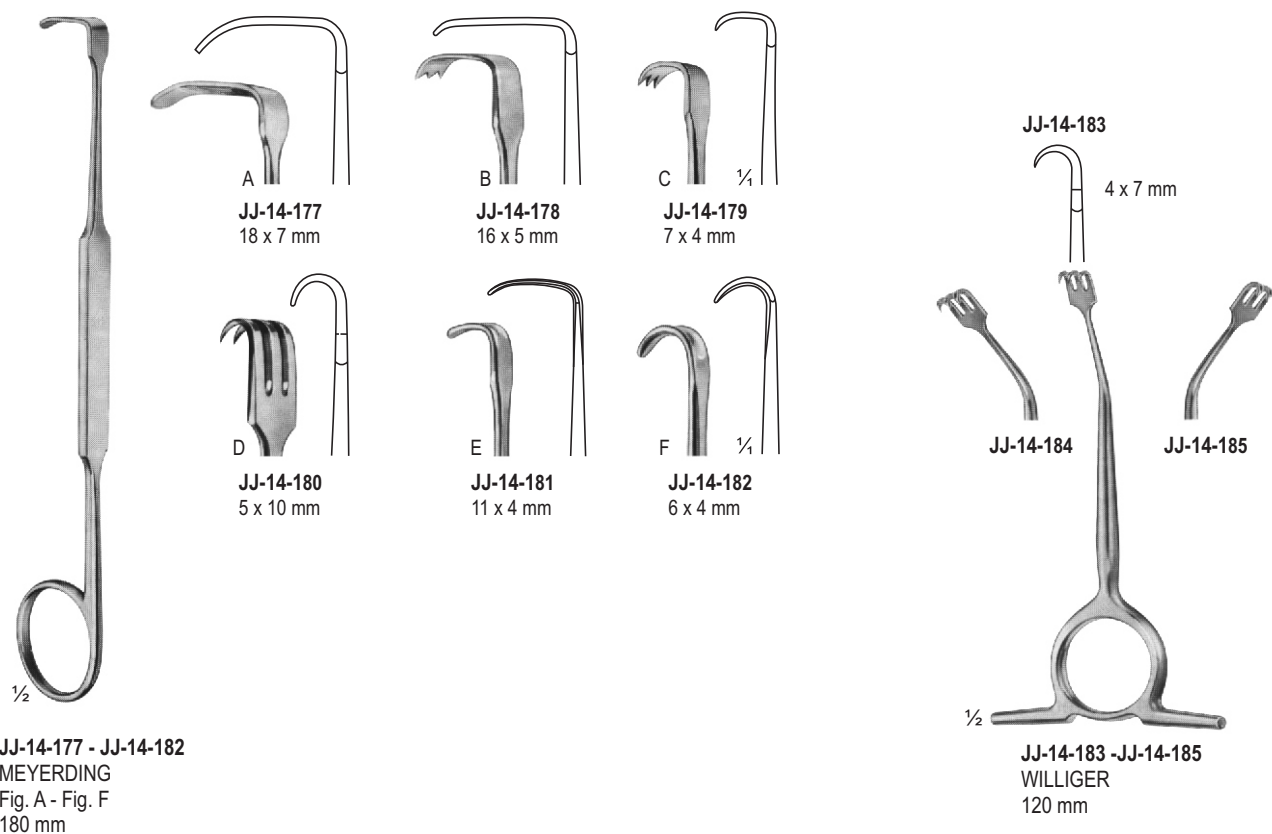
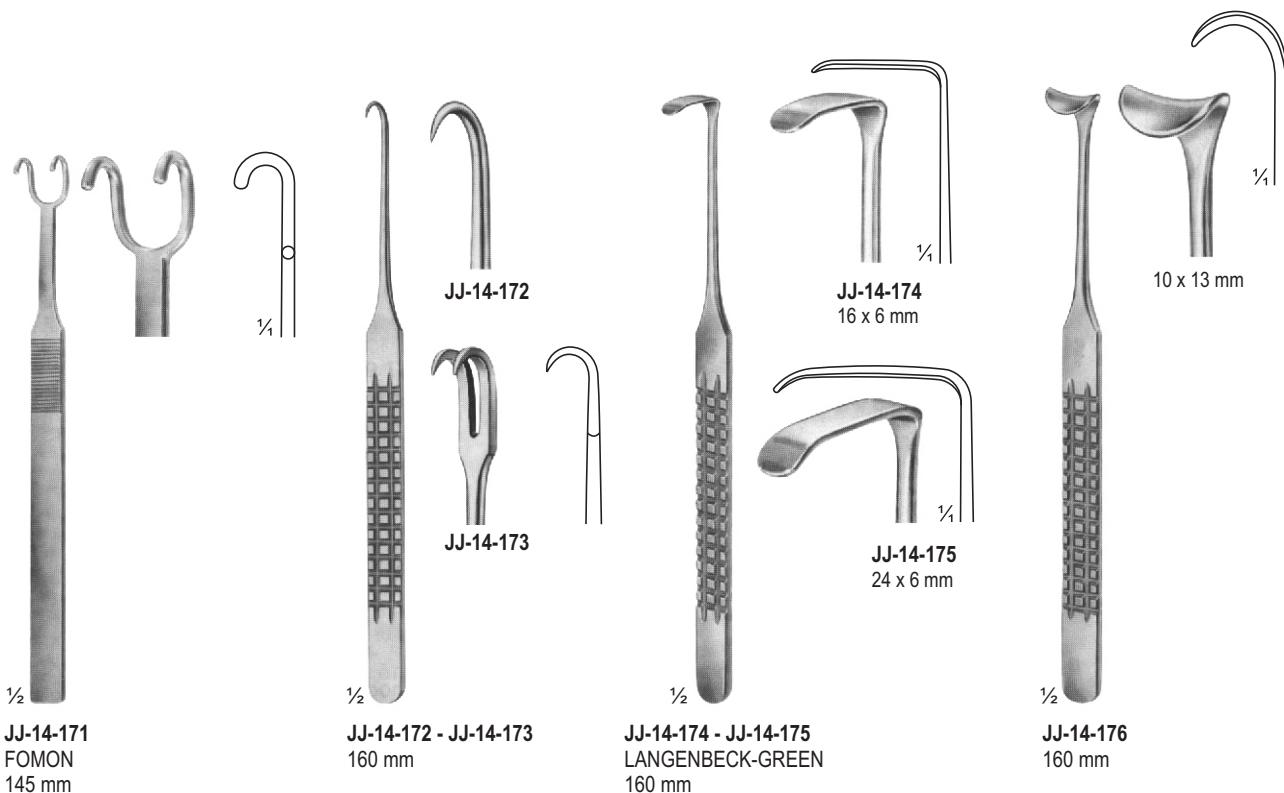



JJ-14-186
EMMET
Fistula hook
220 mm

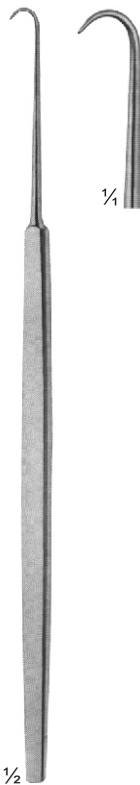

JJ-14-187
SIMON
Fistula hook
220 mm

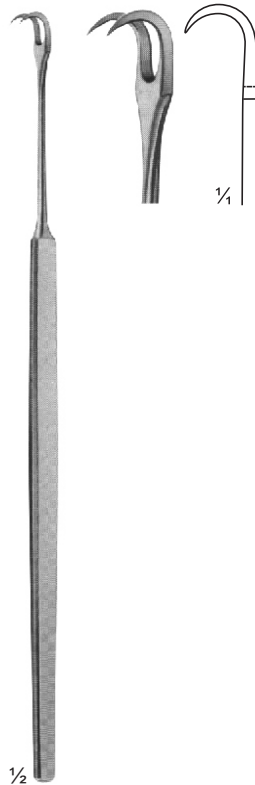

JJ-14-188
SIMON
Fistula hook
220 mm



JJ-14-189
LANGE
Fistula hook
230 mm

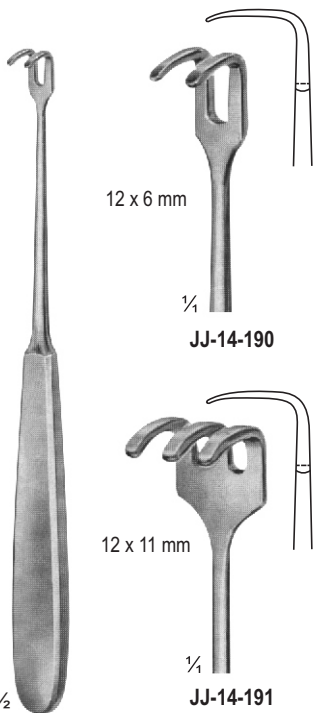

JJ-14-190 - JJ-14-191
Tendon hooks
175 mm

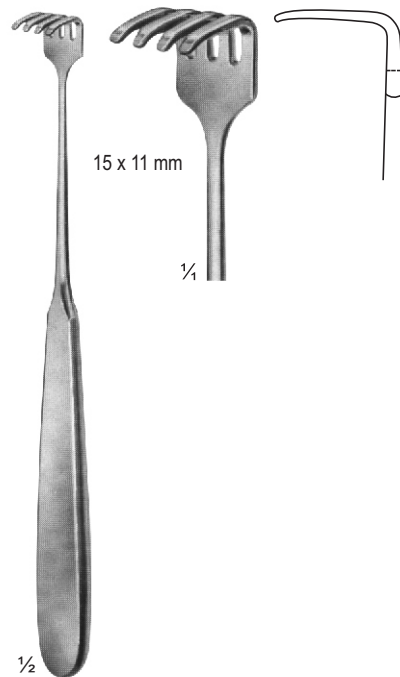

JJ-14-192
KLAPP
Tendon hooks
175 mm

WOUND AND VEIN RETRACTORS

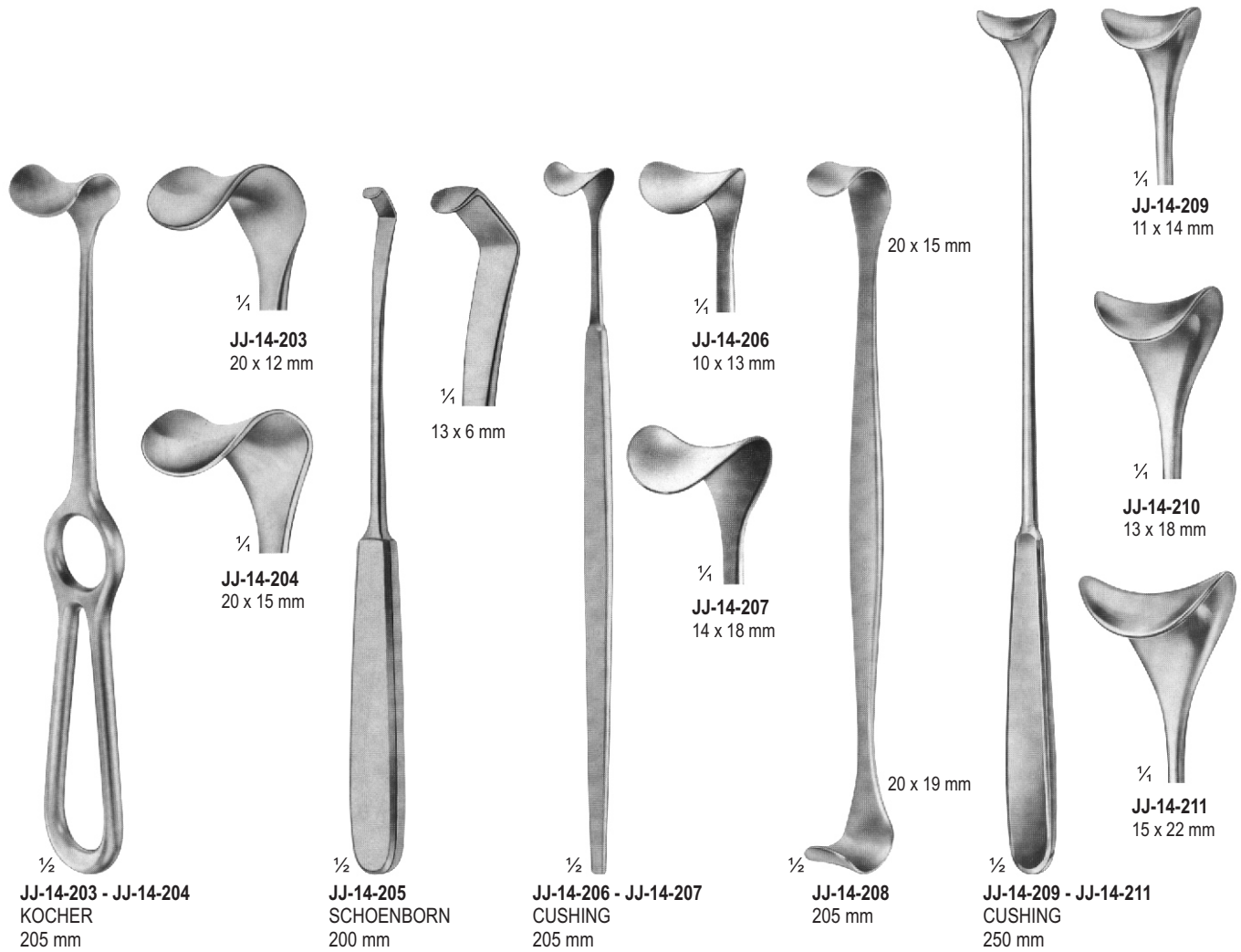
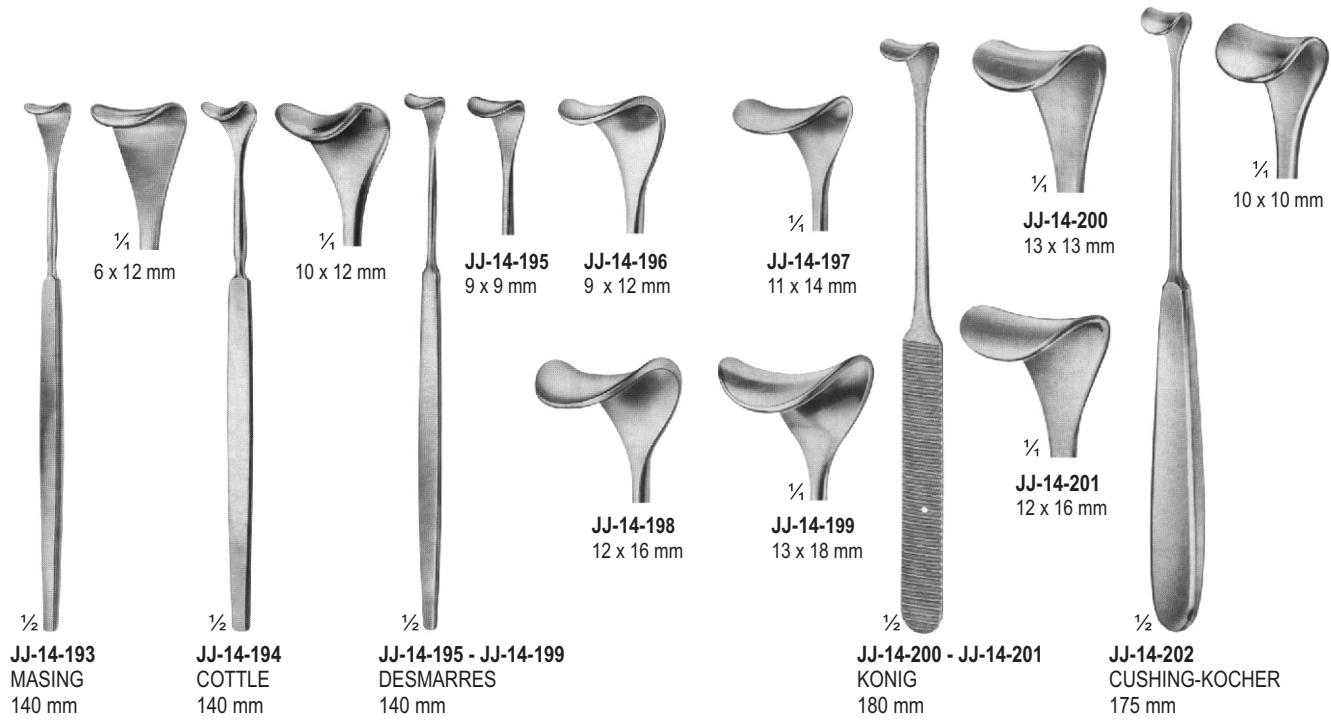

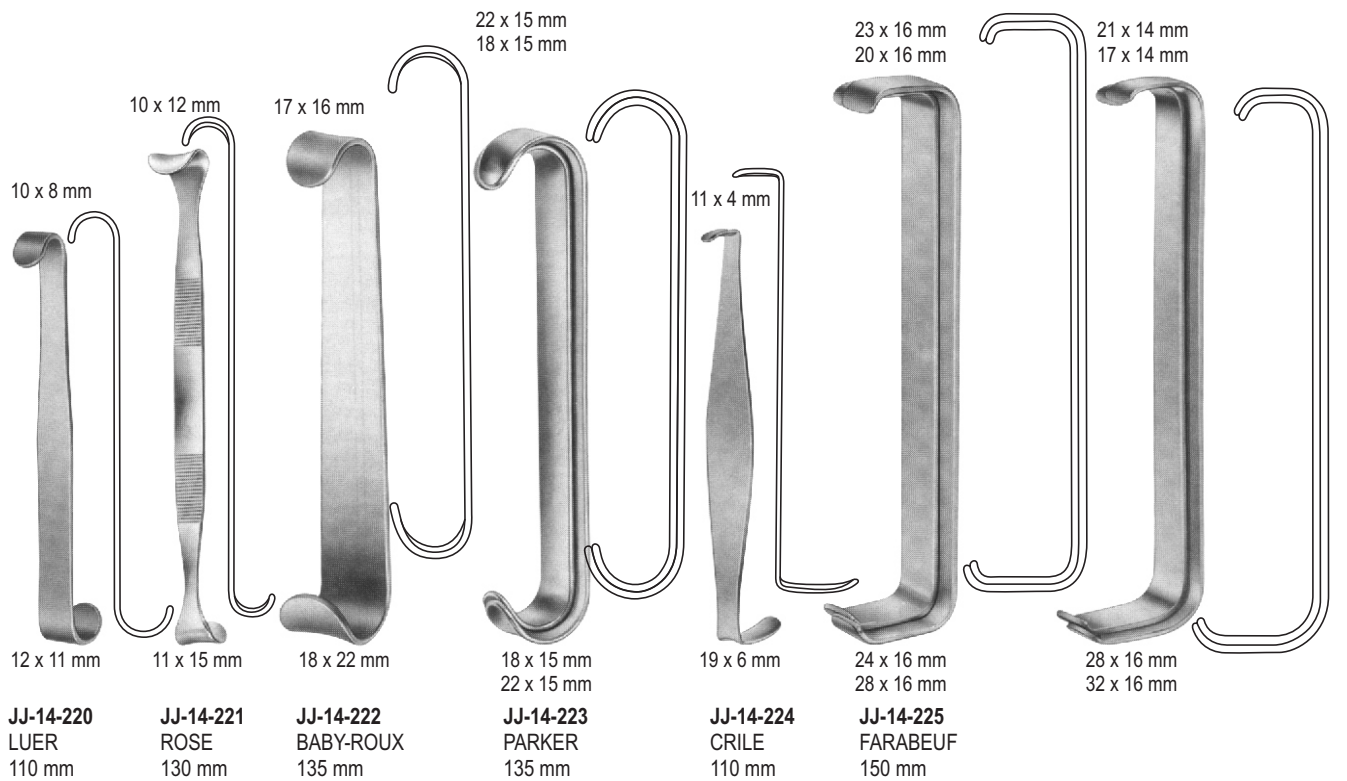
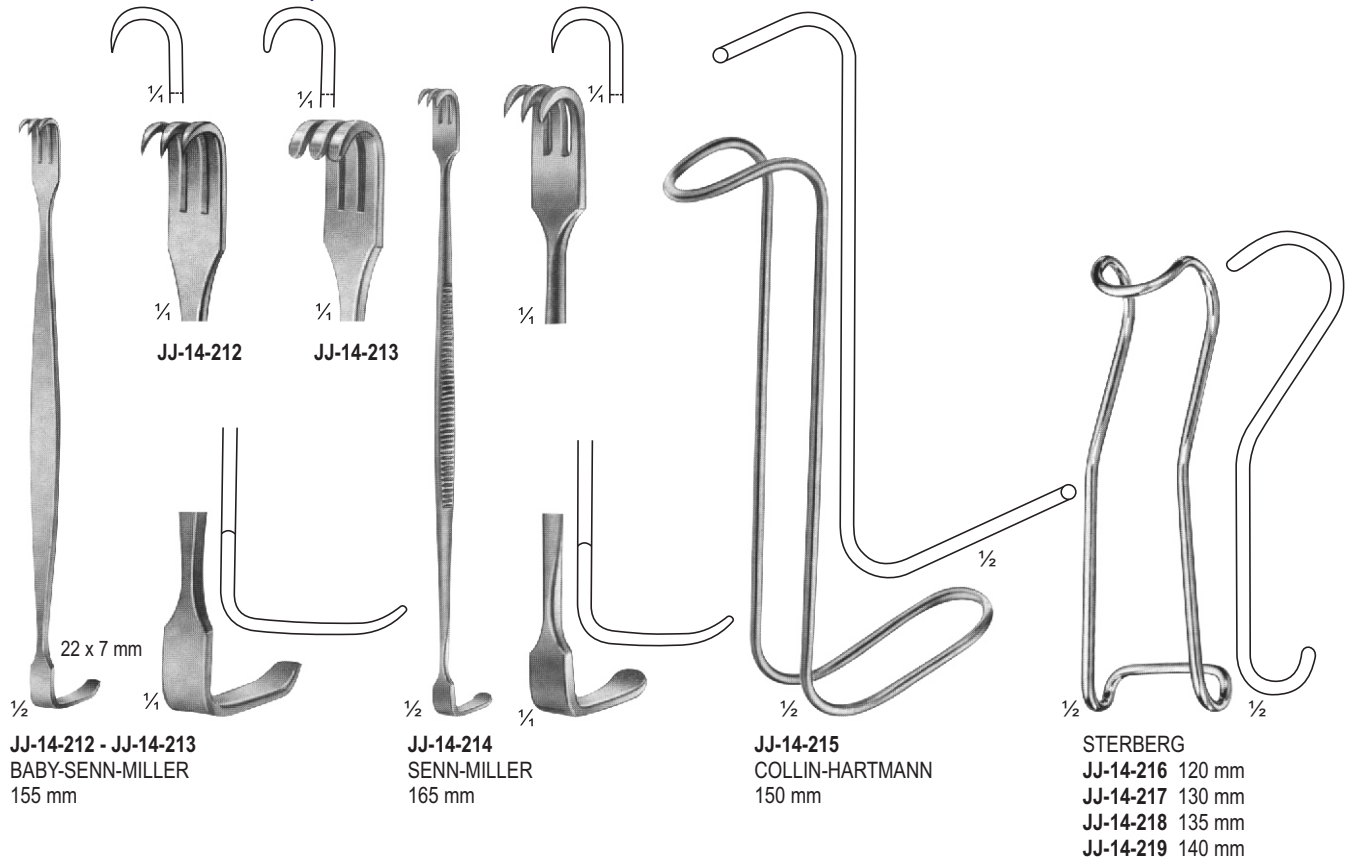

RETRACTORS

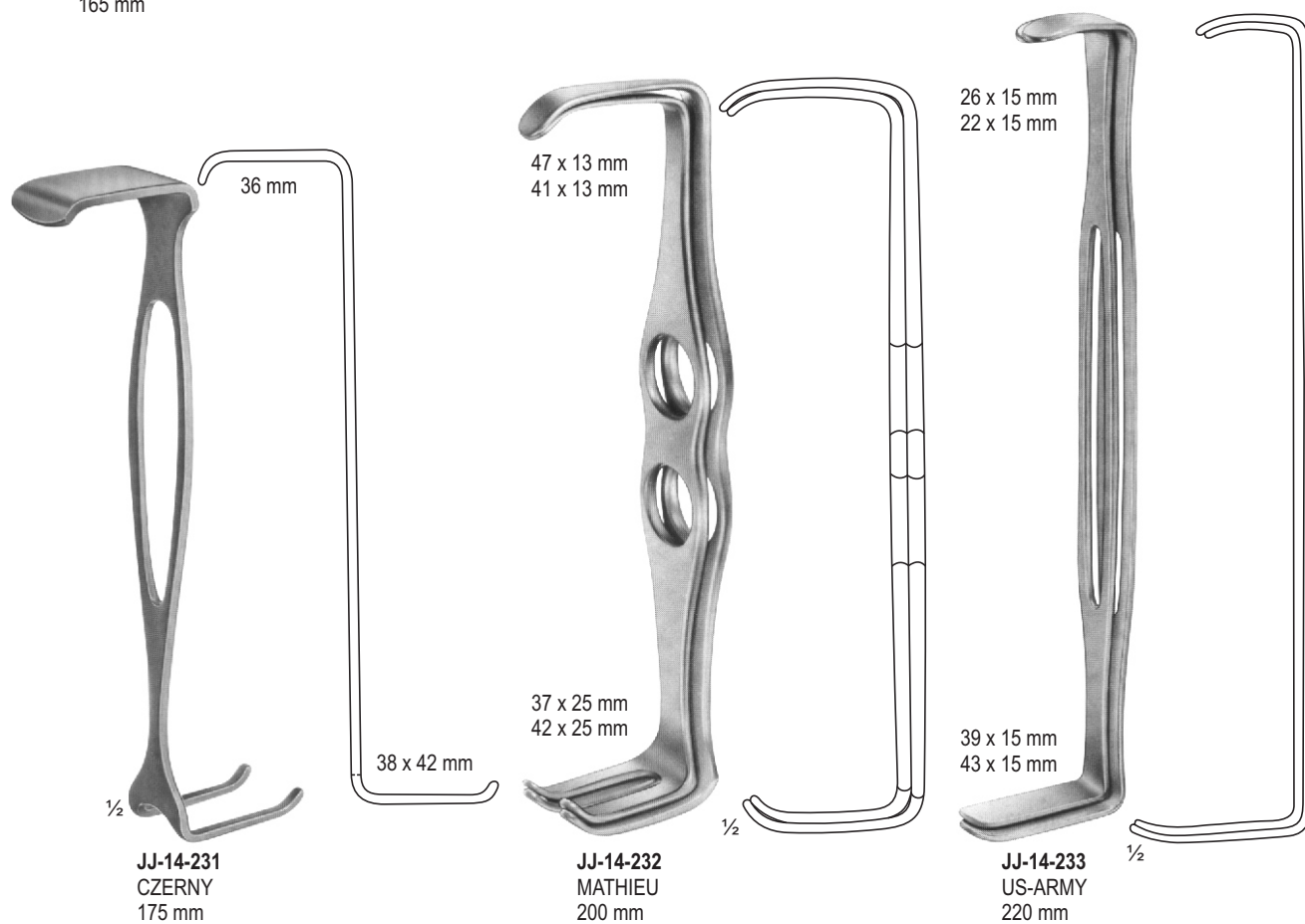
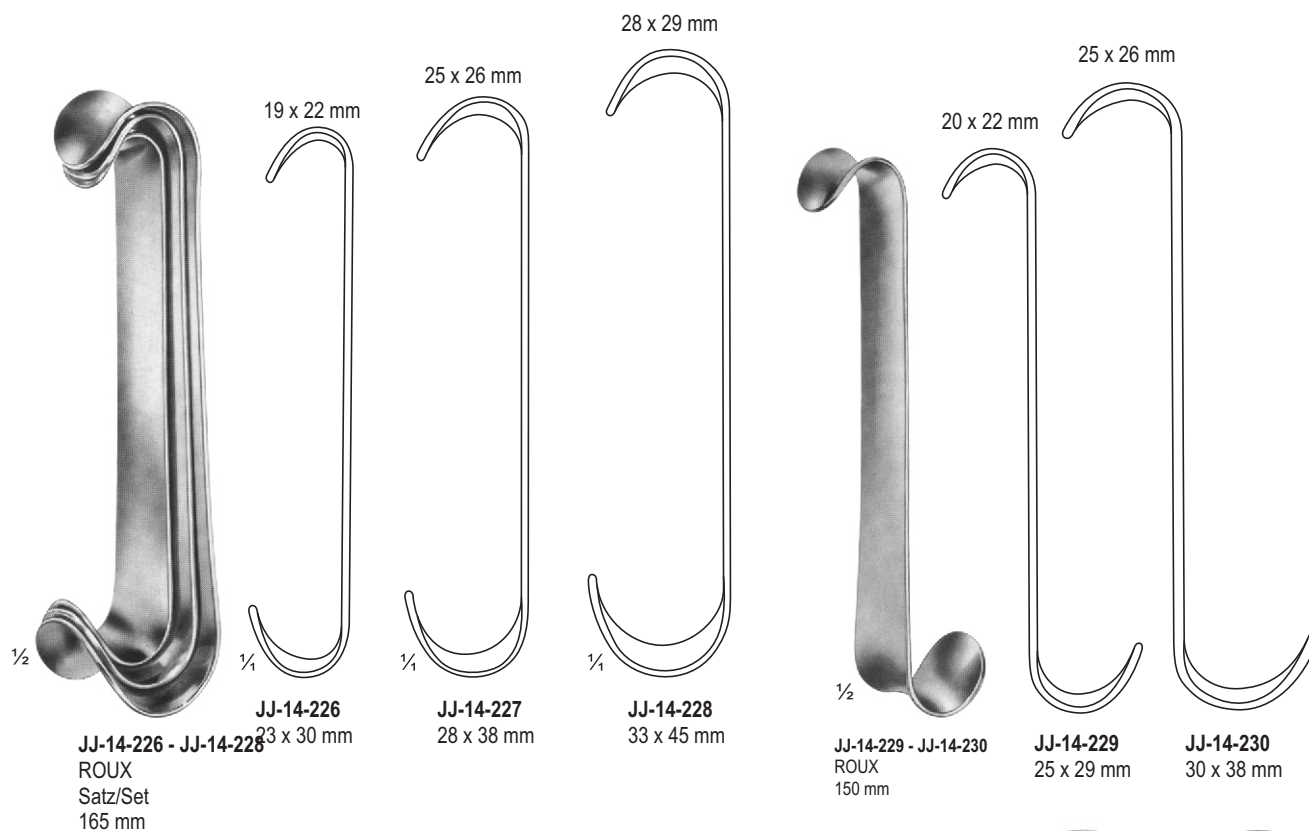



JJ-14-234
KOCHER
Sharp
205 mm

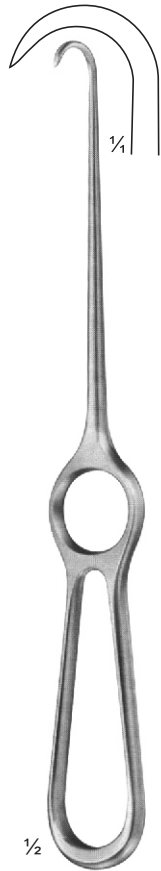

JJ-14-235
KOCHER
Sharp
220 mm



JJ-14-236
KOCHER
Blunt
220 mm



JJ-14-237
VOLKMANN
Sharp
220 mm

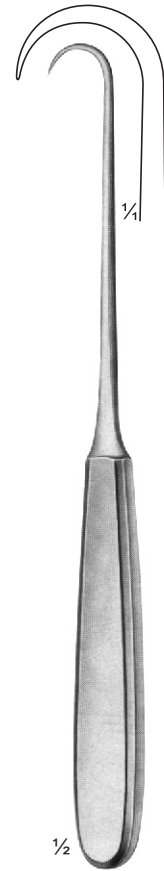

JJ-14-238
VOLKMANN
Sharp
220 mm



JJ-14-239 - JJ-14-246
VOLKMANN
225 mm

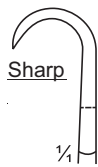

JJ-14-239
9 x 8 mm



JJ-14-240
9 x 13 mm



JJ-14-241
9 x 19 mm



JJ-14-242
9 x 29 mm

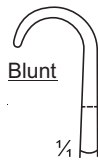

JJ-14-243
8,5 x 8 mm



JJ-14-244
8,5 x 13 mm



JJ-14-245
8,5 x 19 mm

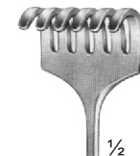

JJ-14-246
8,5 x 29 mm

RETRACTORS

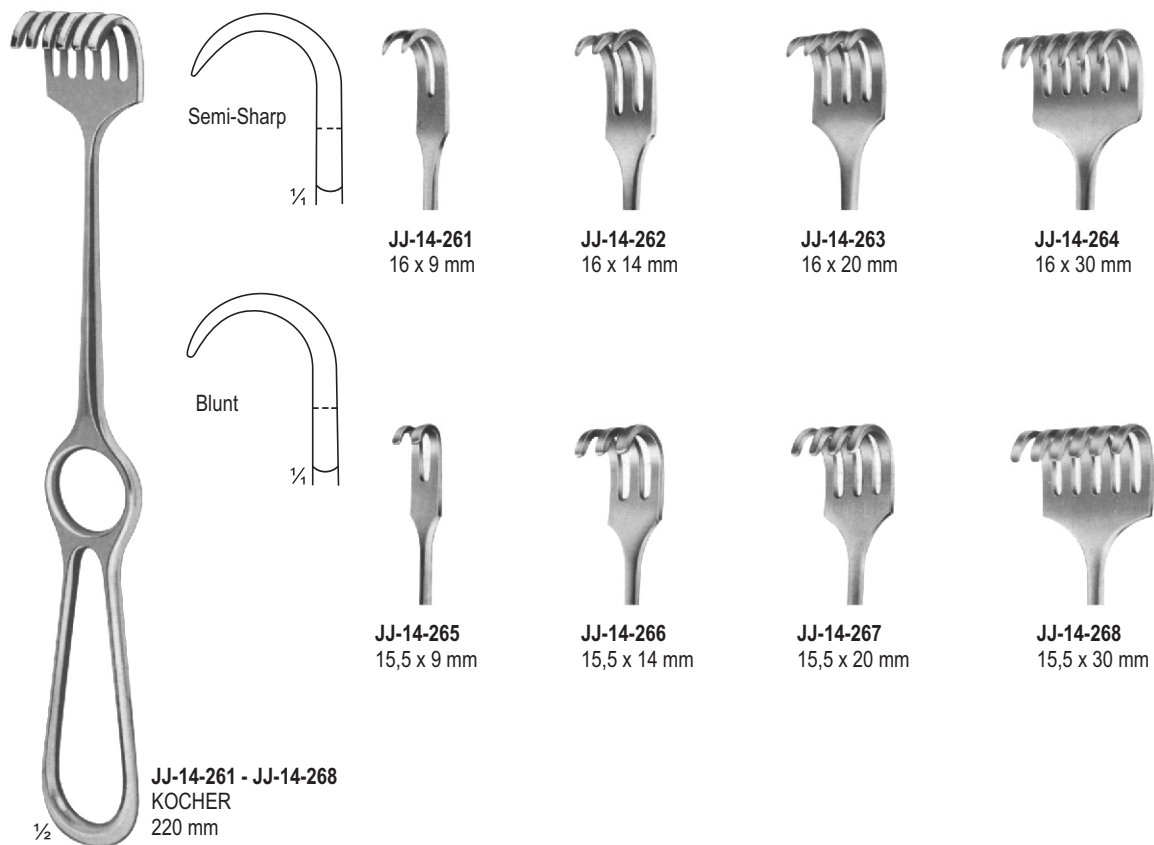
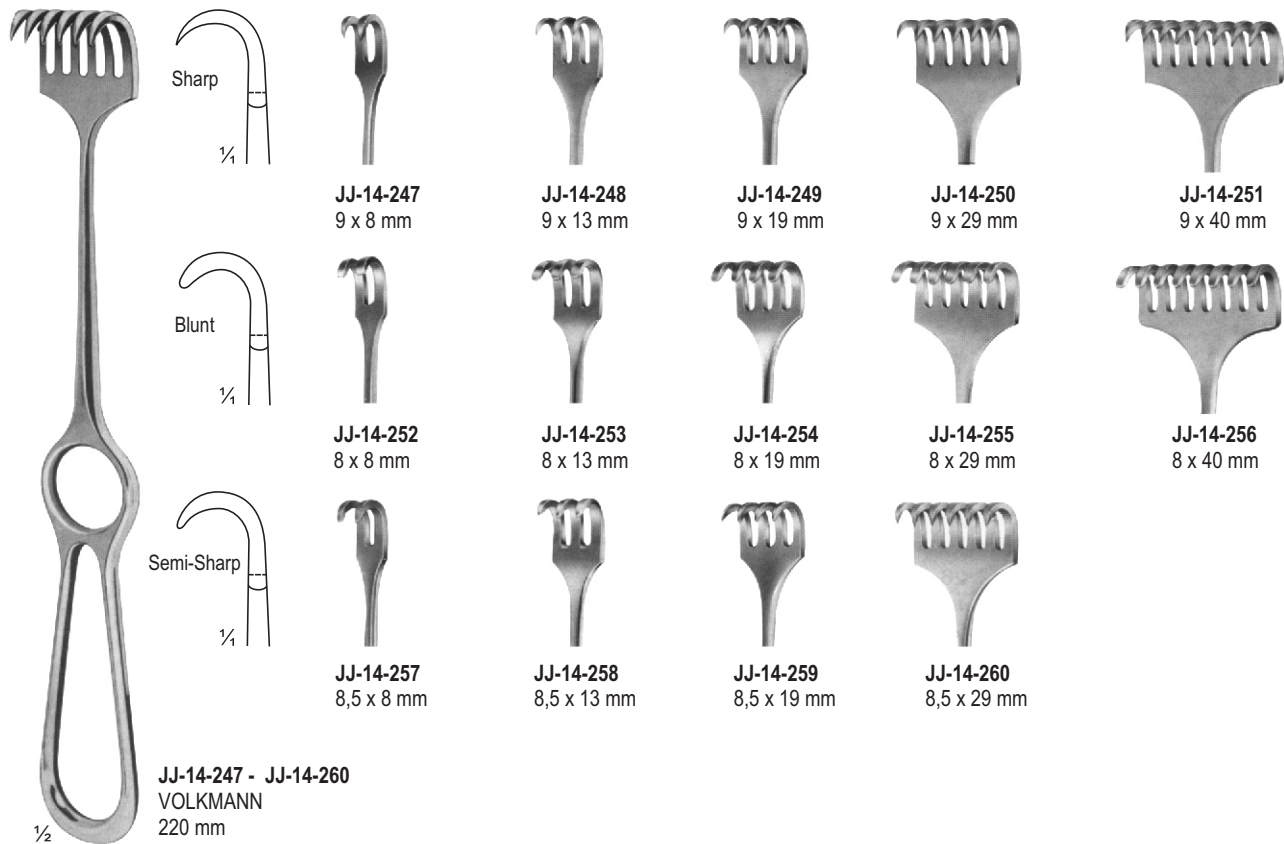



JJ-14-268 - JJ-14-270
KORTE
240 mm



JJ-14-269
8 Prongs, blunt



JJ-14-270
8 Prongs, sharp



JJ-14-271 - JJ-14-274
ISRAEL
255 mm

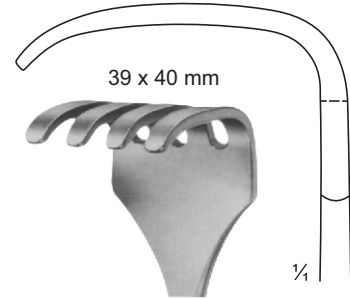

JJ-14-271
4 Prongs, blunt

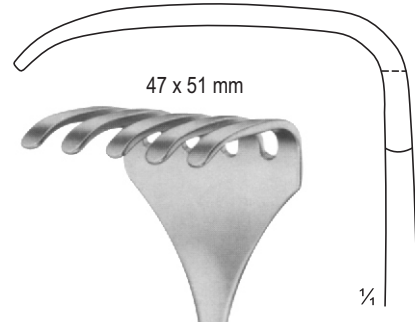

JJ-14-272
5 Prongs, blunt

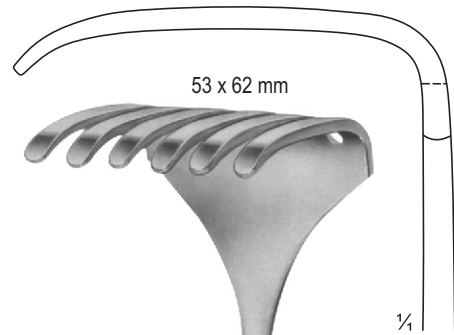

JJ-14-273
6 Prongs, blunt

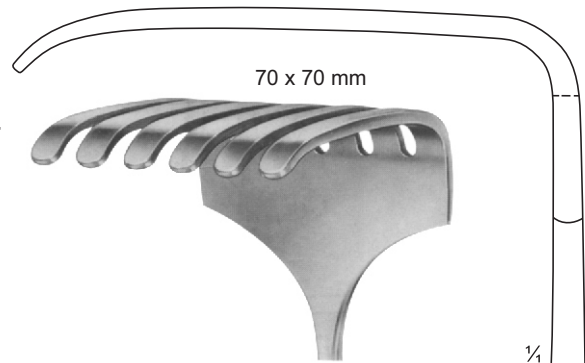

JJ-14-274
6 Prongs, blunt

RETRACTORS



JJ-14-275 - JJ-14-280
LANGENBECK
210 mm

JJ-14-275	28 x 10 mm
JJ-14-276	28 x 14 mm
JJ-14-277	33 x 14 mm
JJ-14-278	28 x 16 mm
JJ-14-279	40 x 10 mm
JJ-14-280	40 x 13 mm



JJ-14-281 - JJ-14-287
KOCHER-LANGENBECK
215 mm

JJ-14-281	25 x 6 mm
JJ-14-282	35 x 8 mm
JJ-14-283	35 x 11 mm
JJ-14-284	35 x 15 mm
JJ-14-285	41 x 11 mm
JJ-14-286	55 x 11 mm
JJ-14-287	70 x 14 mm

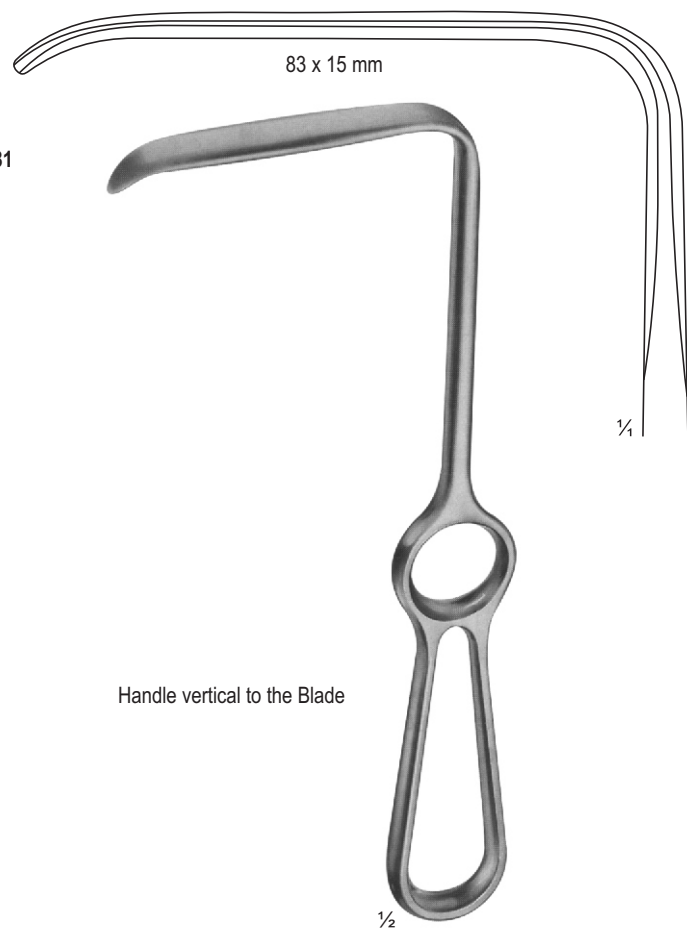

JJ-14-288
LANGENBECK
215 mm

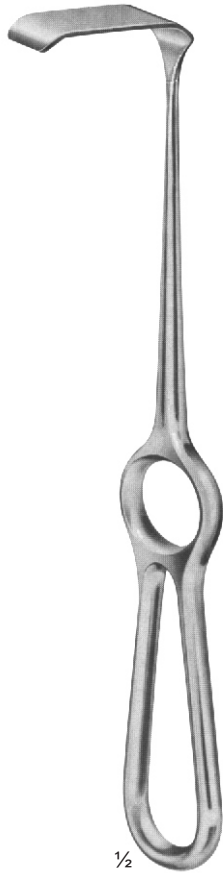

JJ-14-289 - JJ-14-293
KOCHER
230 mm

1/2

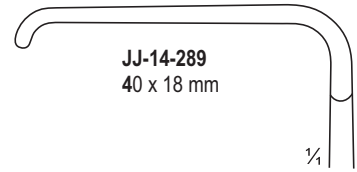

JJ-14-289
40 x 18 mm

1/4

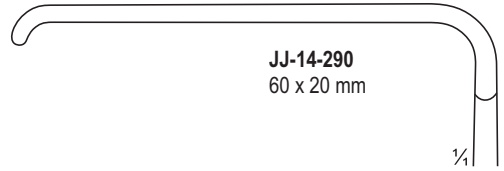

JJ-14-290
60 x 20 mm

1/4

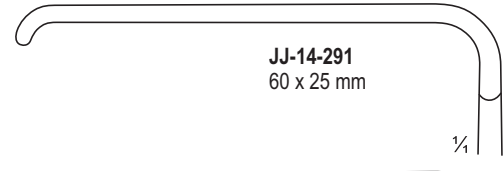

JJ-14-291
60 x 25 mm

1/4

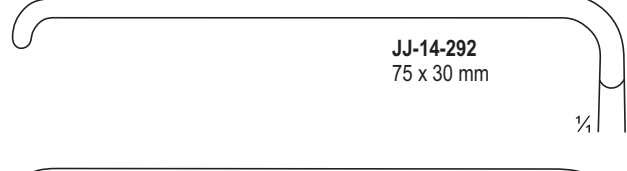

JJ-14-292
75 x 30 mm

1/4

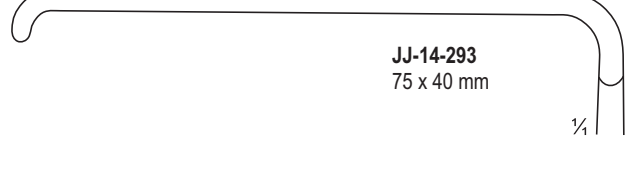

JJ-14-293
75 x 40 mm

1/4

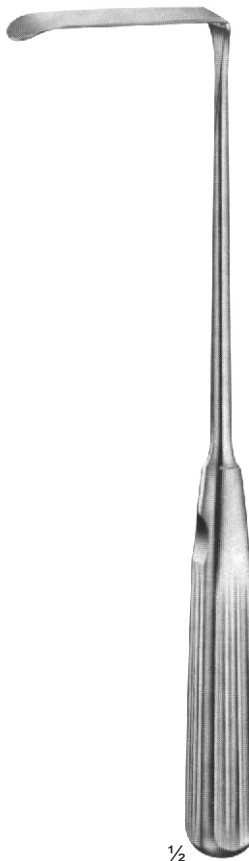

JJ-14-294 - JJ-14-296
SAUERBRUCH
225 mm

1/2

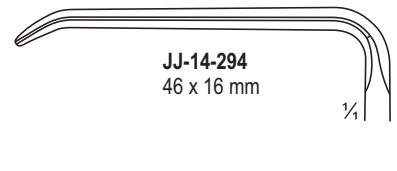

JJ-14-294
46 x 16 mm

1/4

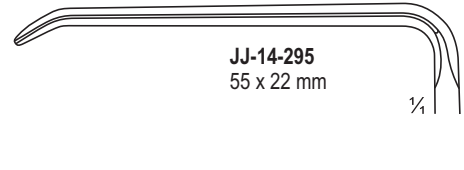

JJ-14-295
55 x 22 mm

1/4

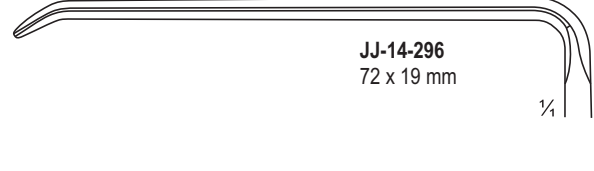

JJ-14-296
72 x 19 mm

1/4

RETRACTORS



1/2
JJ-14-297 - JJ-14-299
 MIDDELDORPF



1/2
JJ-14-297
 15 x 15 mm
 220 mm



1/2
JJ-14-298
 20 x 22 mm
 215 mm



1/2
JJ-14-299
 28 x 28 mm
 235 mm

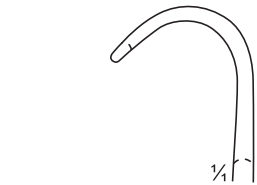

1/4

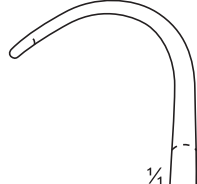

1/4

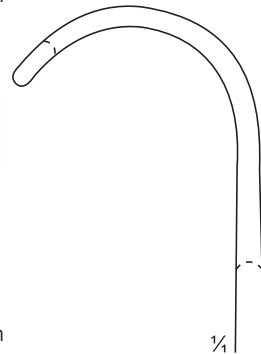

1/4



1/2

JJ-14-300
 BUCHS
 205 mm

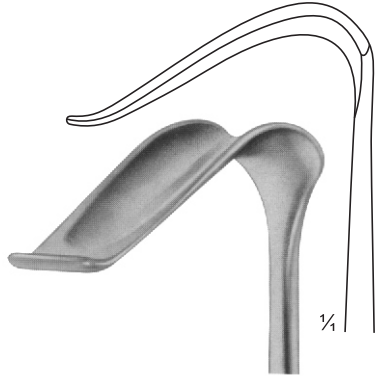

38 x 18 mm

1/4

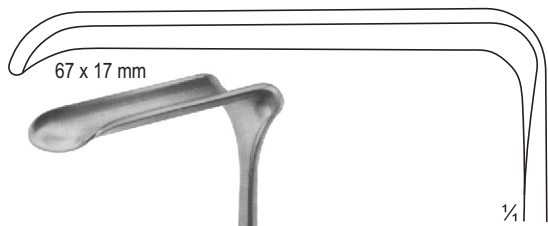

67 x 17 mm

1/4



1/2

JJ-14-301
 CASPAR
 210 mm



1/2

JJ-14-302
 KOCHER
 230 mm

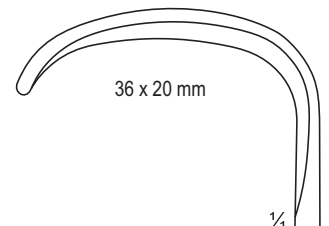

36 x 20 mm

1/4



1/2

JJ-14-303 - JJ-14-308
HOSEL
250 mm

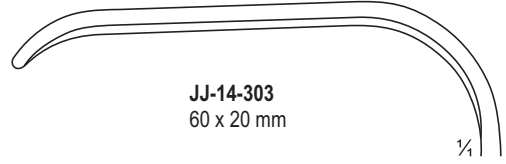

JJ-14-303
60 x 20 mm

1/4

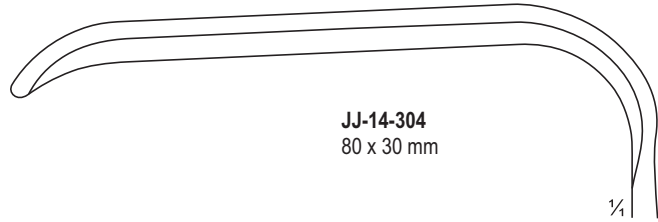

JJ-14-304
80 x 30 mm

1/4

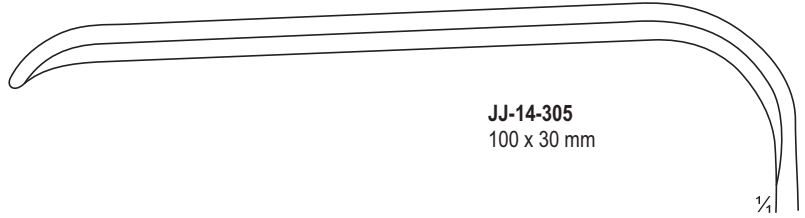

JJ-14-305
100 x 30 mm

1/4

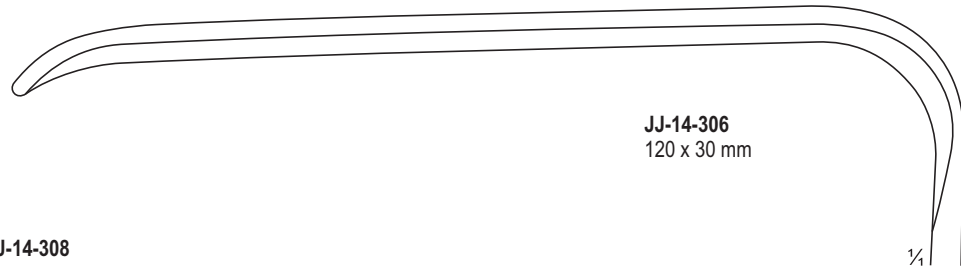

JJ-14-306
120 x 30 mm

1/4

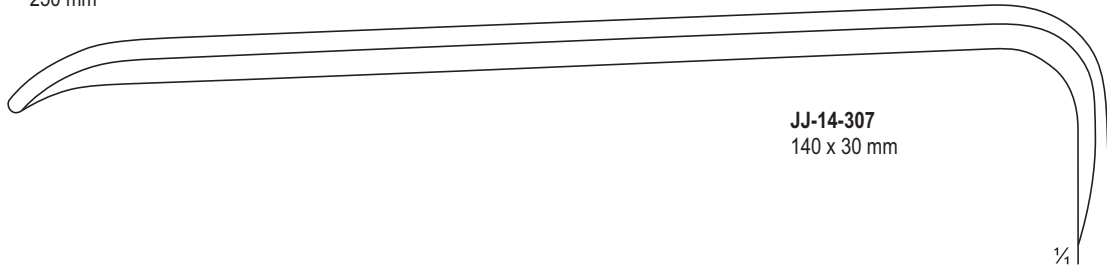

JJ-14-307
140 x 30 mm

1/4

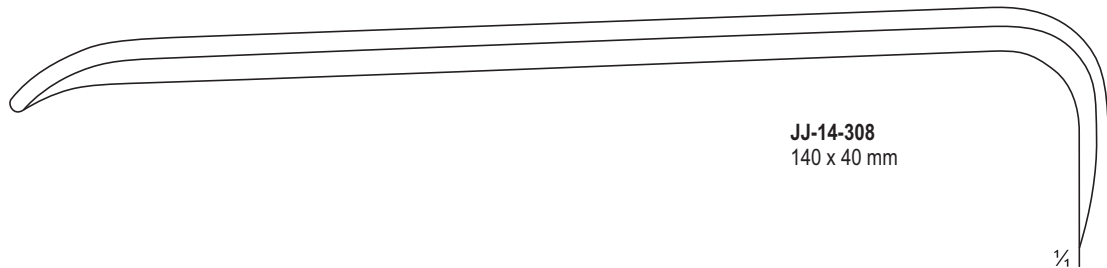

JJ-14-308
140 x 40 mm

1/4

RETRACTORS

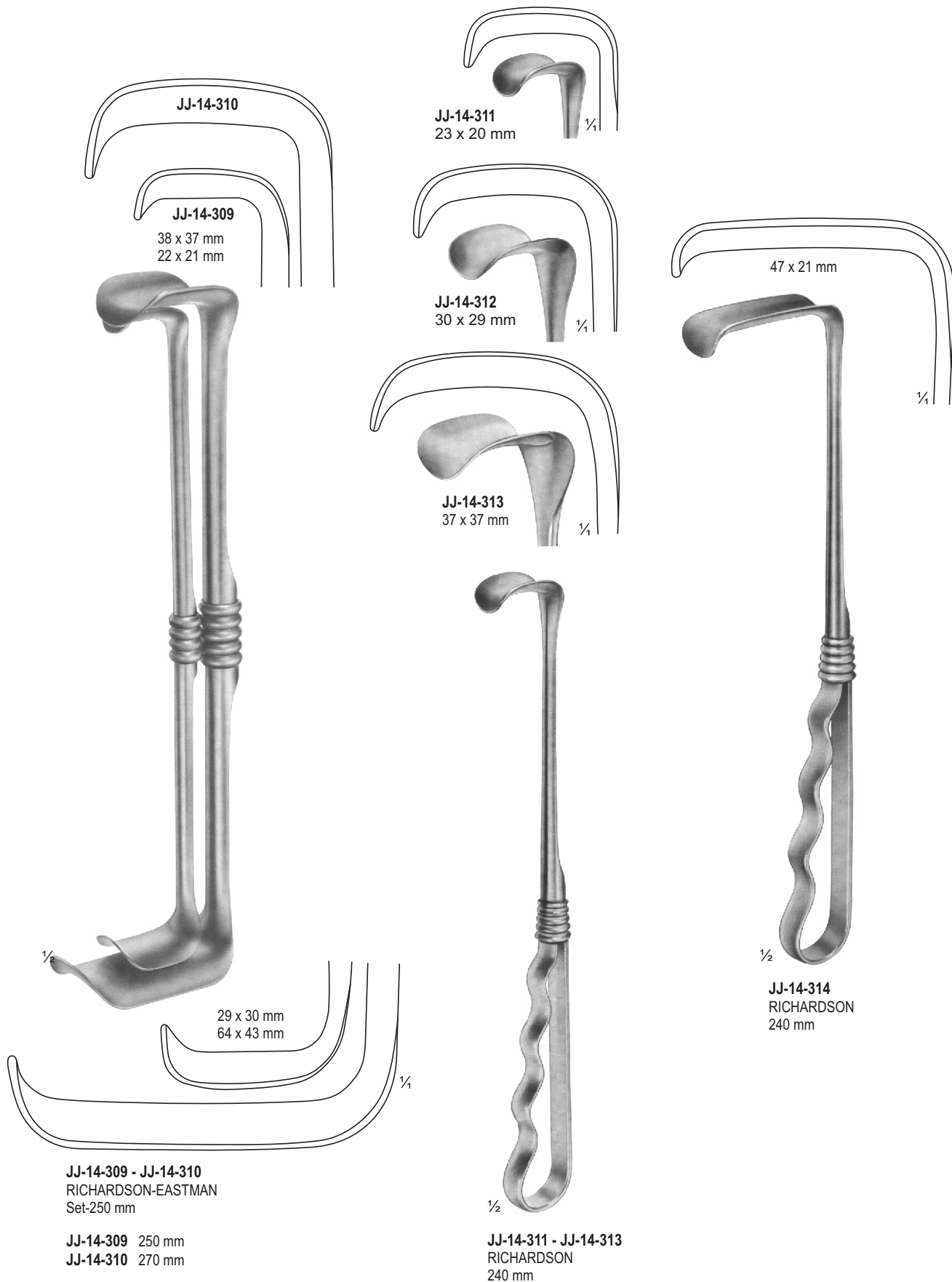

JJ-14-309 - JJ-14-310
RICHARDSON-EASTMAN
Set-250 mm

JJ-14-309 250 mm
JJ-14-310 270 mm

JJ-14-311 - JJ-14-313
RICHARDSON
240 mm

JJ-14-314
RICHARDSON
240 mm

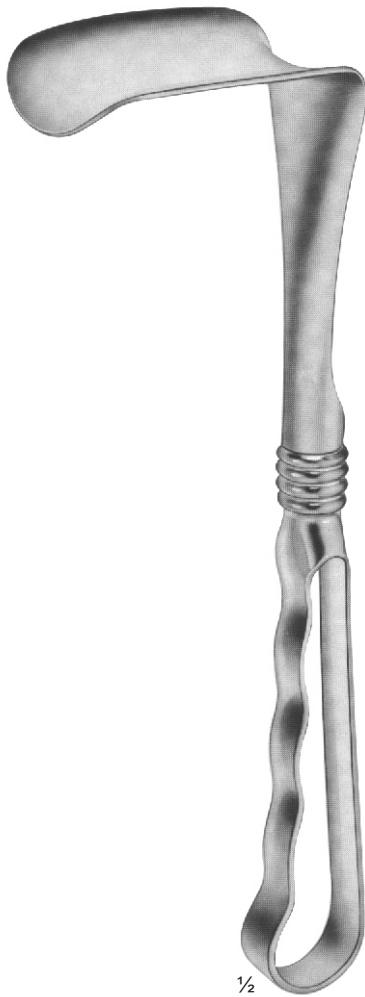
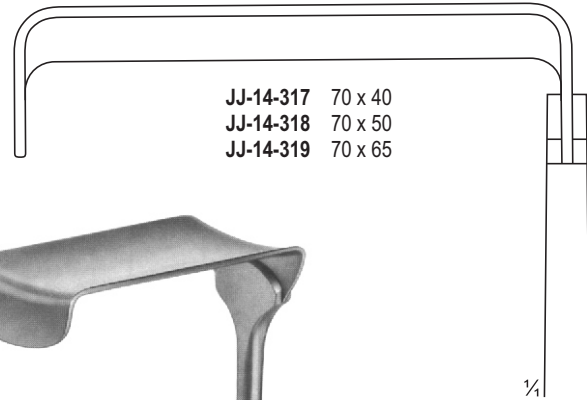
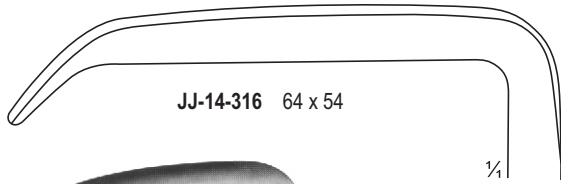
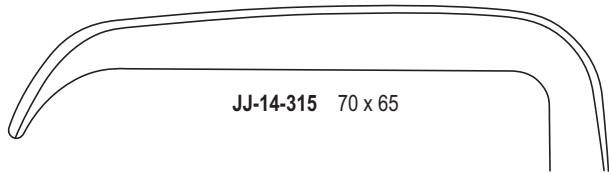

JJ-14-315 - JJ-14-316
KELLY
260 mm

JJ-14-317 - JJ-14-319
MORRIS
245 mm

RETRACTORS FOR DEEP SURGERY

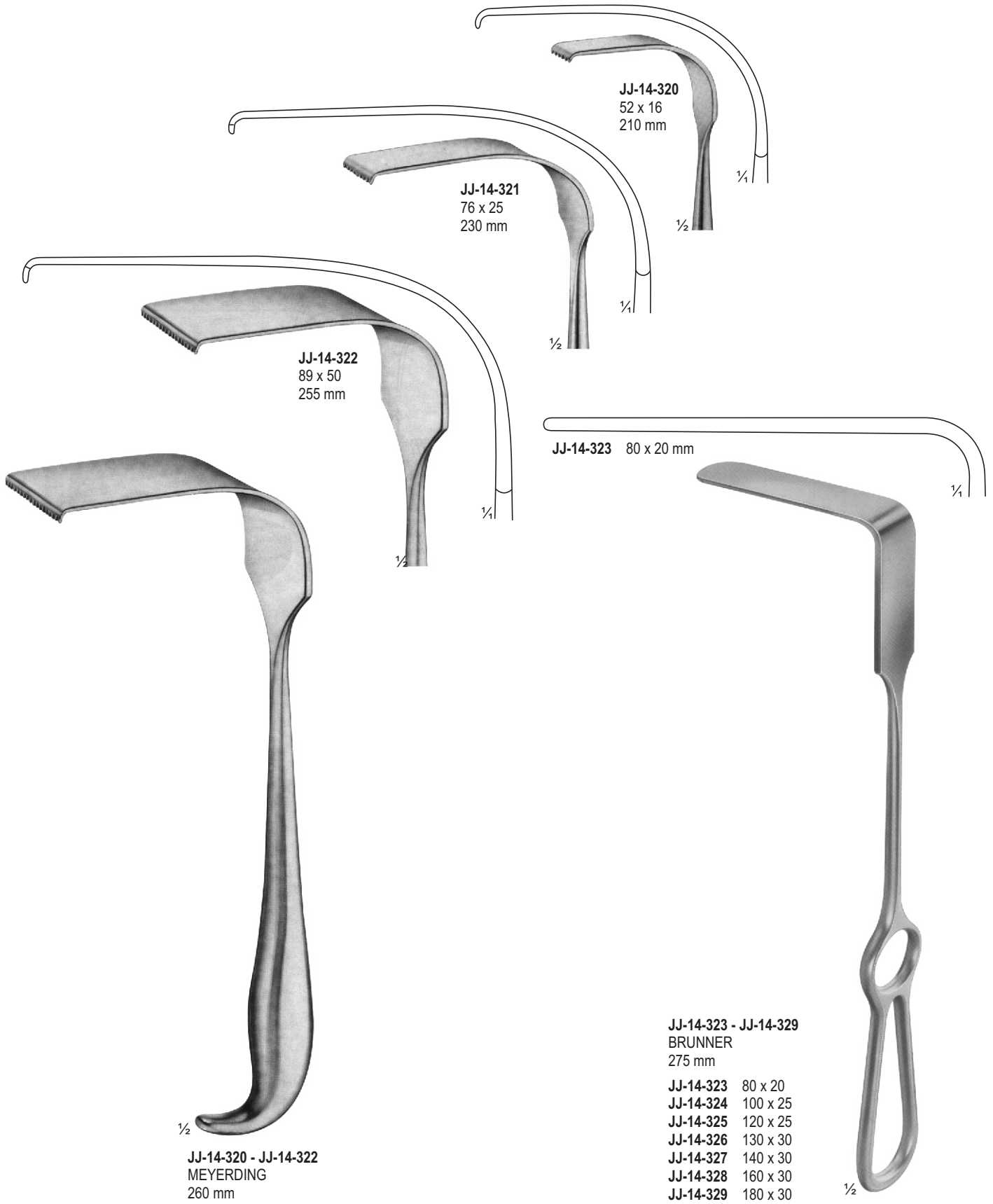

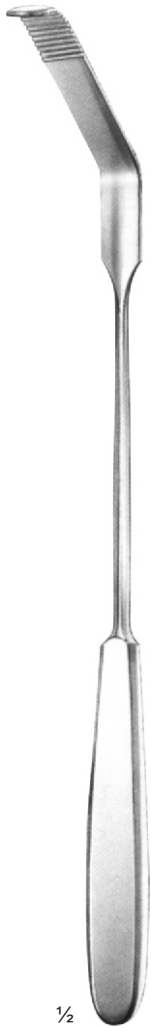

1/2

ZENKER
JJ-14-330 - JJ-14-335

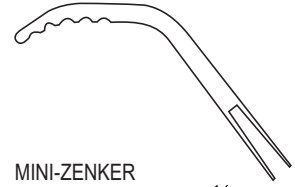

MINI-ZENKER
JJ-14-330
180 mm
10 X 3 mm

1/4

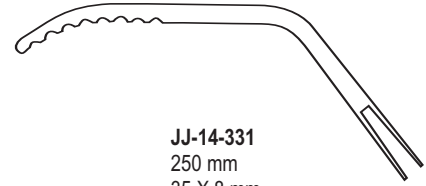

JJ-14-331
250 mm
35 X 8 mm

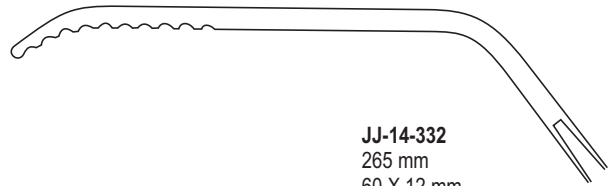

JJ-14-332
265 mm
60 X 12 mm

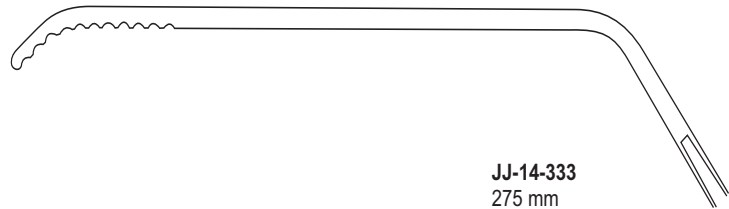

JJ-14-333
275 mm
75 X 12 mm

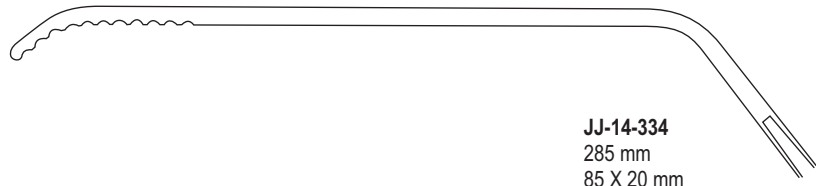

JJ-14-334
285 mm
85 X 20 mm

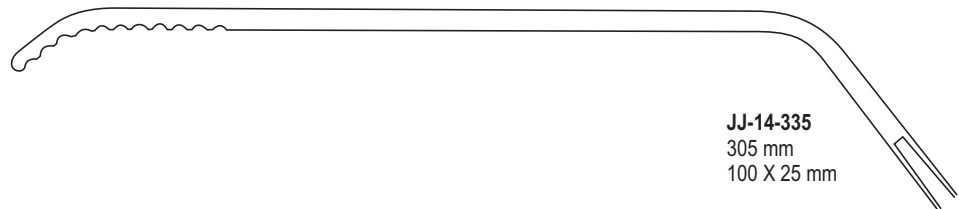

JJ-14-335
305 mm
100 X 25 mm



HOSEL
JJ-14-336 - JJ-14-341
250 mm

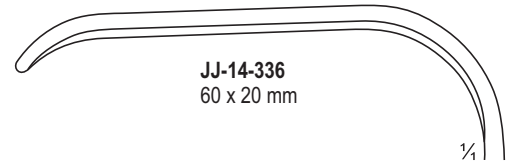

JJ-14-336
60 x 20 mm

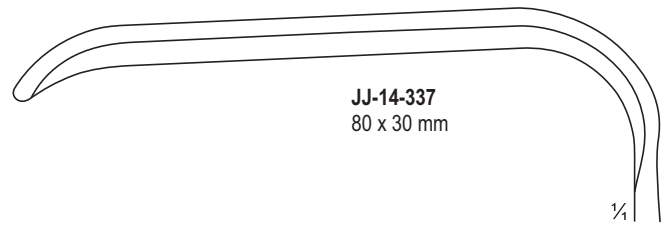

JJ-14-337
80 x 30 mm

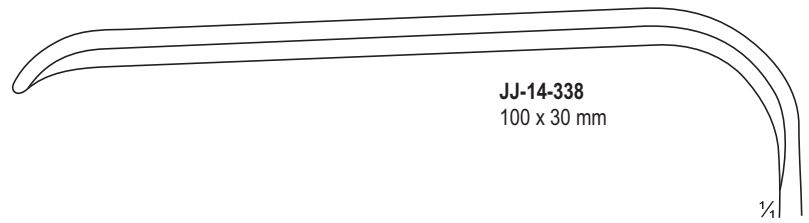

JJ-14-338
100 x 30 mm

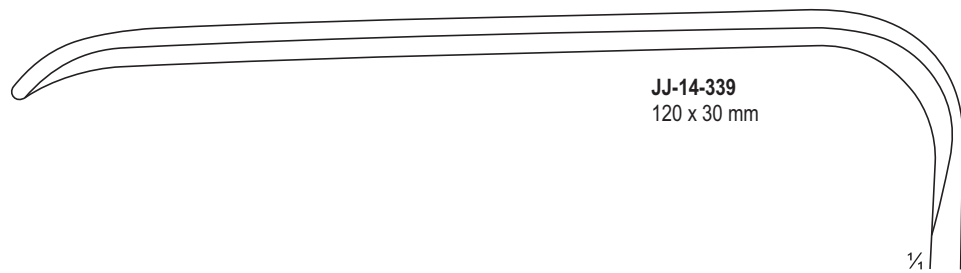

JJ-14-339
120 x 30 mm

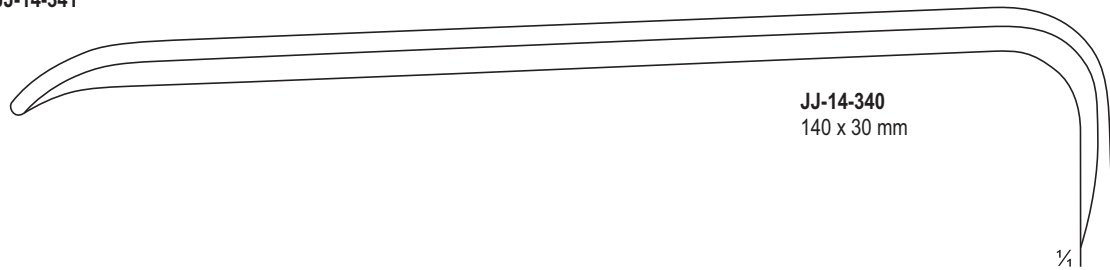

JJ-14-340
140 x 30 mm

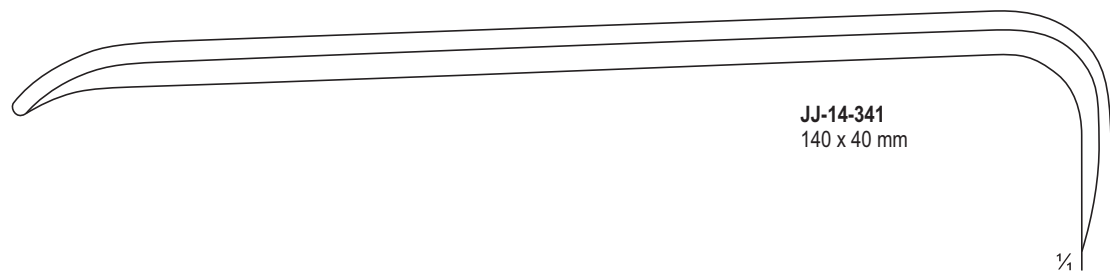

JJ-14-341
140 x 40 mm



HÖSEL
JJ-14-342 - JJ-14-347
260 mm

1/2

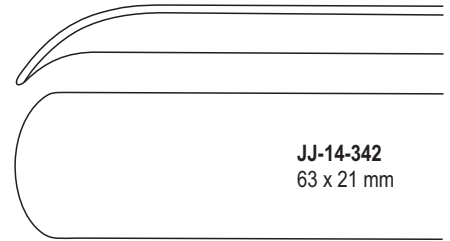

JJ-14-342
63 x 21 mm

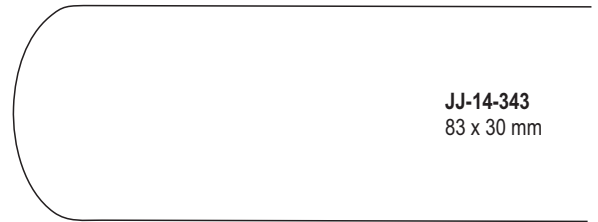

JJ-14-343
83 x 30 mm

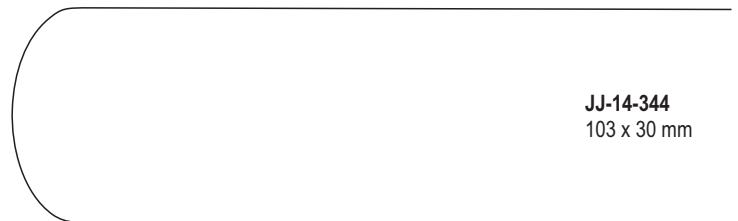

JJ-14-344
103 x 30 mm

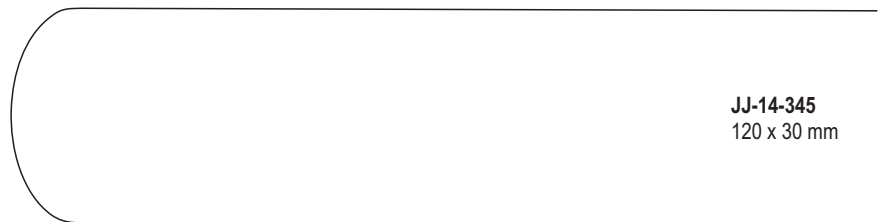

JJ-14-345
120 x 30 mm

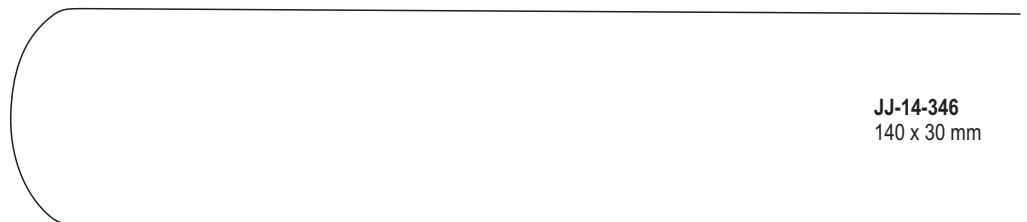

JJ-14-346
140 x 30 mm

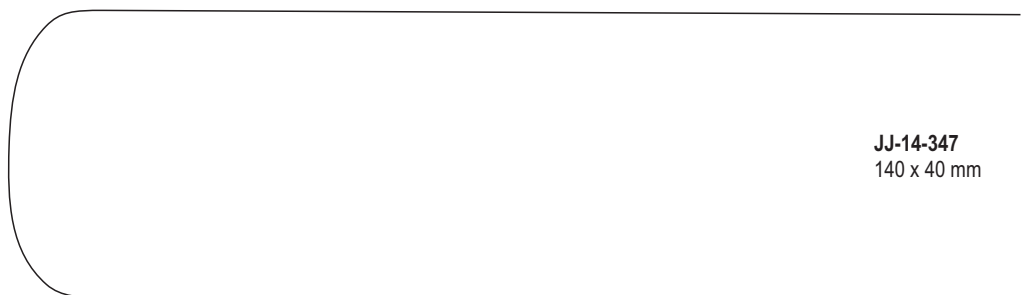

JJ-14-347
140 x 40 mm

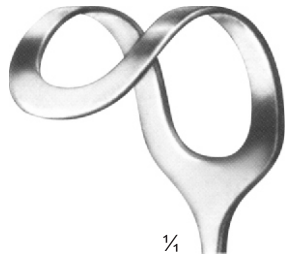

1/4

JJ-14-348
270 mm
43 X 45 mm

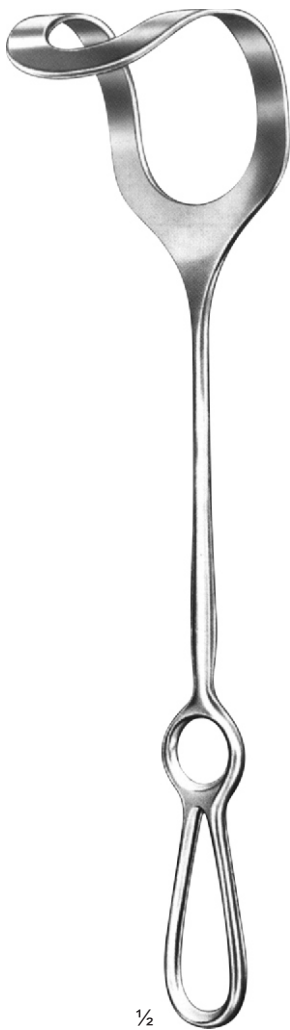
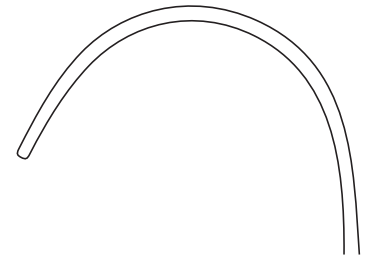

1/2

MIDDELDORPF
JJ-14-348 - JJ-14-350



JJ-14-349
270 mm
52 X 50 mm

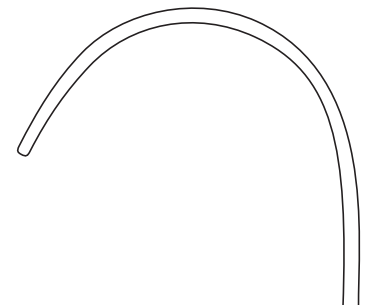

JJ-14-350
280 mm
52 X 70 mm

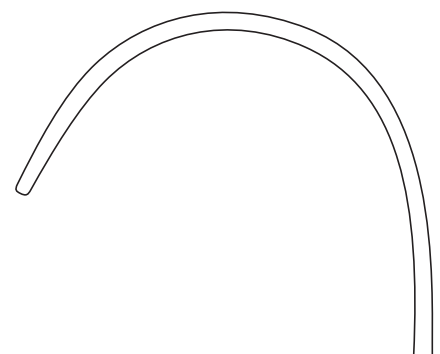

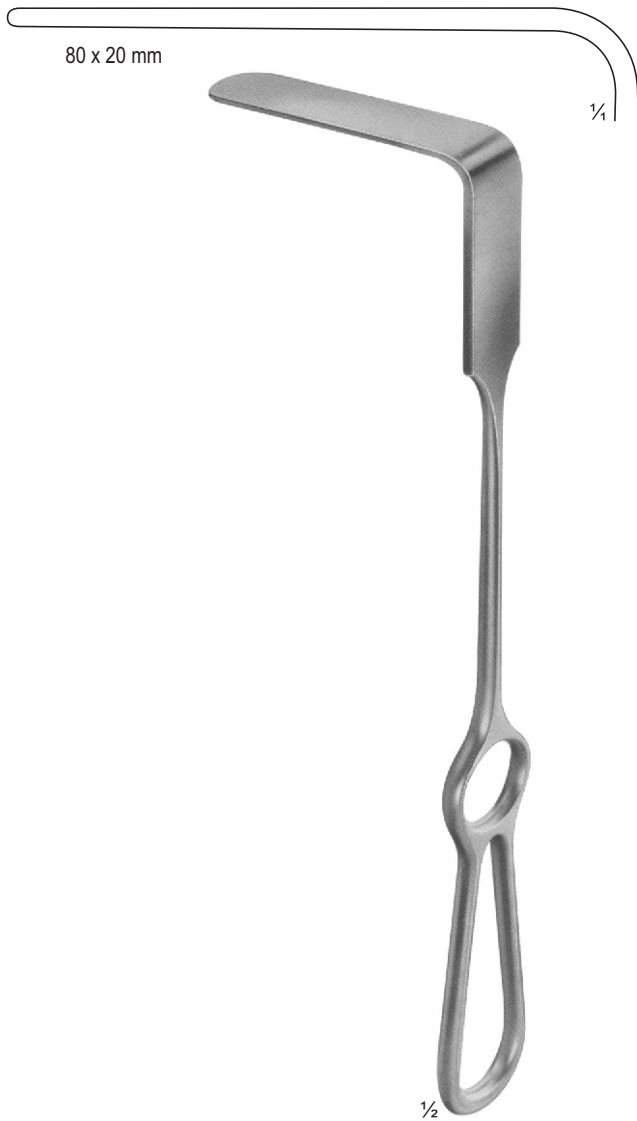

BRUNNER
JJ-14-351 - JJ-14-357
275 mm

- JJ-14-351 80 x 20
- JJ-14-352 100 x 25
- JJ-14-353 120 x 25
- JJ-14-354 130 x 30
- JJ-14-355 140 x 30
- JJ-14-356 160 x 30
- JJ-14-357 180 x 30

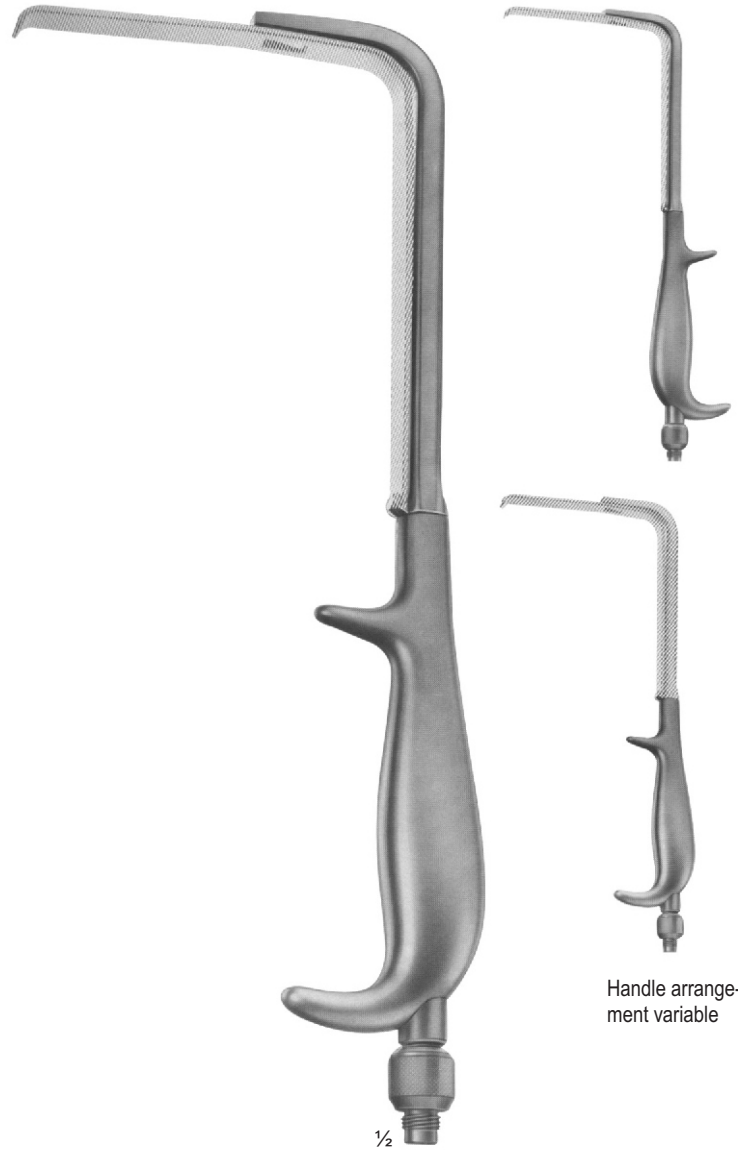

JJ-14-358
Handle with cold light carrier for retractor blades.
280 mm

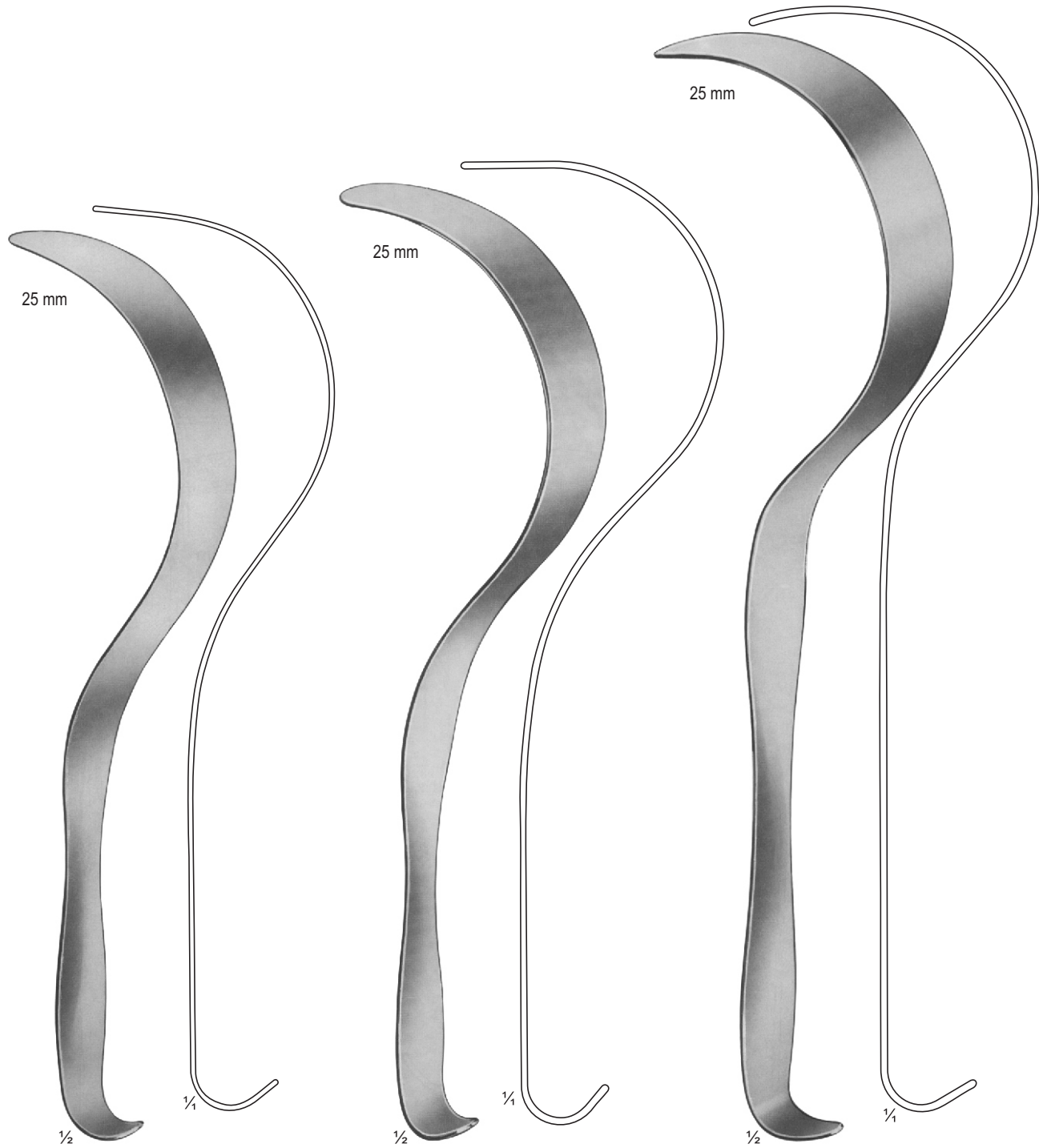

JJ-14-359
DEAVER
300 mm
Fig. 1

JJ-14-360
DEAVER
315 mm
Fig. 2

JJ-14-361
DEAVER
365 mm
Fig. 2



Fig. 3
DEEVER
JJ-14-362
300 mm

Fig. 4
DEEVER
JJ-14-363
310 mm

Fig. 5
DEEVER
JJ-14-364
320 mm

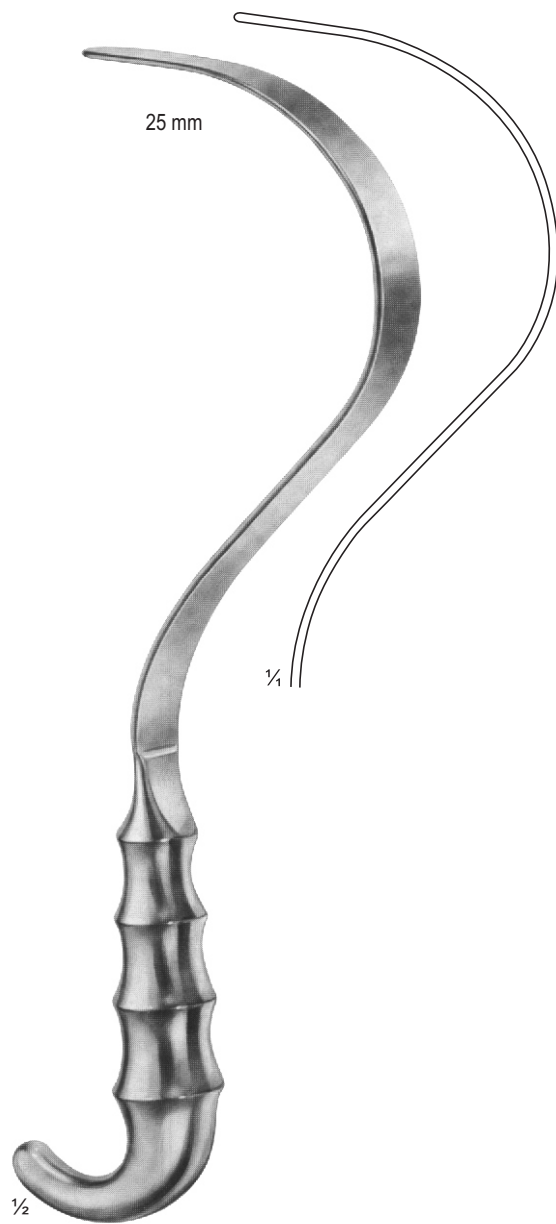

JJ-14-365
DEAVER
310 mm
Fig. 1

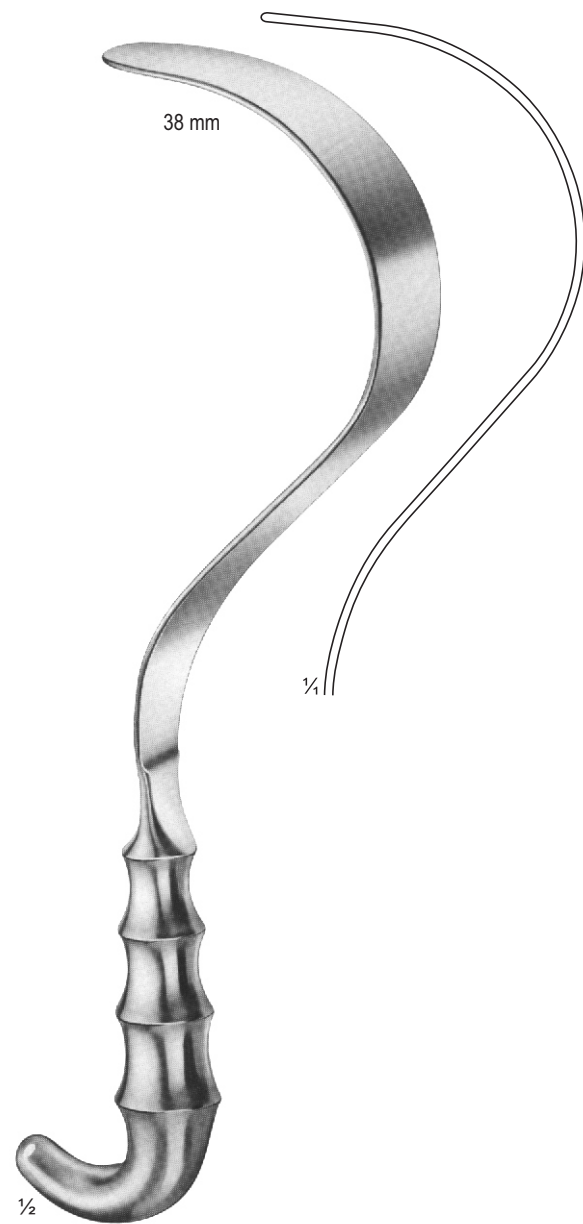

JJ-14-366
DEAVER
310 mm
Fig. 3



COOLEY
JJ-14-367
250 mm
Right
48 X 48 mm



COOLEY
JJ-14-368
250 mm
Right, Serrated
48 X 48 mm



COOLEY
JJ-14-369
275 mm
Left
30 X 48 mm

ABDOMINAL RETRACTORS

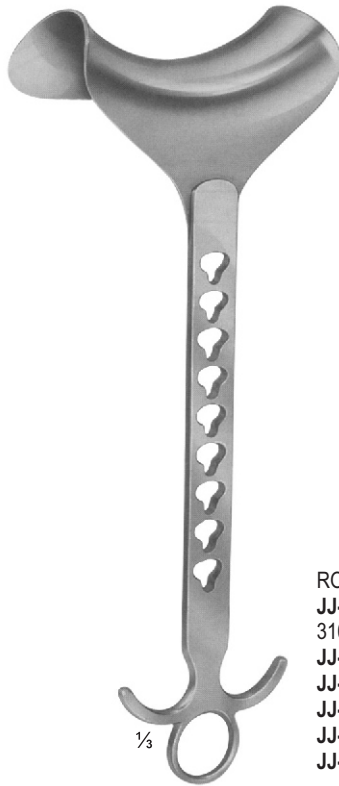

ROCHARD
JJ-14-370 - JJ-14-374
 310 mm
JJ-14-370 48 x 90 mm
JJ-14-371 48 x 105 mm
JJ-14-372 48 x 120 mm
JJ-14-373 48 x 135 mm
JJ-14-374 48 x 155 mm



JJ-14-375



DOYEN
JJ-14-376 - JJ-14-379
 280 mm
JJ-14-376 48 x 90 mm
JJ-14-377 48 x 105 mm
JJ-14-378 48 x 120 mm
JJ-14-379 48 x 135 mm



DOYEN-CHILD
JJ-14-380
 Fixation device
 220 mm

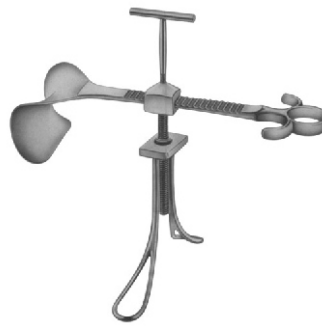

JJ-14-381
 Chain with
 weight (747 / 645g)
 790 mm



SENN-GREEN
JJ-14-382 - JJ-14-383
160 mm



Fig. 1
JJ-14-382
20 X 6 mm



Fig. 2
JJ-14-383
10 X 6 mm



RAGNELL-DAVIS
JJ-14-384
150 mm



¼
8 X 4.5 mm

15 X 5.5 mm



CUSHING
JJ-14-385
205 mm

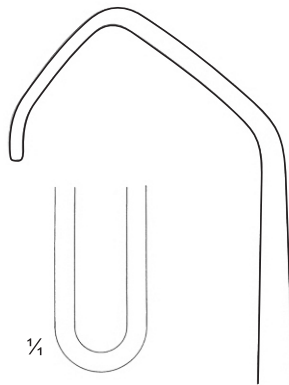

¼

19 x 15 mm
19 x 15 mm



22 x 15 mm
22 x 15 mm

PARKER
JJ-14-386
140 mm

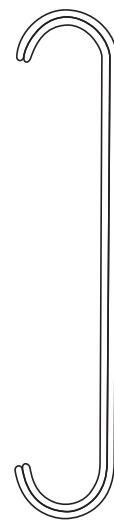

RETRACTORS FOR DEEP SURGERY

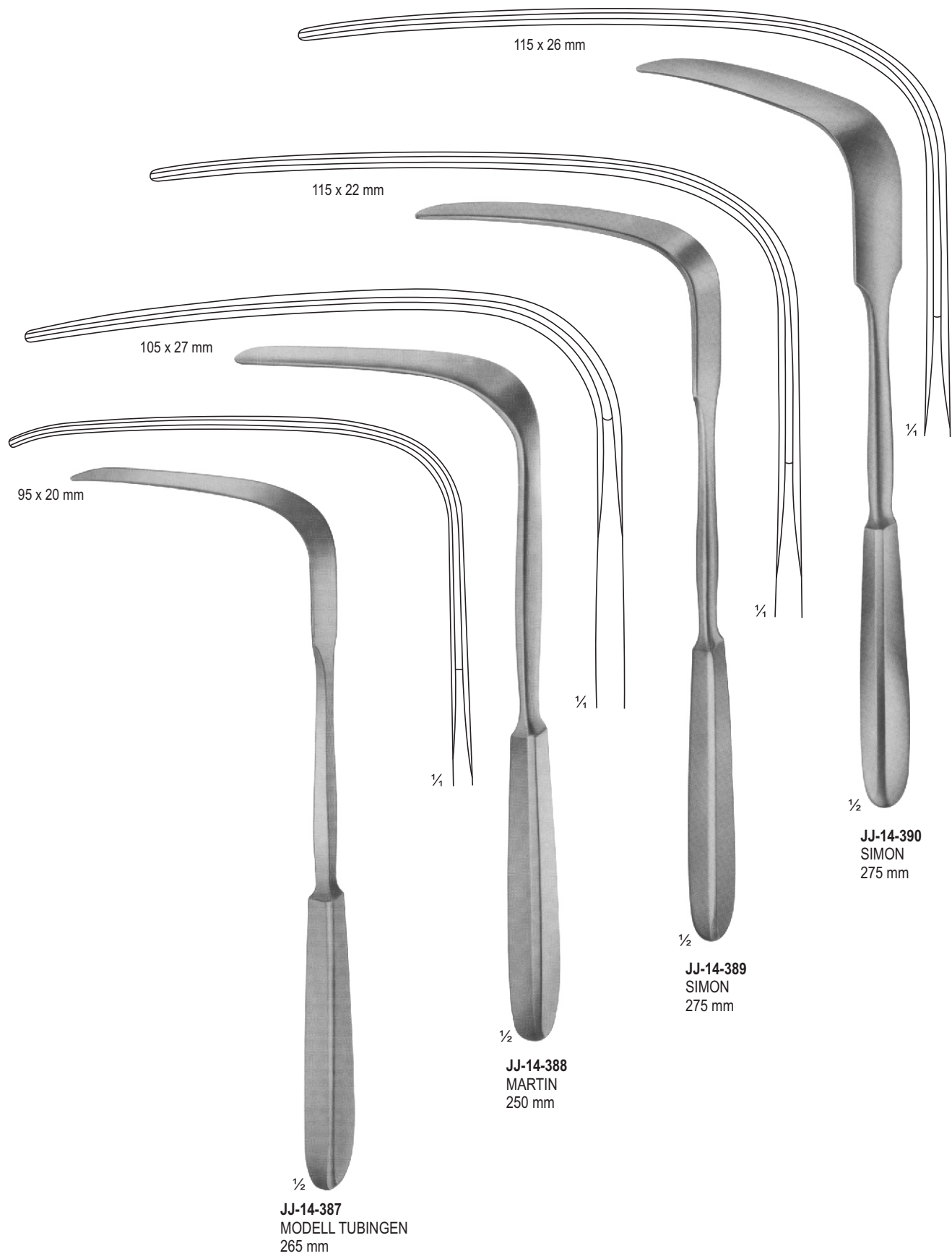

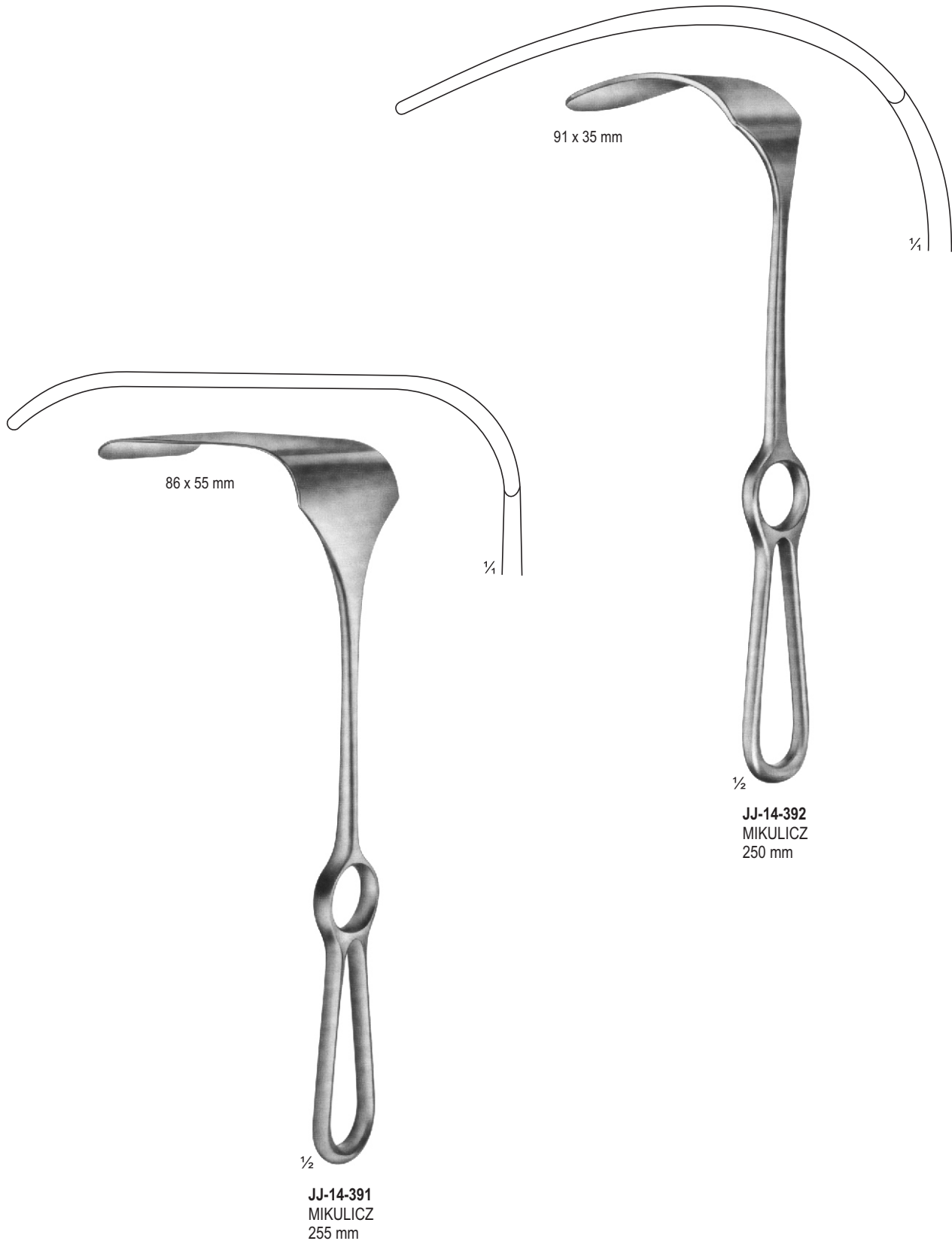

ABDOMINAL RETRACTORS

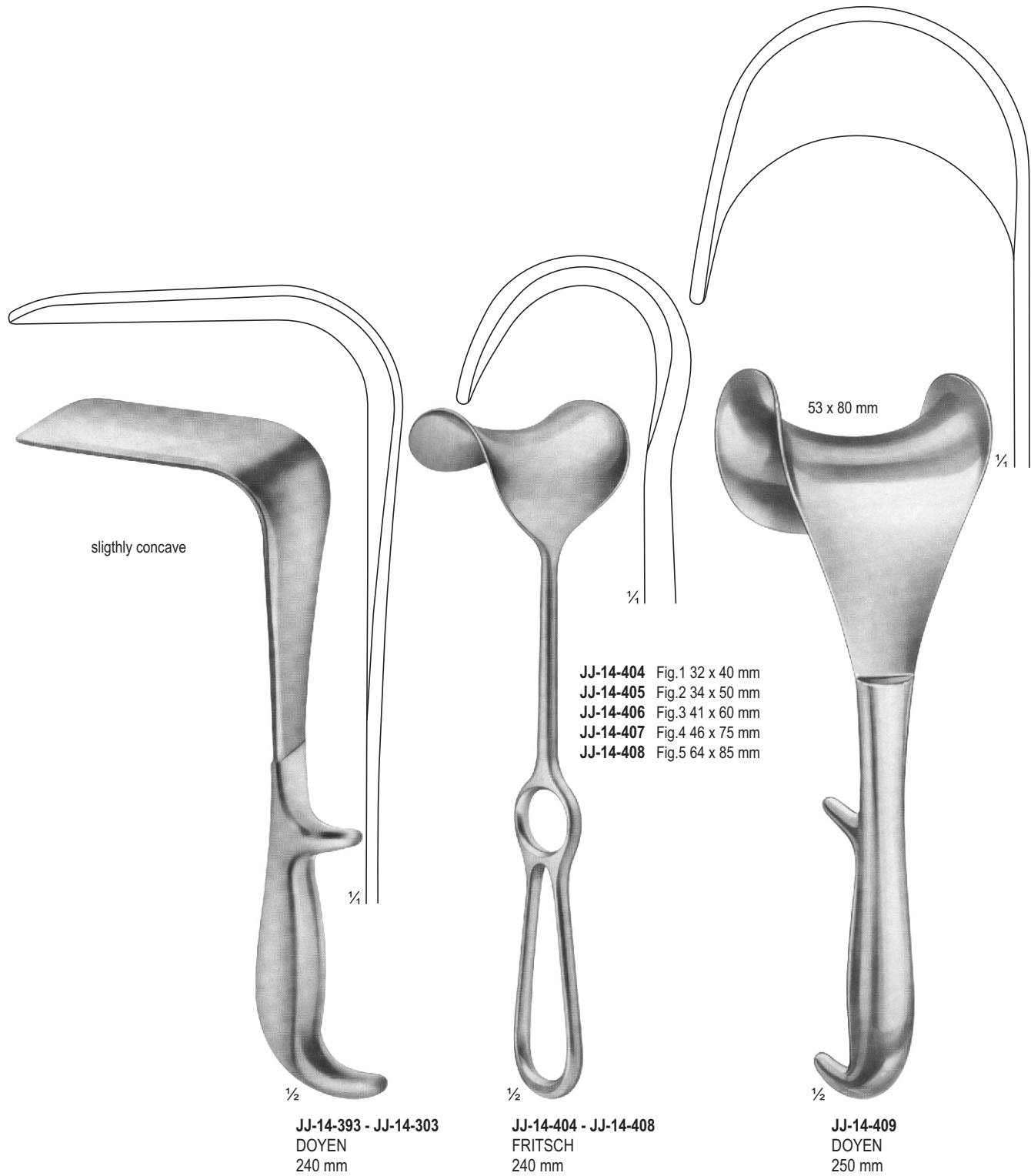

Width of Blades
35 mm, 45 mm, 60 mm

Length of Blades
62 mm
92 mm
122 mm
160 mm

JJ-14-393, JJ-14-397, JJ-14-401
JJ-14-394, JJ-14-398, JJ-14-402
JJ-14-395, JJ-14-399, JJ-14-403
JJ-14-396, JJ-14-400

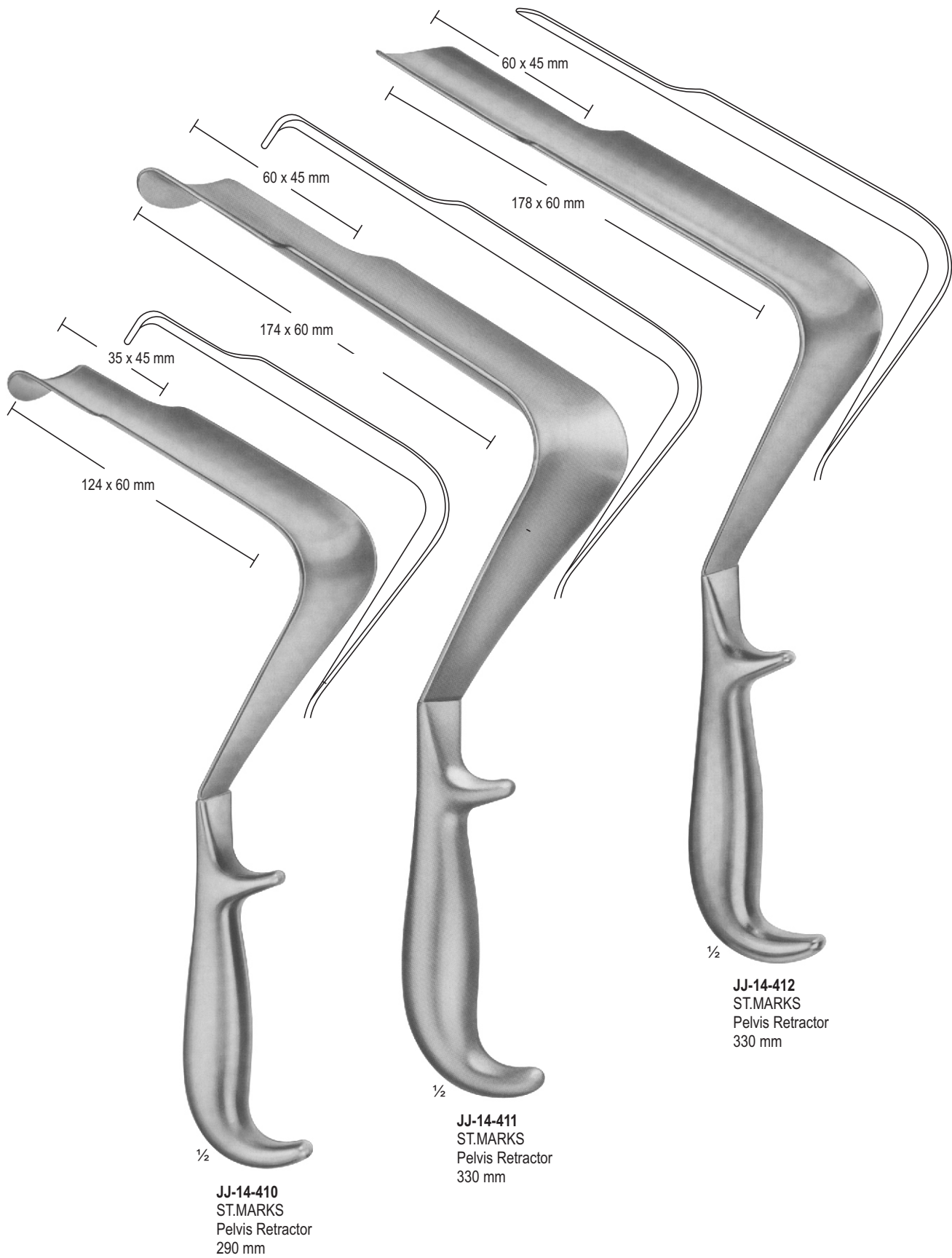

ABDOMINAL- AND INTESTINAL SPATULAS

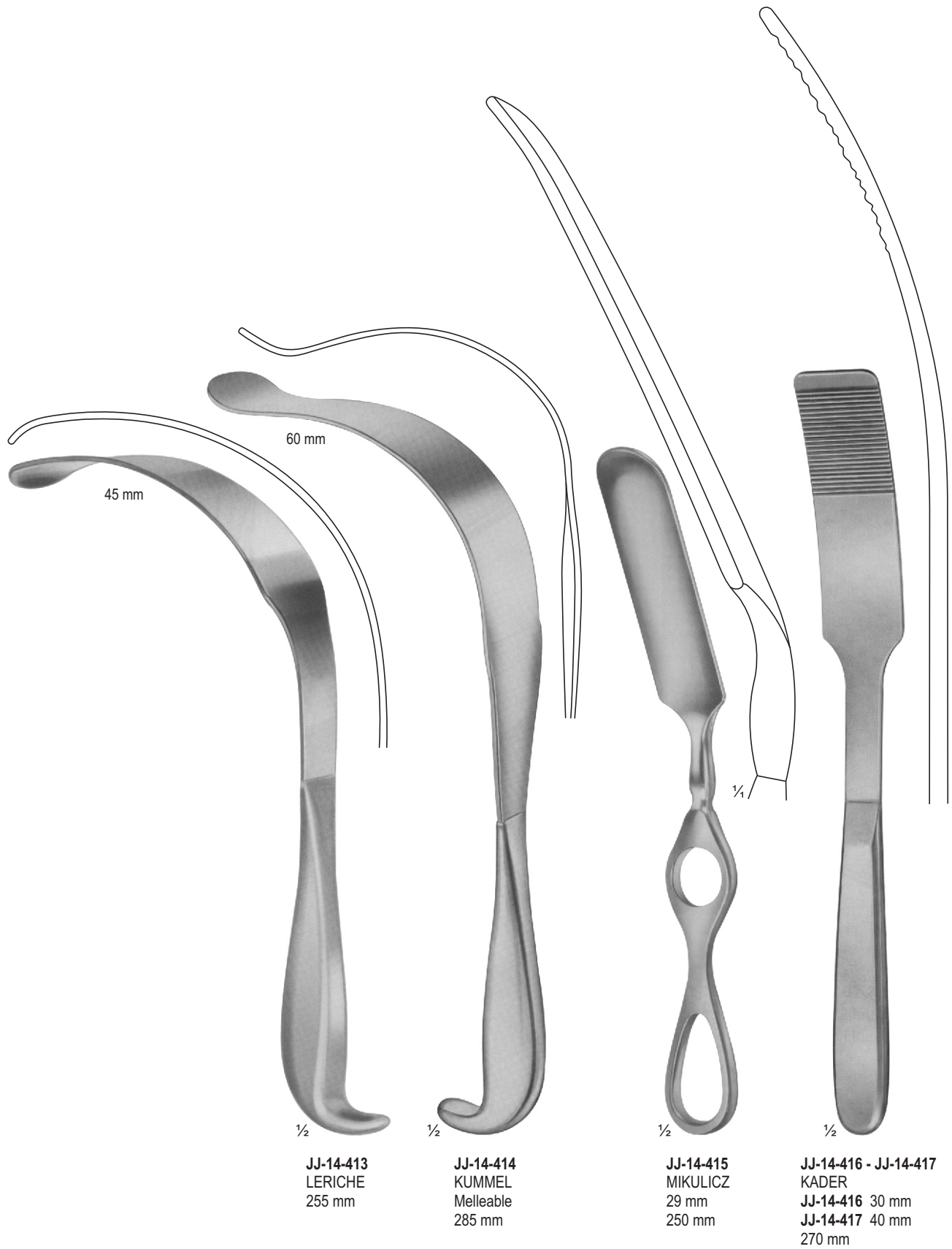

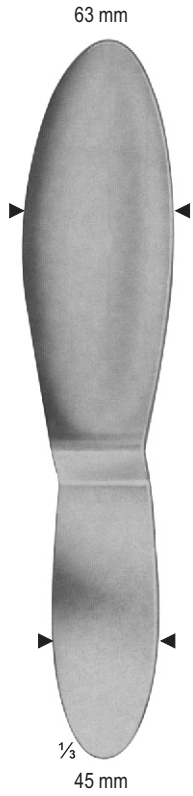

JJ-14-418
REVERDIN
285 mm



JJ-14-419
HABERER
Malleable
305 mm



JJ-14-420 - JJ-14-422
JJ-14-420 30 mm
JJ-14-421 40 mm
JJ-14-422 50 mm
Malleable
330 mm



JJ-14-423
TUFFIER
Melleable
200 mm

Page 289–311

- Dilators
- Biopsy Instruments And Curettes
- Uterine Probes, Uterine Dressing - Tenaculum
- Ovum Forceps
- Uterine Elevating Forceps

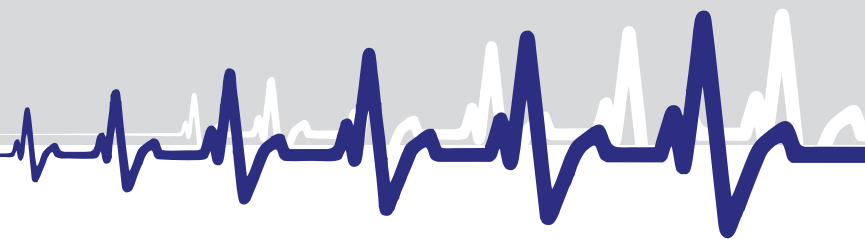



JJ-15-101 - JJ-15-143
HEGAR
with very conical point
185 mm

JJ-15-101	1	mm	JJ-15-123	23	mm
JJ-15-102	2	mm	JJ-15-124	24	mm
JJ-15-103	3	mm	JJ-15-125	25	mm
JJ-15-104	4	mm	JJ-15-126	26	mm
JJ-15-105	5	mm	JJ-15-127	1	½mm
JJ-15-106	6	mm	JJ-15-128	2	½mm
JJ-15-107	7	mm	JJ-15-129	3	½mm
JJ-15-108	8	mm	JJ-15-130	4	½mm
JJ-15-109	9	mm	JJ-15-131	5	½mm
JJ-15-110	10	mm	JJ-15-132	6	½mm
JJ-15-111	11	mm	JJ-15-133	7	½mm
JJ-15-112	12	mm	JJ-15-134	8	½mm
JJ-15-113	13	mm	JJ-15-135	9	½mm
JJ-15-114	14	mm	JJ-15-136	10	½mm
JJ-15-115	15	mm	JJ-15-137	11	½mm
JJ-15-116	16	mm	JJ-15-138	12	½mm
JJ-15-117	17	mm	JJ-15-139	13	½mm
JJ-15-118	18	mm	JJ-15-140	14	½mm
JJ-15-119	19	mm	JJ-15-141	15	½mm
JJ-15-120	20	mm	JJ-15-142	16	½mm
JJ-15-121	21	mm	JJ-15-143	17	½mm
JJ-15-122	22	mm			



JJ-15-144 - JJ-15-152
HEGAR
205 mm

JJ-15-144	1+2	mm
JJ-15-145	3+4	mm
JJ-15-146	5+6	mm
JJ-15-147	7+8	mm
JJ-15-148	9+10	mm
JJ-15-149	11+12	mm
JJ-15-150	13+14	mm
JJ-15-151	15+16	mm
JJ-15-152	17+18	mm

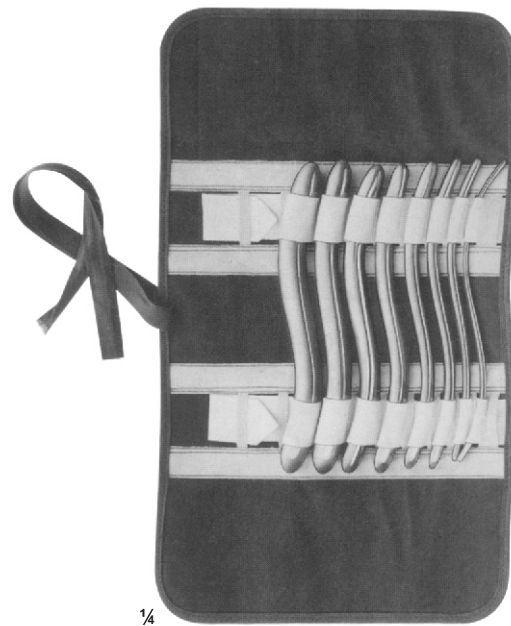

JJ-15-153
HEGAR
Uterine dilator set, in canvas
roll with 8 dilators.

UTERINE DILATORS - COMPLETE SETS



JJ-15-154
HEGAR
Dilator set consisting of:
14 Dilators,
1 Rack for dilators (4 - 12 mm)
1 Rack for Dilators (13 - 17 mm)
1 Metal case only,
with hinged lid, stainless 200 X 100 X 35 mm

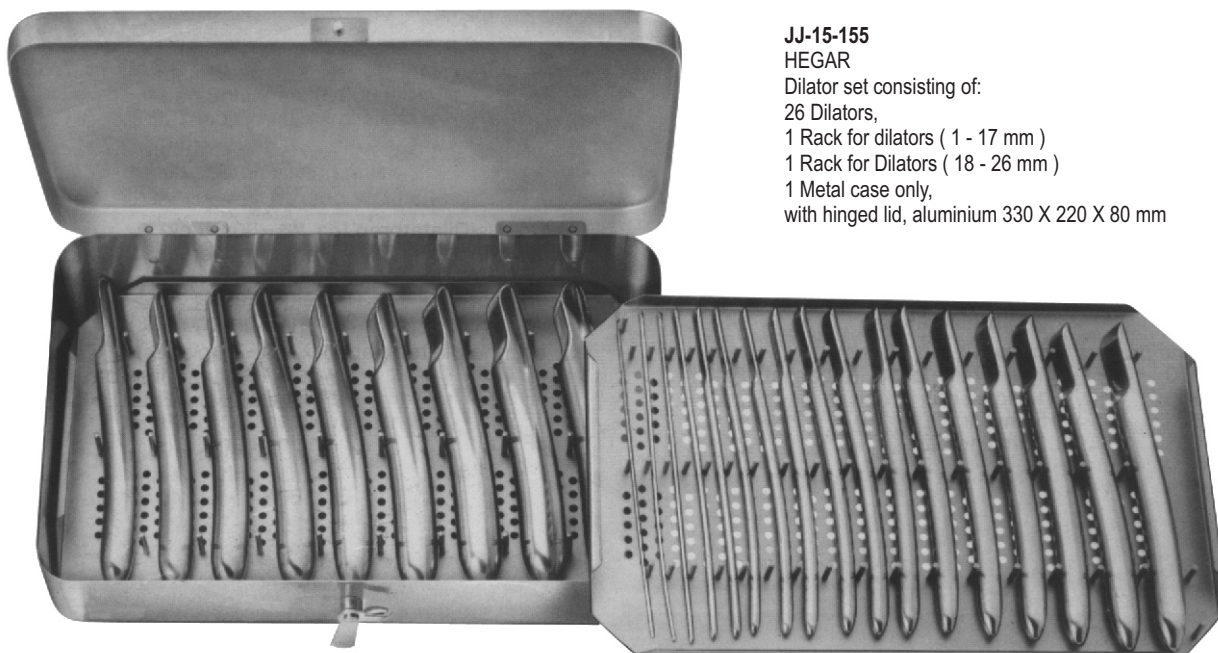

JJ-15-155
HEGAR
Dilator set consisting of:
26 Dilators,
1 Rack for dilators (1 - 17 mm)
1 Rack for Dilators (18 - 26 mm)
1 Metal case only,
with hinged lid, aluminium 330 X 220 X 80 mm

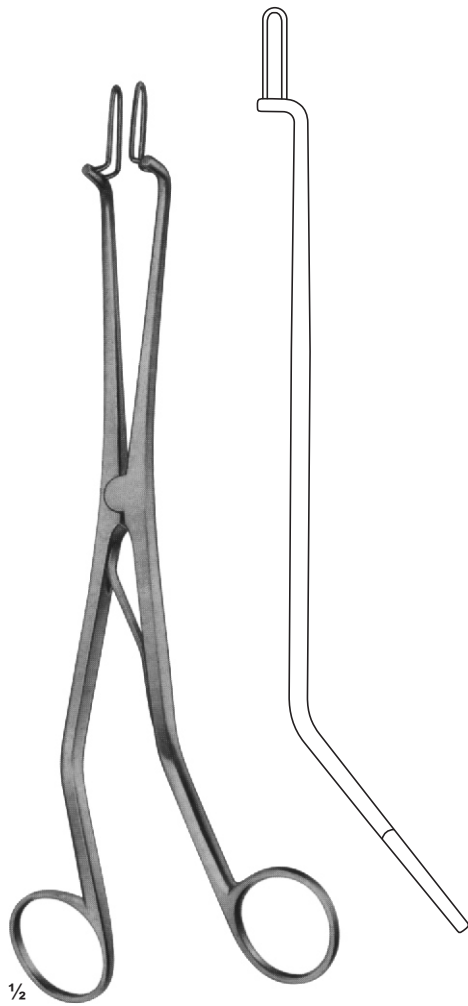

JJ-15-156
KOGAN
Endospecula for cervix
and urethra, without ratchet
240 mm

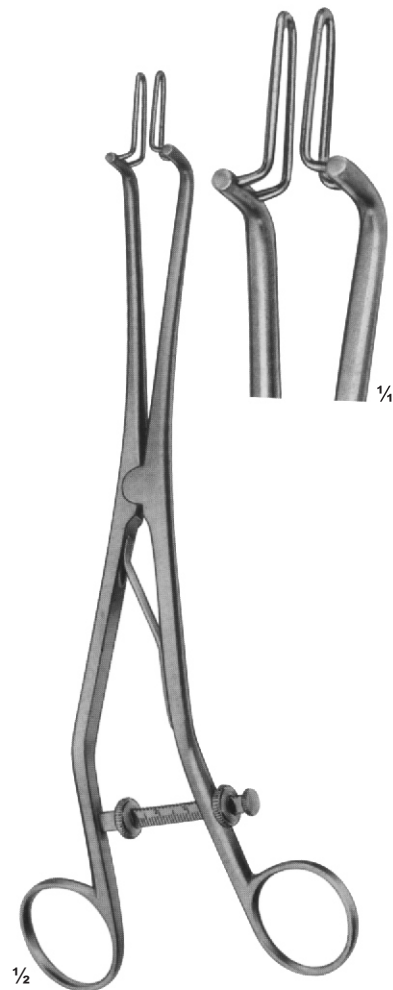

JJ-15-157
KOGAN
Endospecula for cervix
and urethra, with
scale-ratchet and fixing screws
240 mm

UTERINE PROBES, COTTON AND CAUSTIC HOLDER

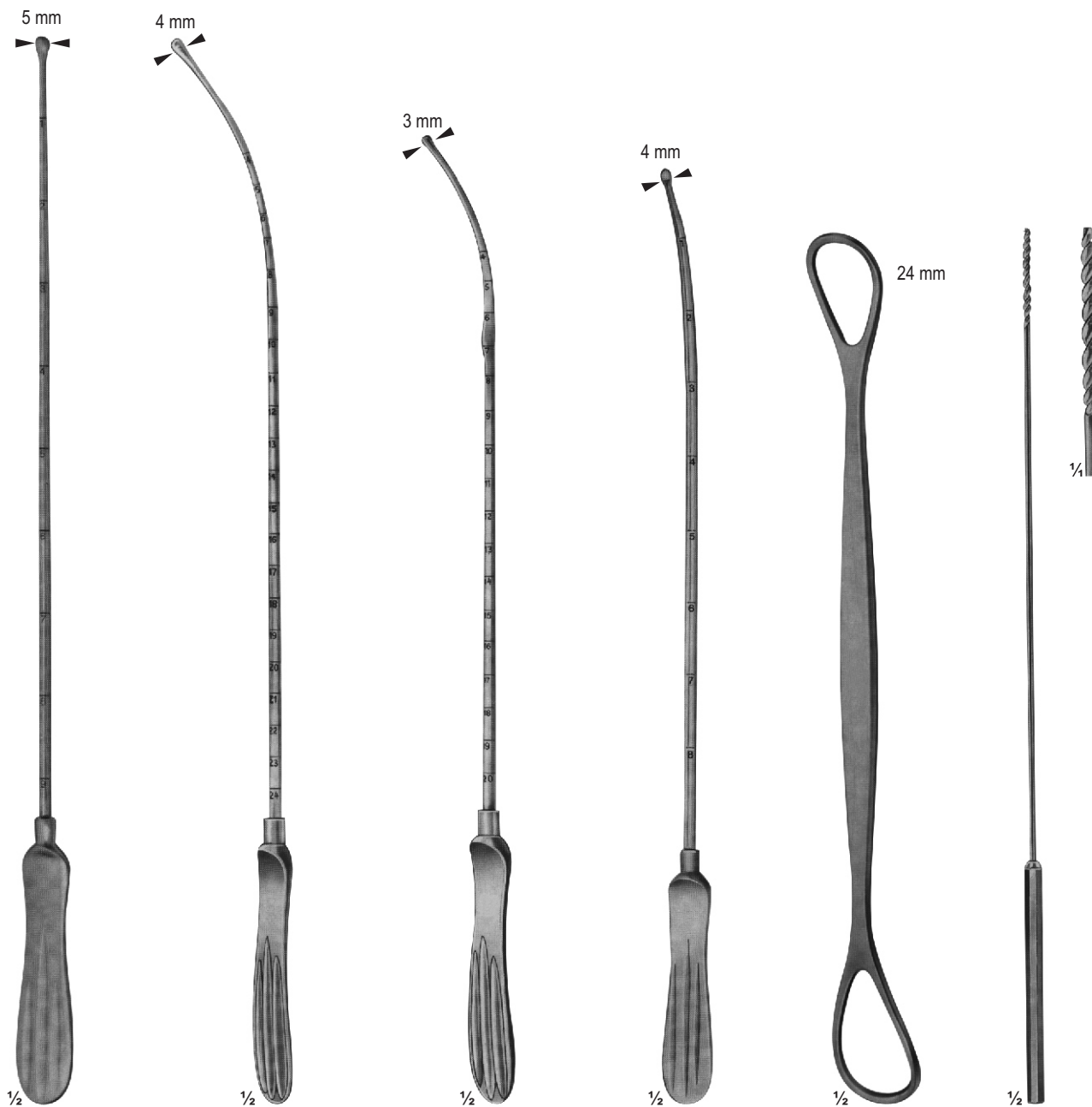

JJ-15-158
MAYO
biegsam malleable
330 mm

JJ-15-159
SIMS
biegsam malleable
330 mm

JJ-15-160
MARTIN
330 mm

JJ-15-161
SIMPSON
malleable
silver-plated
290 mm

JJ-15-162
BRAUN
Uterine
depressor
270 mm

JJ-15-163
Cotton
applicator
270 mm

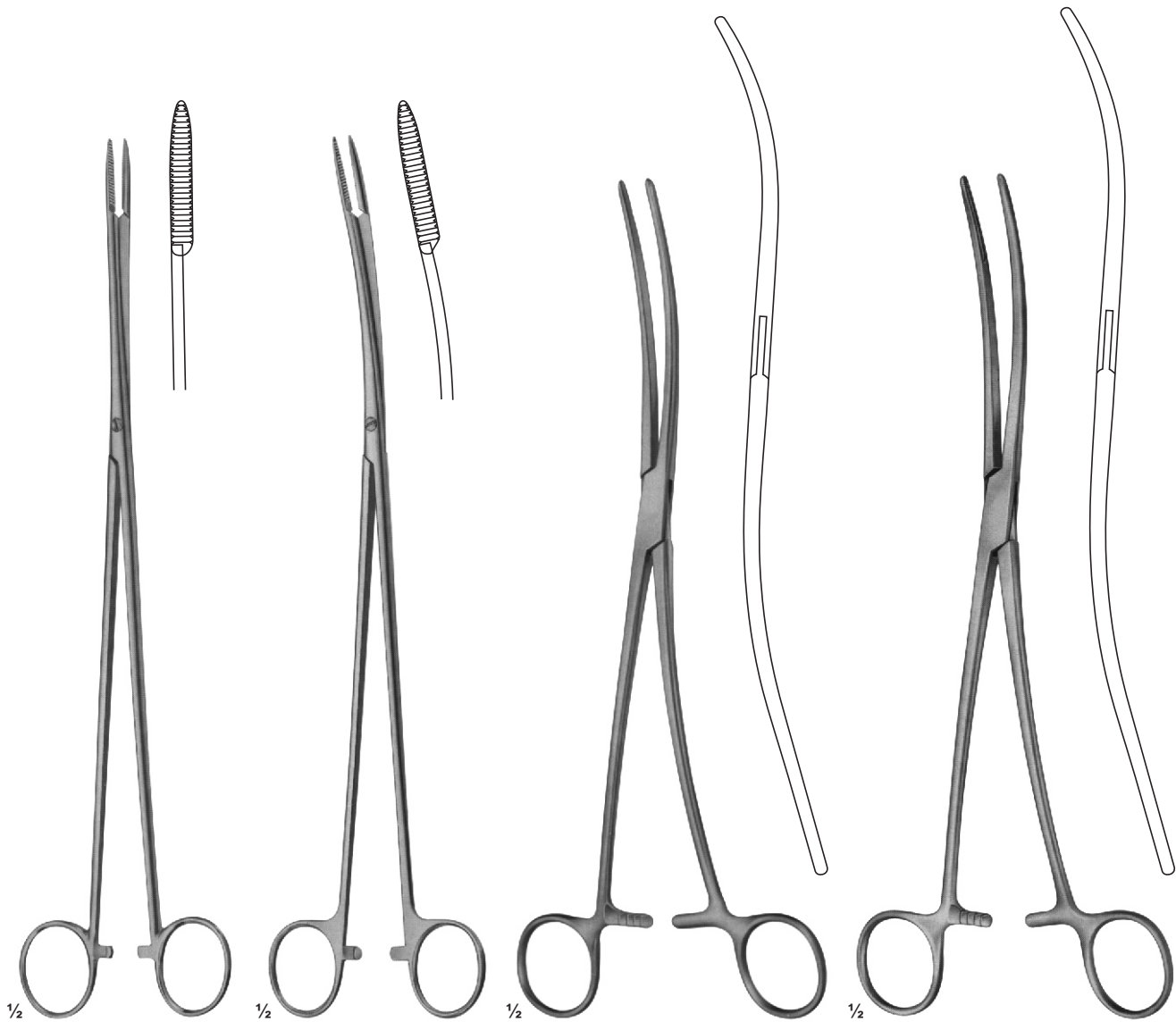

JJ-15-164
PELKMANN
260 mm

JJ-15-165
PELKMANN
260 mm

JJ-15-166
BOZEMANN
250 mm

JJ-15-167
BOZEMANN
255 mm

Jaws with longitudinal groove

UTERINE DRESSING FORCEPS

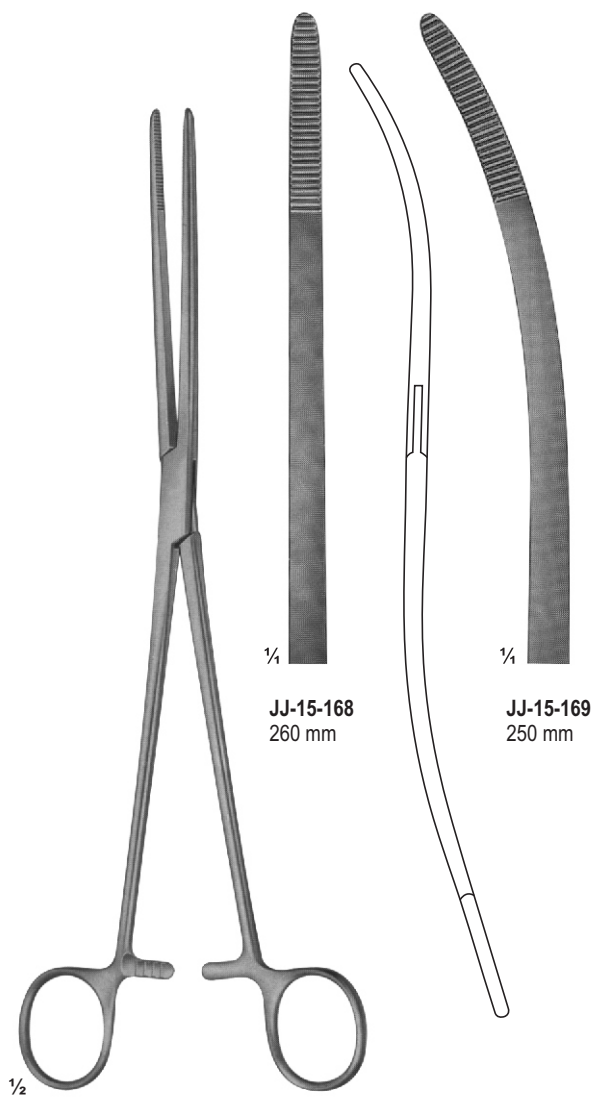

JJ-15-168
260 mm

JJ-15-169
250 mm

JJ-15-168 - JJ-15-169
BOZEMANN

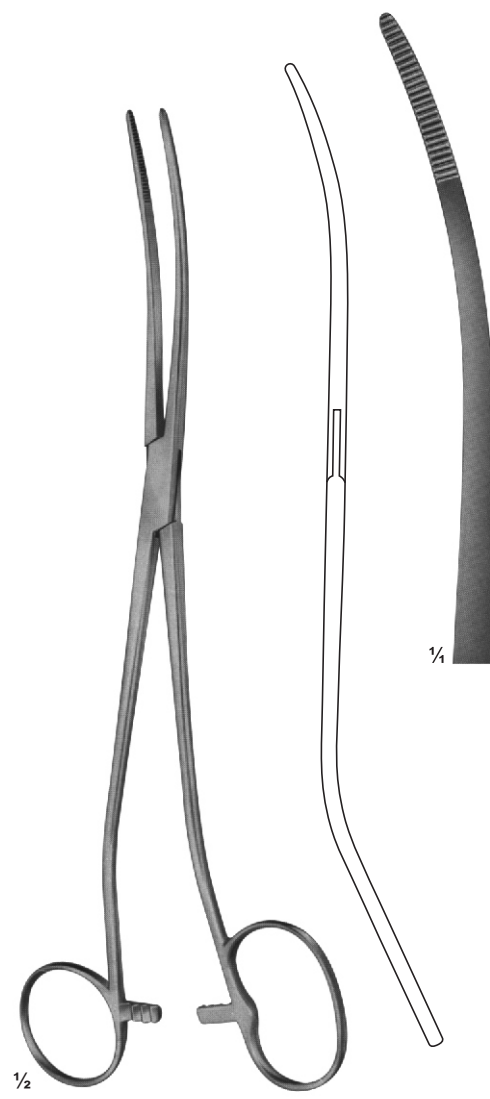

JJ-15-170
BOZEMANN-DOUGLAS
260 mm



JJ-15-171
BRAUN
slender type
250 mm

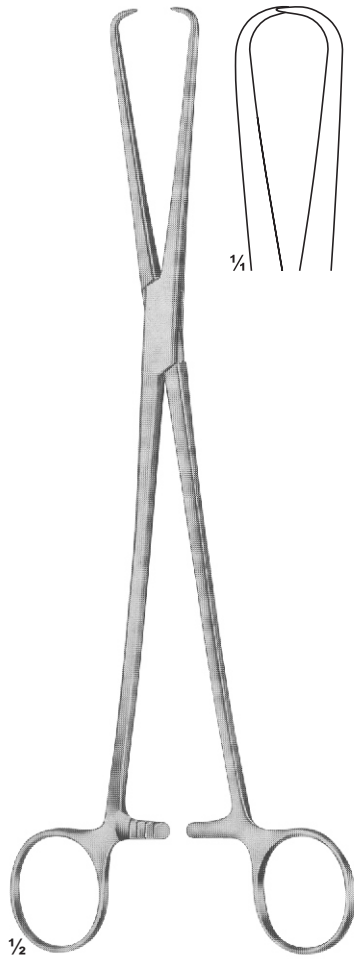

JJ-15-172
SCHRODER
250 mm



JJ-15-173
POZZI
heavy type
255 mm

UTERINE TENACULUM FORCEPS

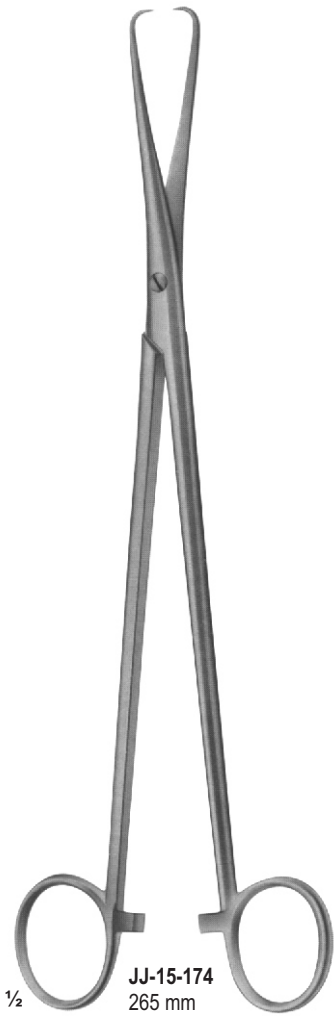

JJ-15-174
265 mm

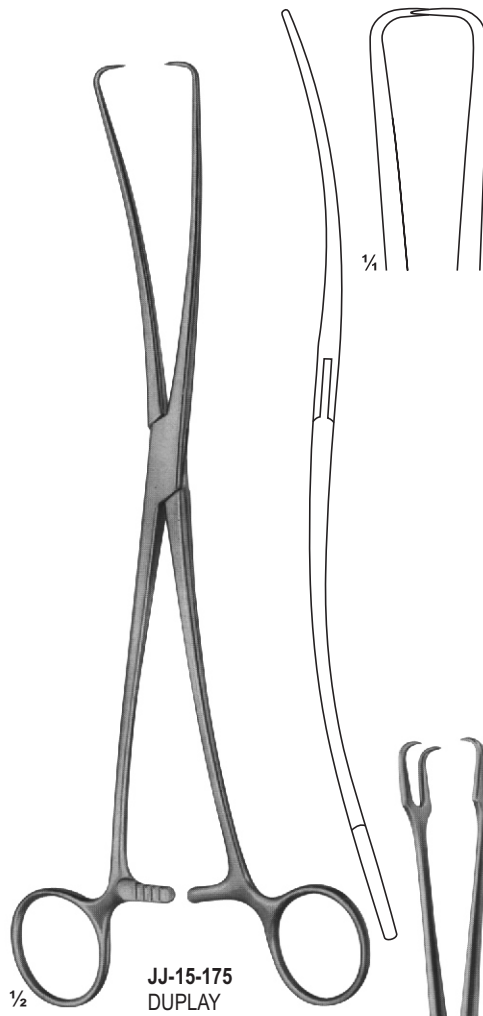

JJ-15-175
DUPLAY
250 mm

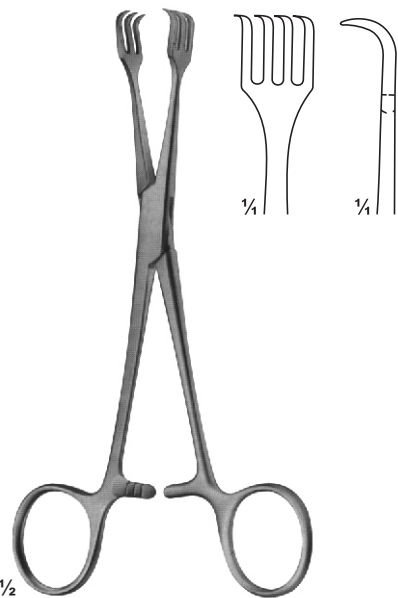
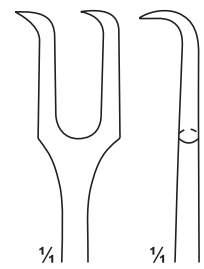

JJ-15-176
LAHEY
155 mm

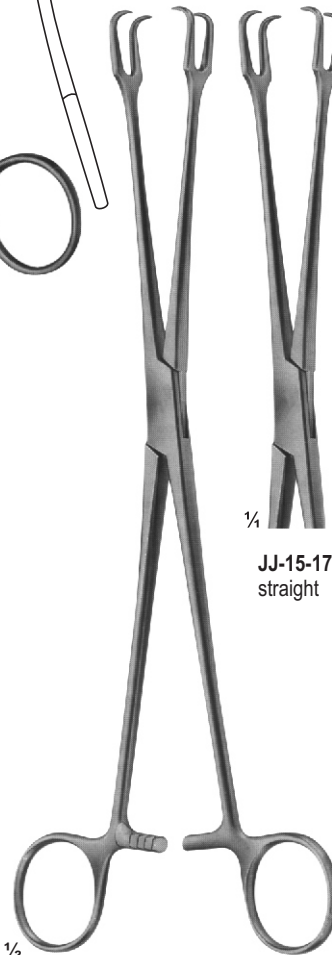

JJ-15-177 - JJ-15-179
SCHRODER
250 mm



JJ-15-177
straight



JJ-15-178
curved
on flat



JJ-15-179
curved
sideways

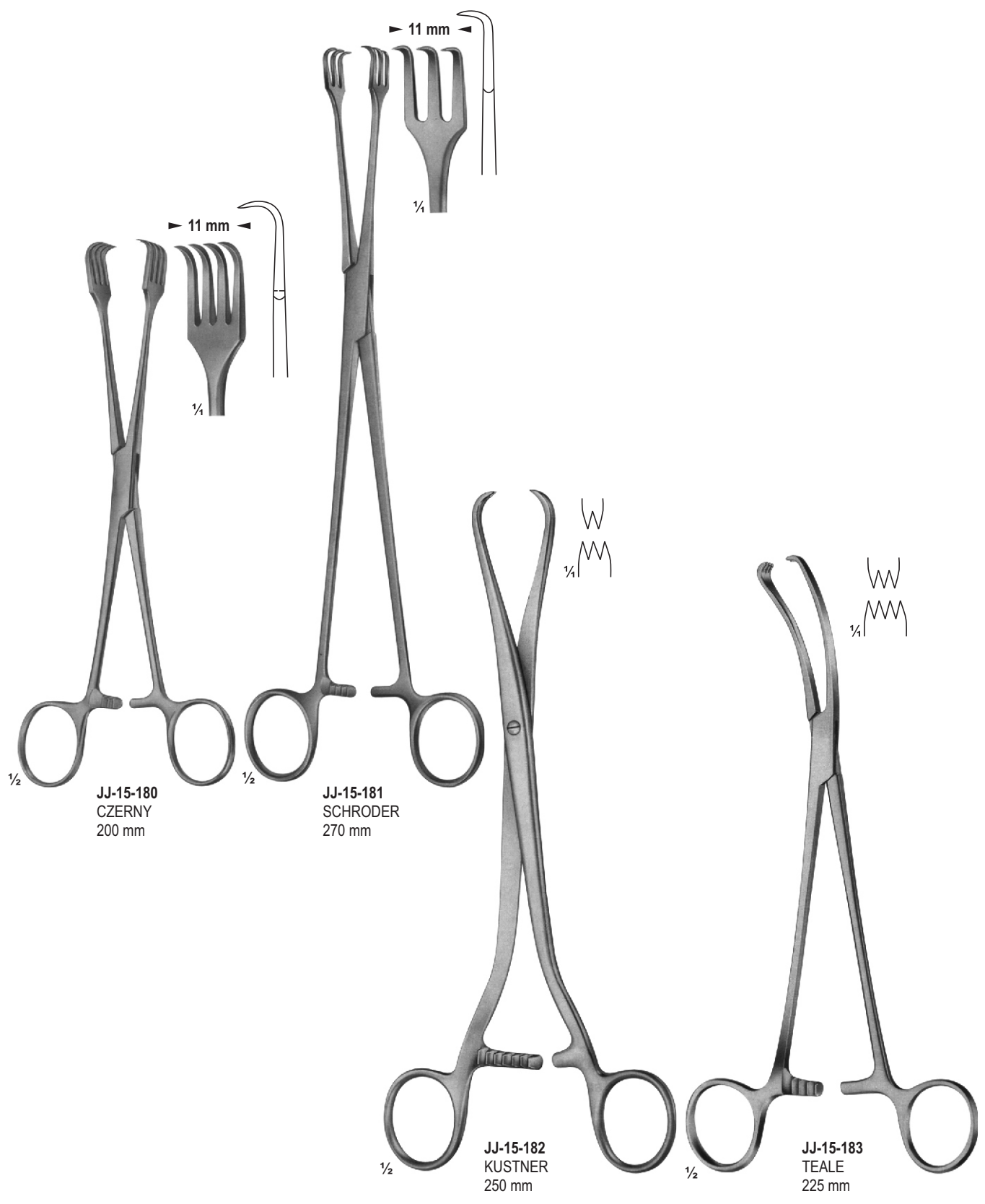

UTERINE ELEVATING FORCEPS

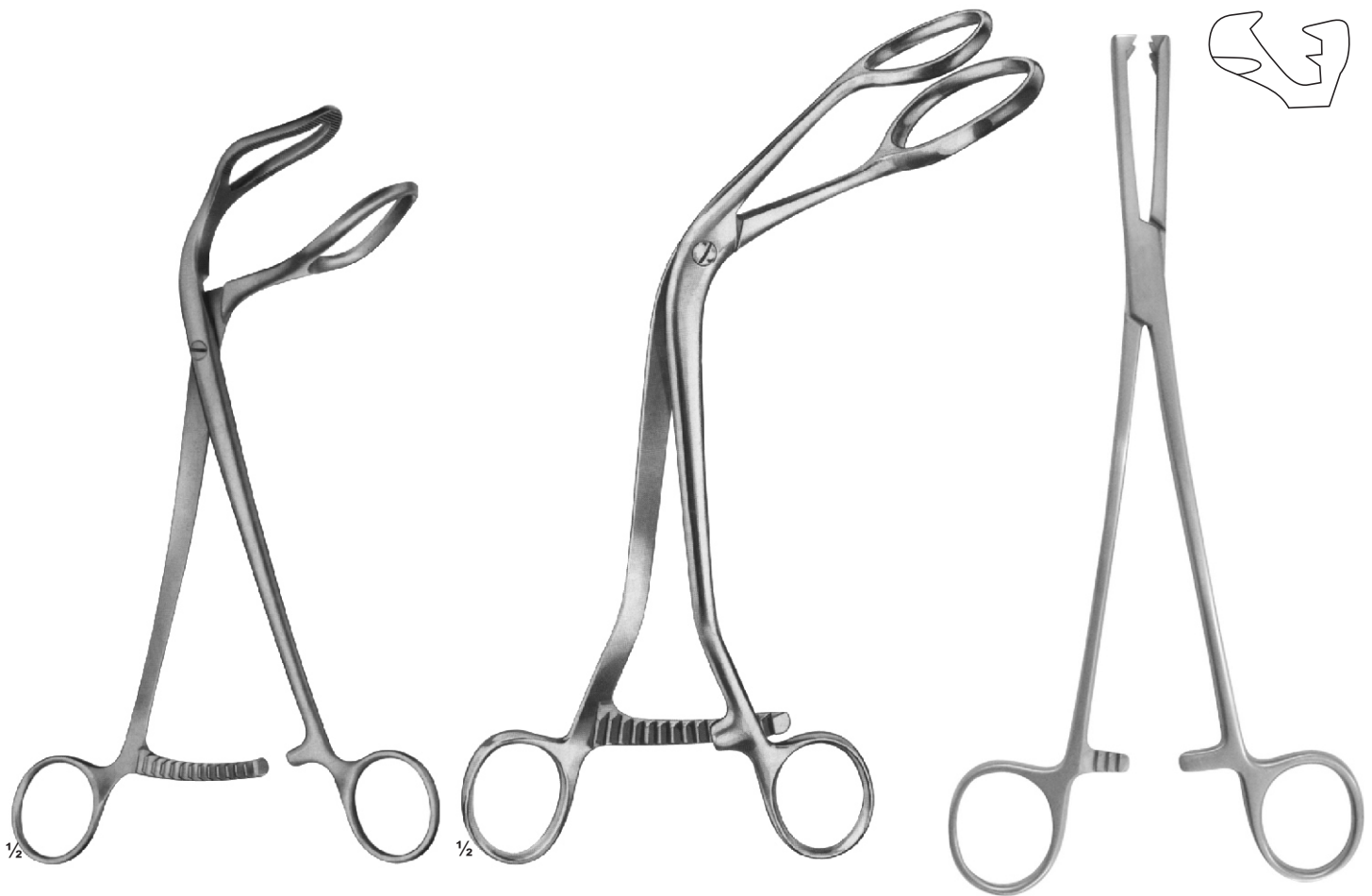

JJ-15-184
SOMER
235 mm

JJ-15-185
STRASSMANN
260 mm

JJ-15-186
JACOBS
8.5 mm

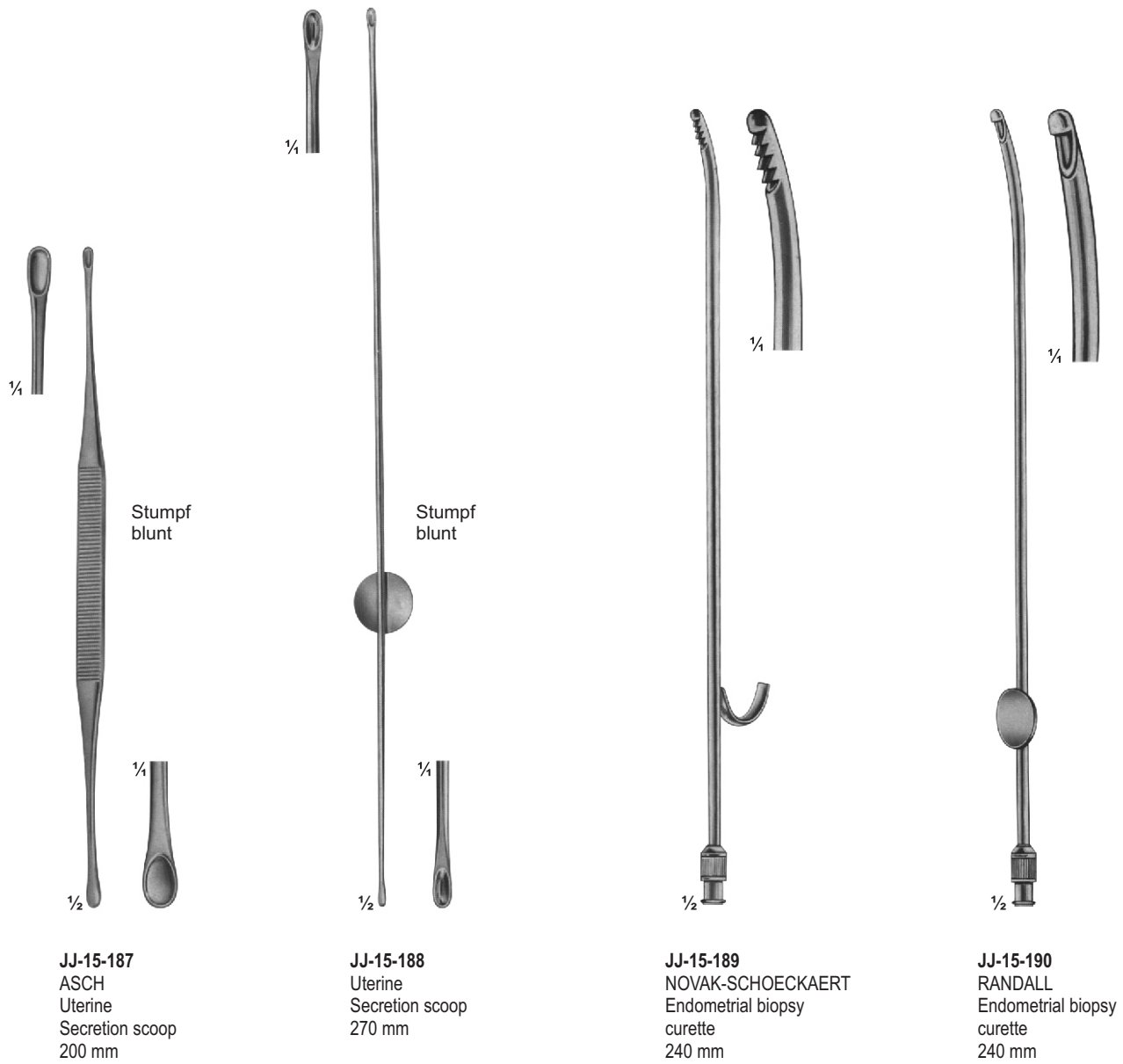

BIOPSY FORCEPS

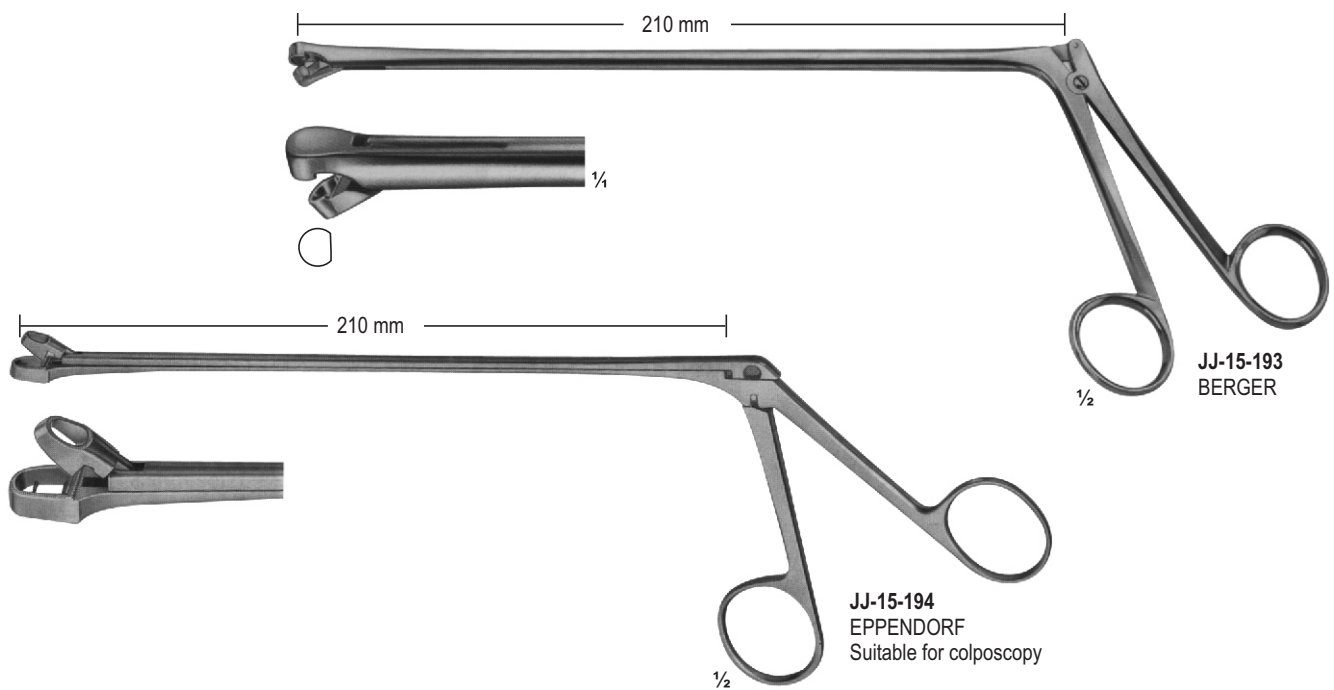
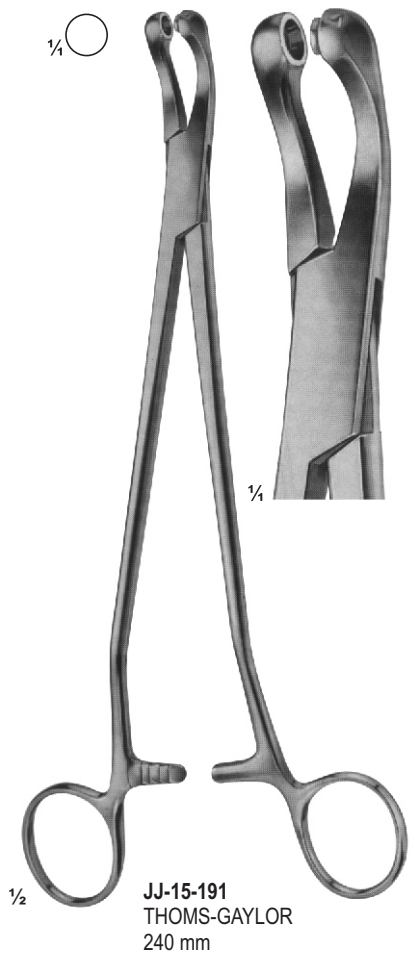

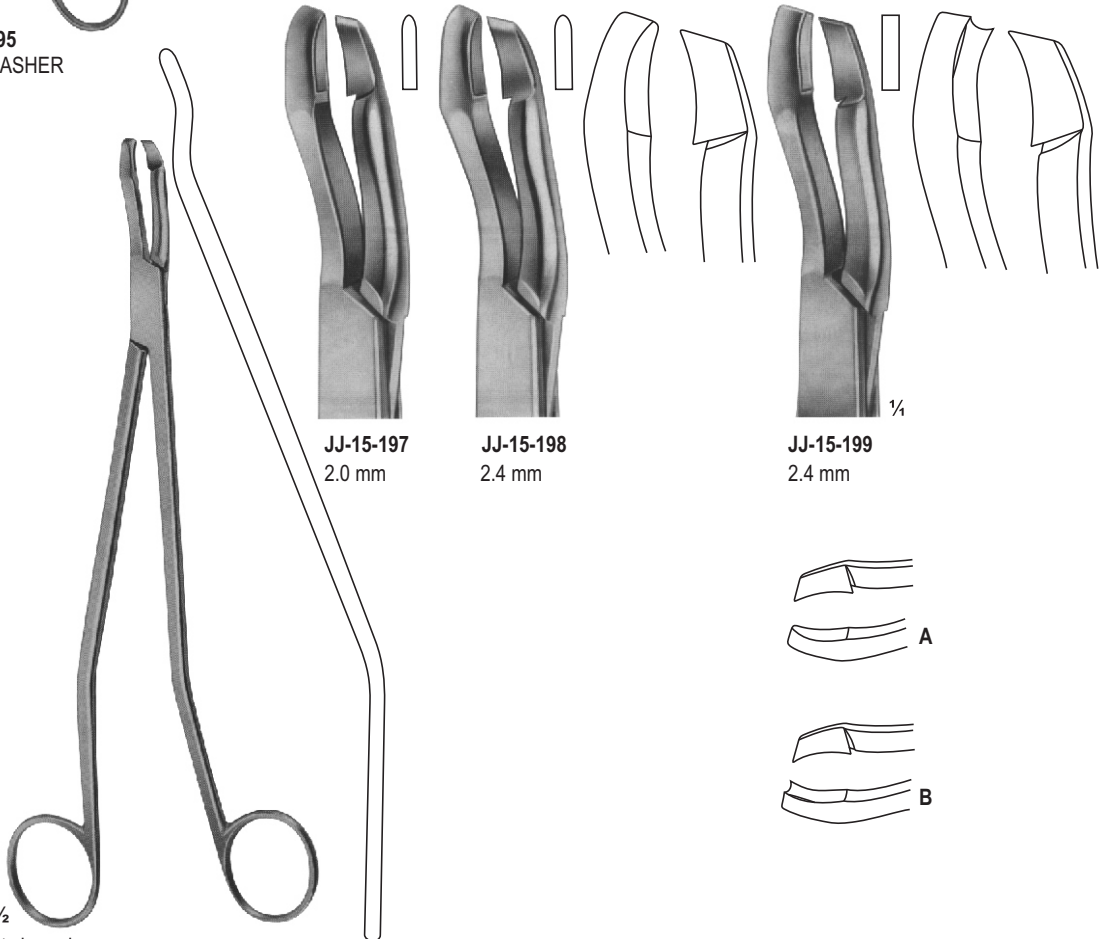
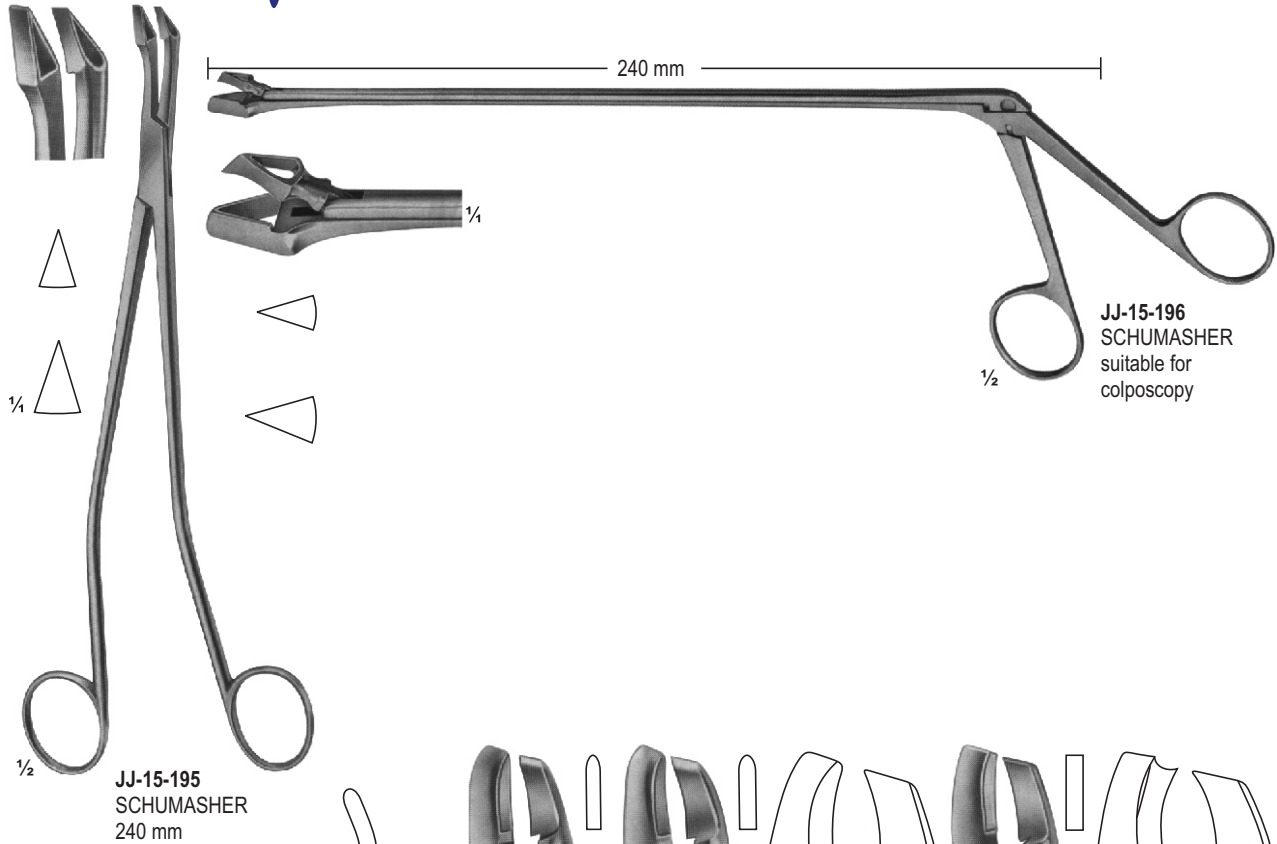

JJ-15-197 - JJ-15-199
SEIDL DBP 1/2
Biopsy forceps, bayonet shaped
for portio, vagina and vulva
240 mm

BIOPSY FORCEPS

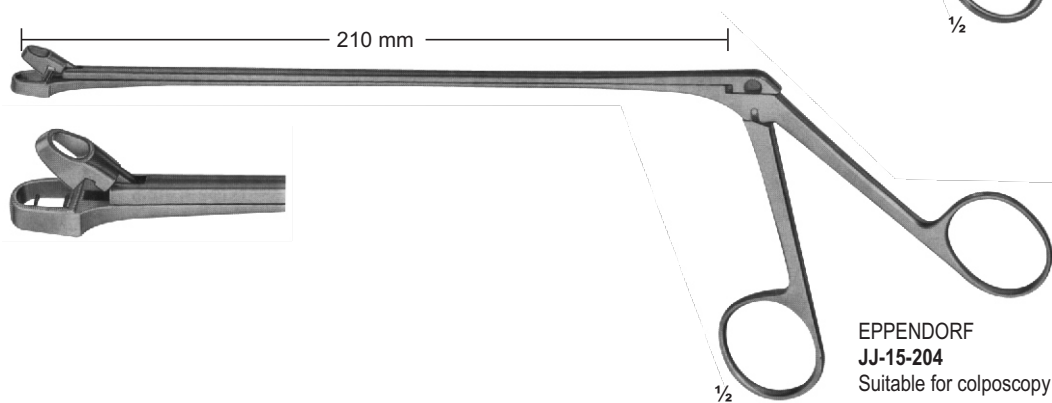
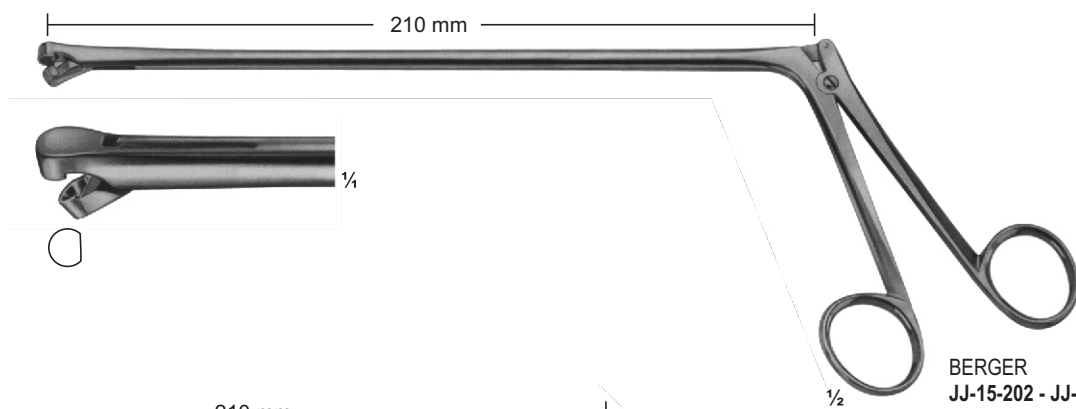
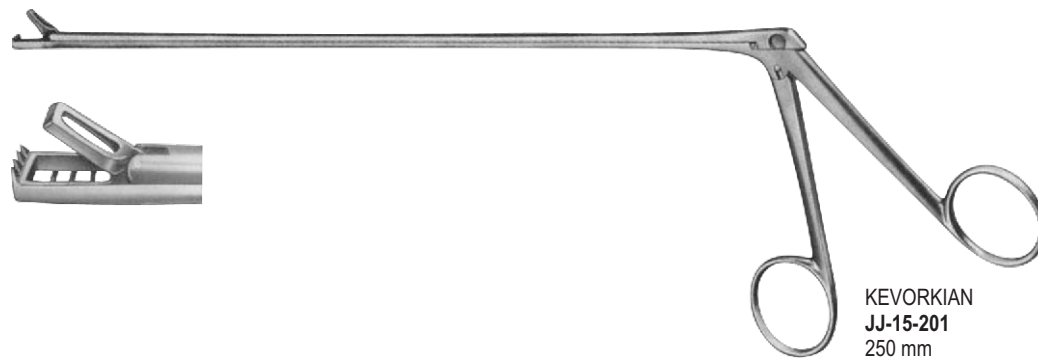
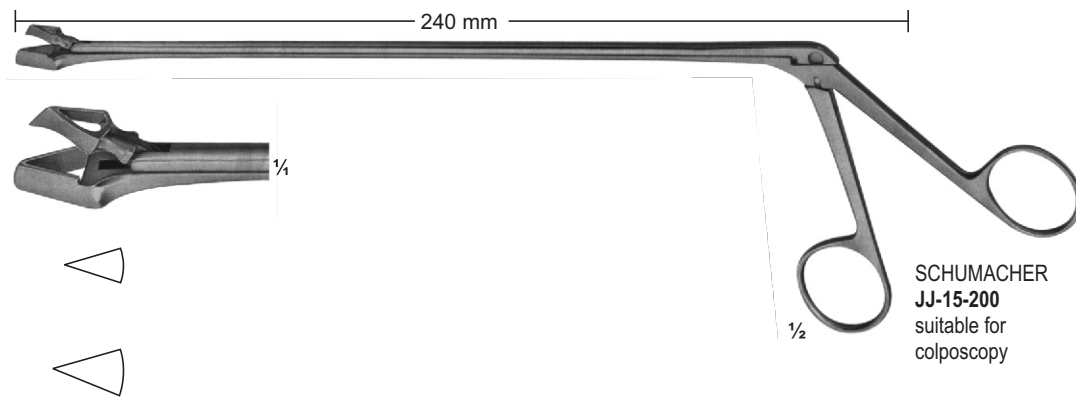

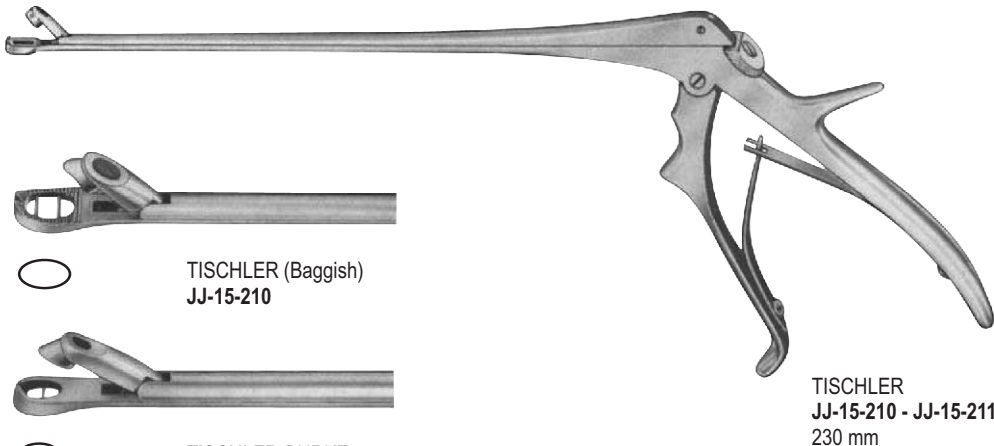
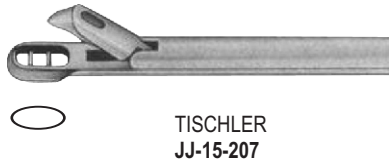
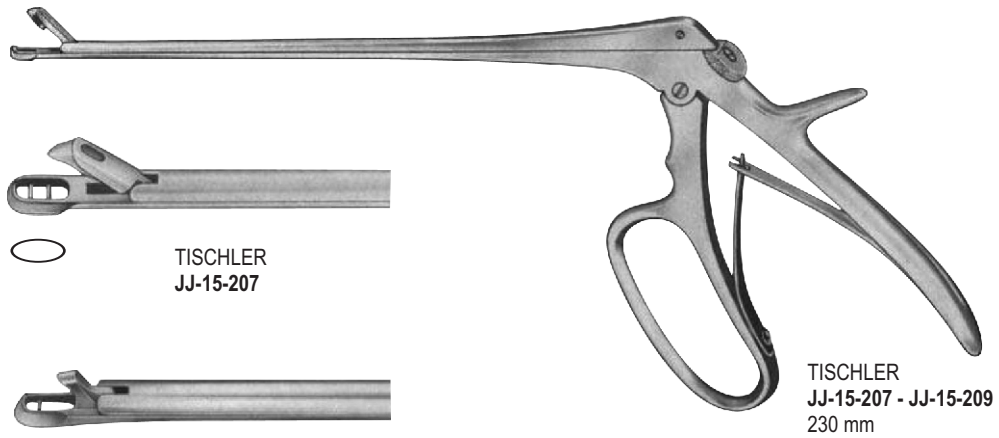

BIOPSY FORCEPS

240 mm



1/2

SCHUMACHER
NO-112
suitable for
colposcopy

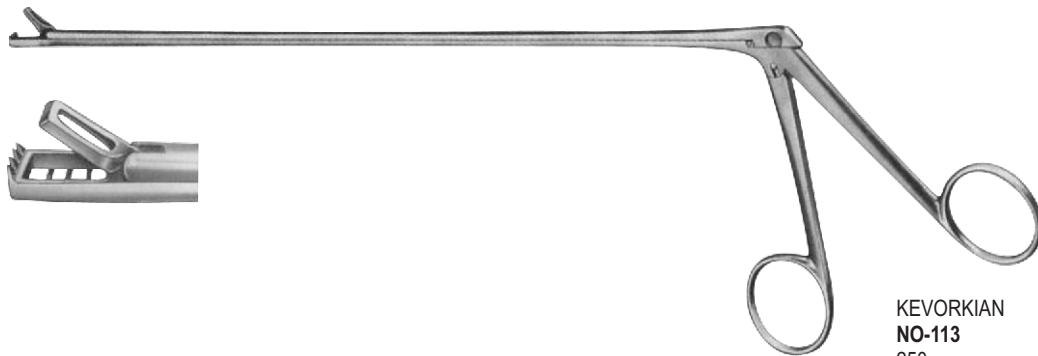

KEVORKIAN
NO-113
250 mm

210 mm



1/4

1/2

BERGER
NO-114 - NO-115
NO-114
19 cm / 3 mm
NO-115
19 cm / 5 mm

210 mm

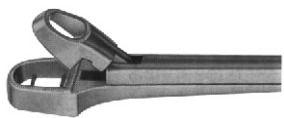

EPPENDORF
NO-116
Suitable for colposcopy

1/2

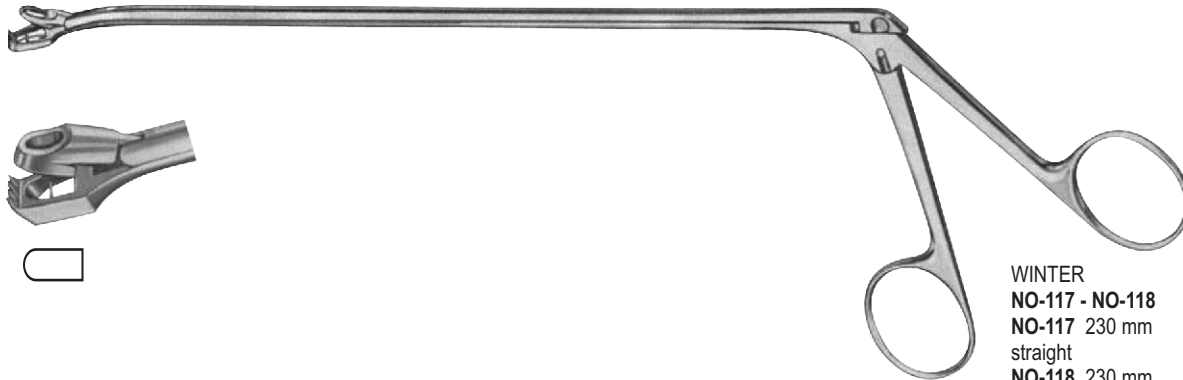

WINTER
NO-117 - NO-118
NO-117 230 mm
straight
NO-118 230 mm
curved

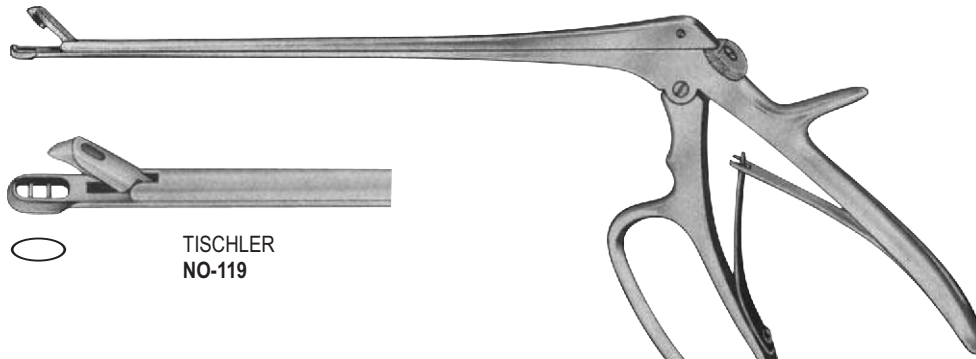

TISCHLER
NO-119 - NO-121
230 mm



TISCHLER
NO-119



TISCHLER-MINI
NO-120



KEVORKIAN-PACIFIC
NO-121

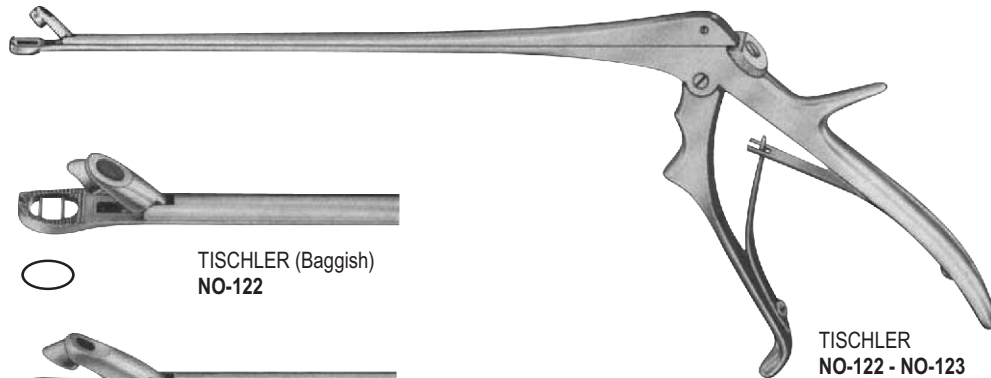

TISCHLER
NO-122 - NO-123
230 mm



TISCHLER (Baggish)
NO-122



TISCHLER-BURKE
NO-123

BIOPSY FORCEPS

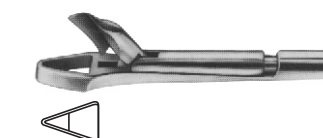
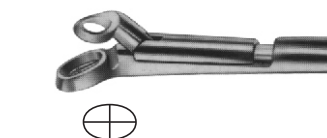
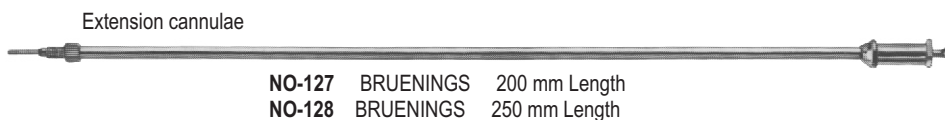
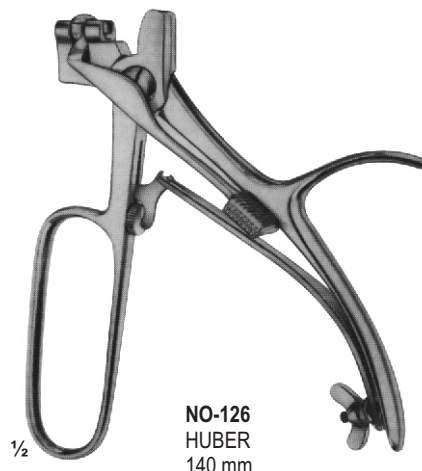
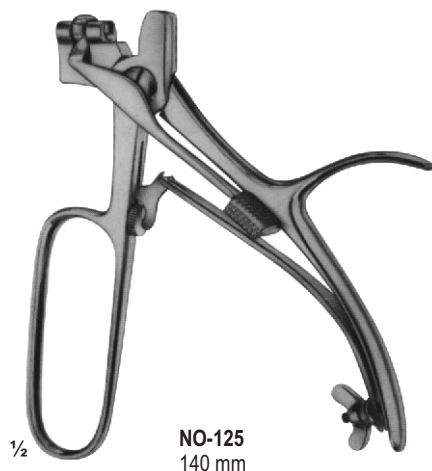
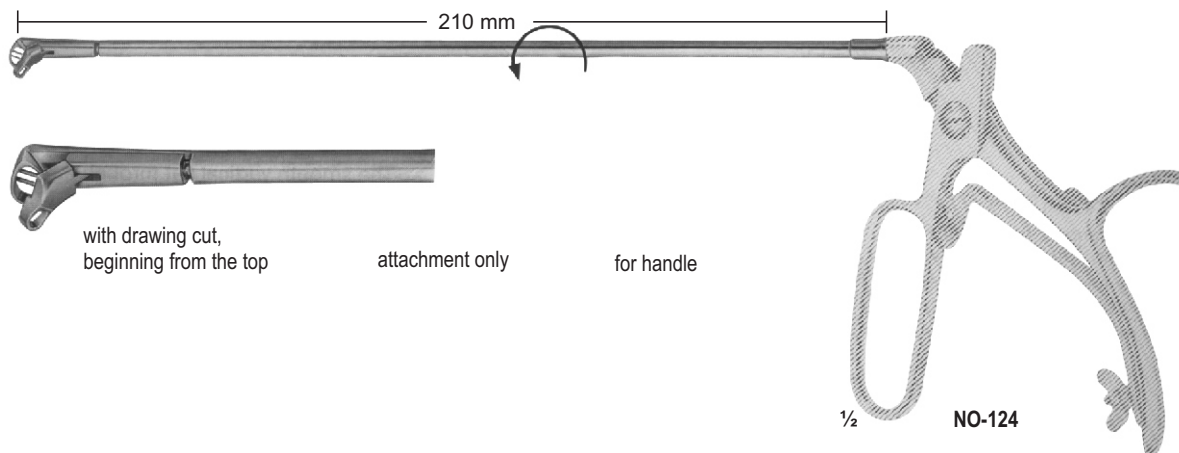

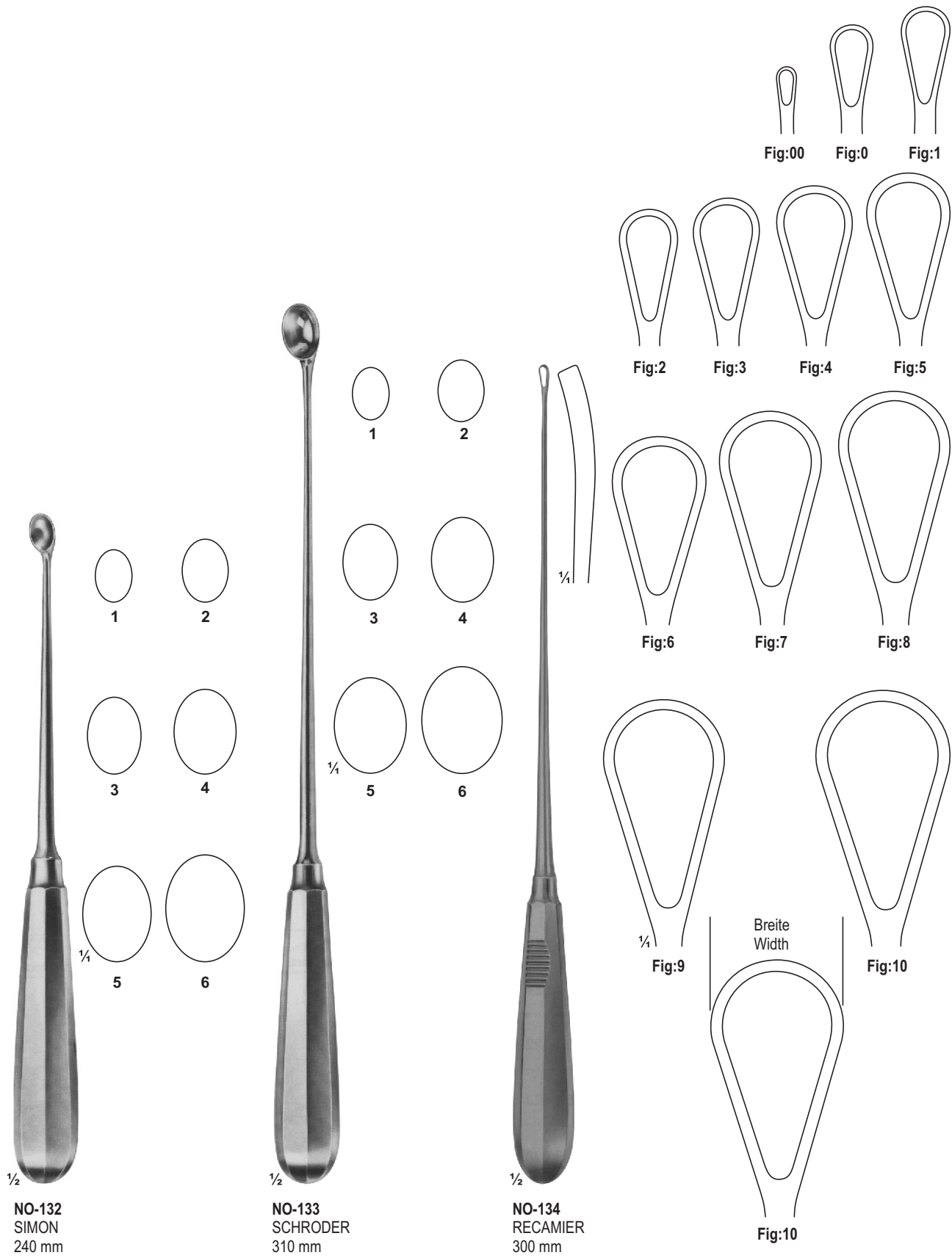

UTERINE CURETTES

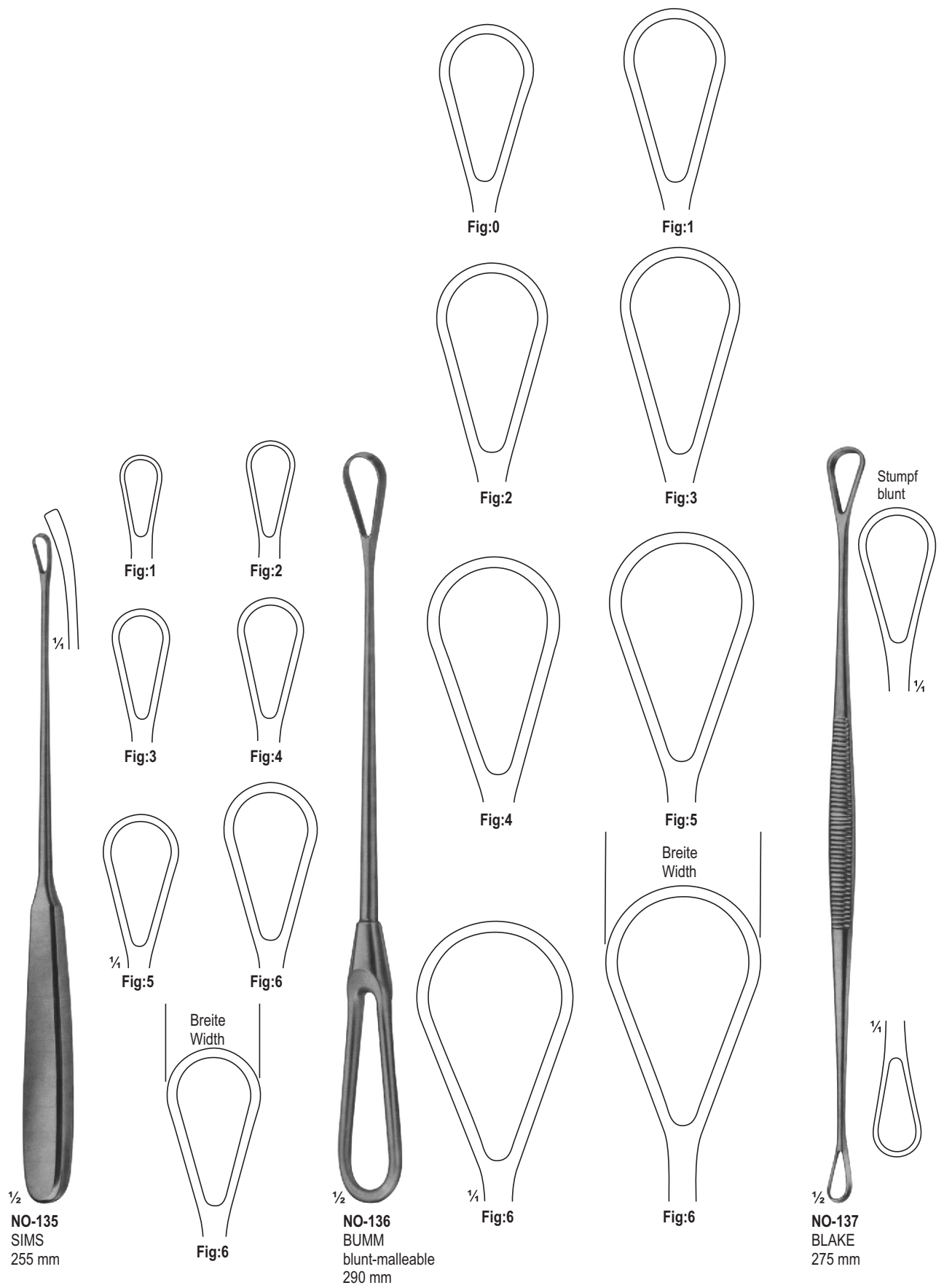



NO-138
COLLIN
300 mm

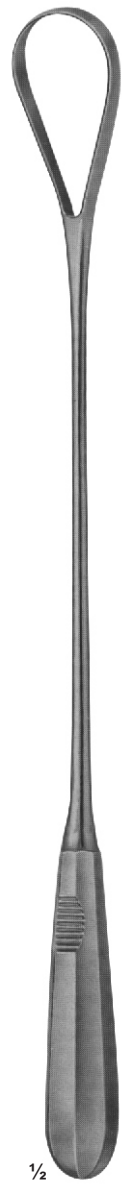

NO-139
RECAMIER
blunt-rigid
360 mm

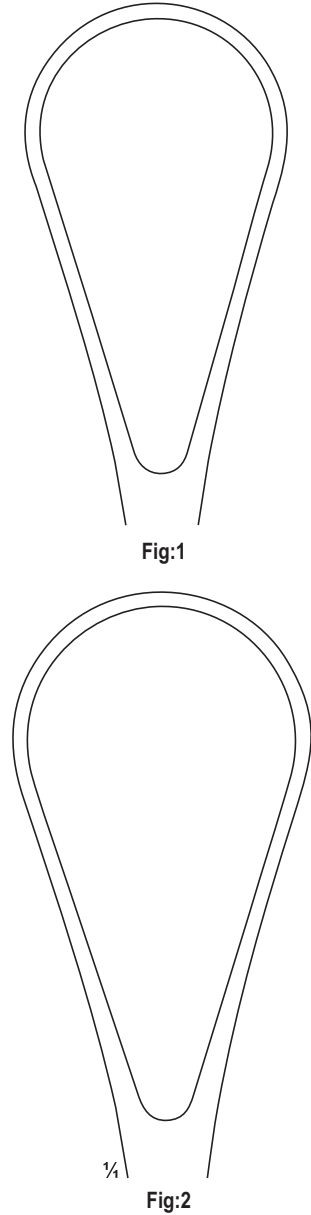

NO-140
BUMM
310 mm

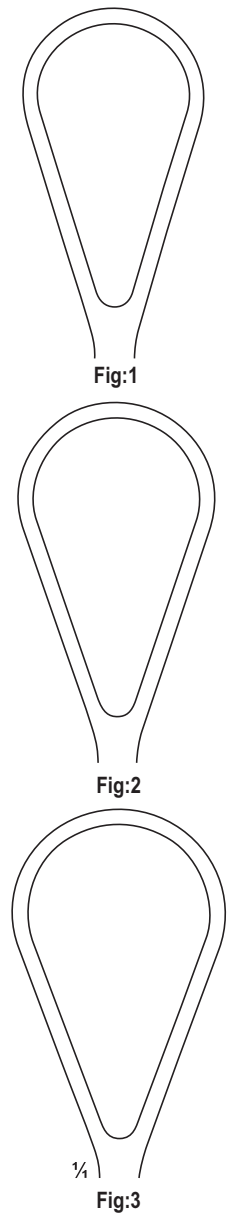

CERVICAL BIOPSY AND SPECIMEN FORCEPS

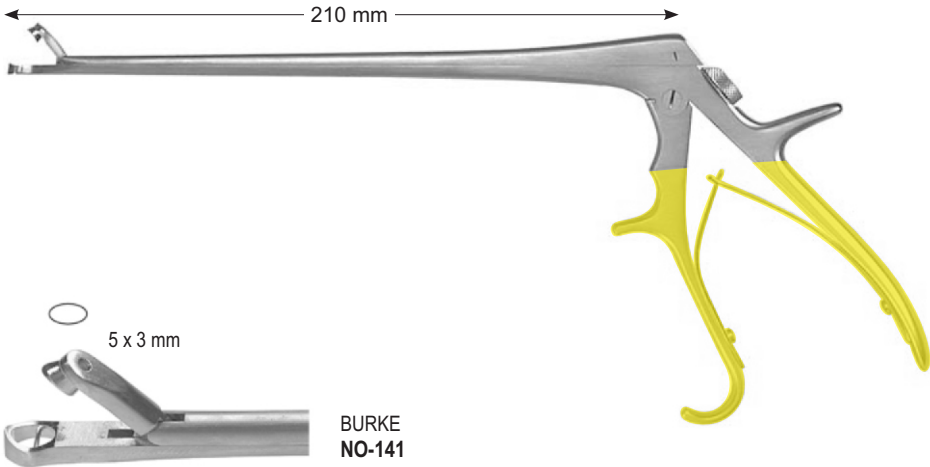

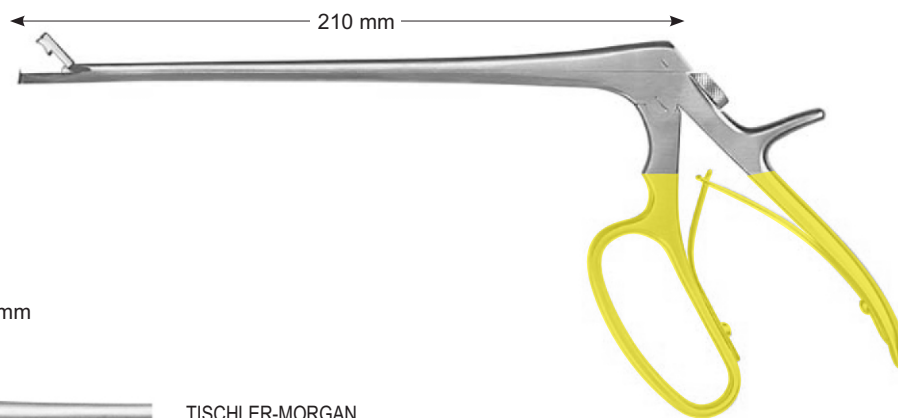

7 x 3 mm



TISCHLER-MORGAN
NO-142

2.3 x 4 mm



MINI-TOWNSEND
NO-143

9 x 3 mm



TISCHLER-KEVORKIAN
NO-145

2.3 x 4 mm



BABY-TISCHLER
NO-144

9 x 3 mm



KEVORKIAN-PACIFIC
NO-146

Page 312-374

- Cardiovascular And Thoracic Surgery
- Muller Vessel Clips
- Bulldog Clamps

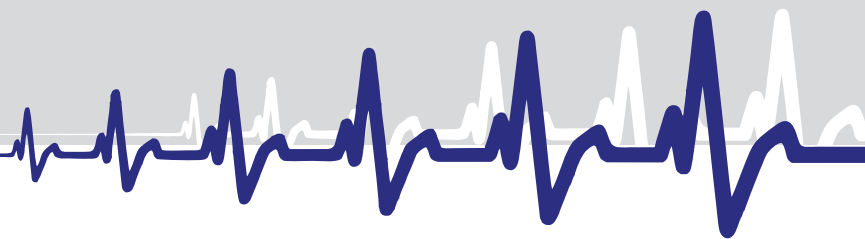

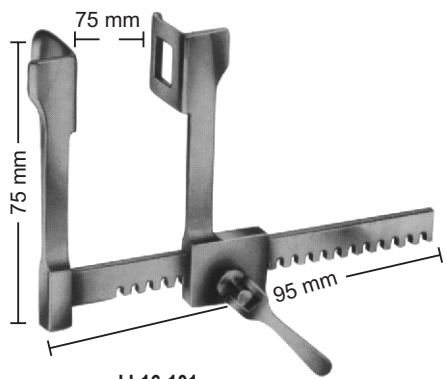

JJ-16-101
FINOCHIETTO
for children
18X21 mm

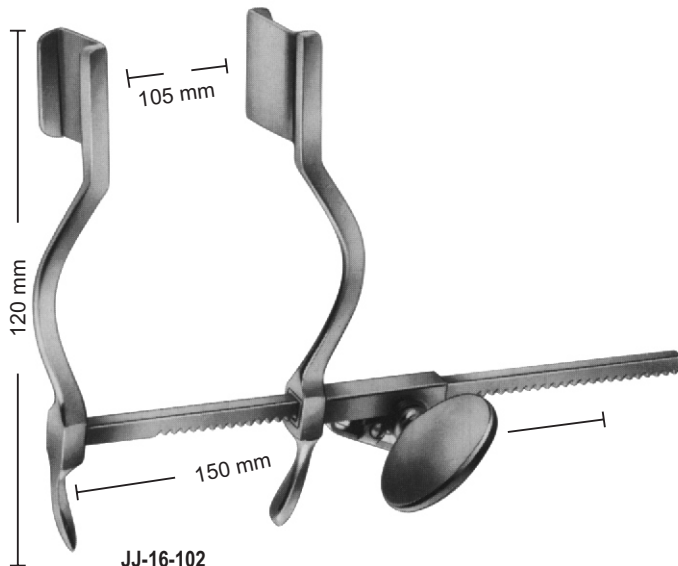

JJ-16-102
HERTZLER
for children
20X25 mm

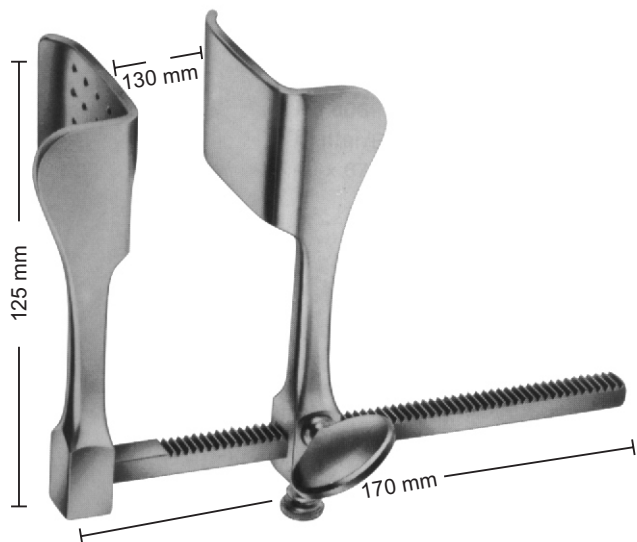

JJ-16-103
TUFFIER
Blades
43X53 mm

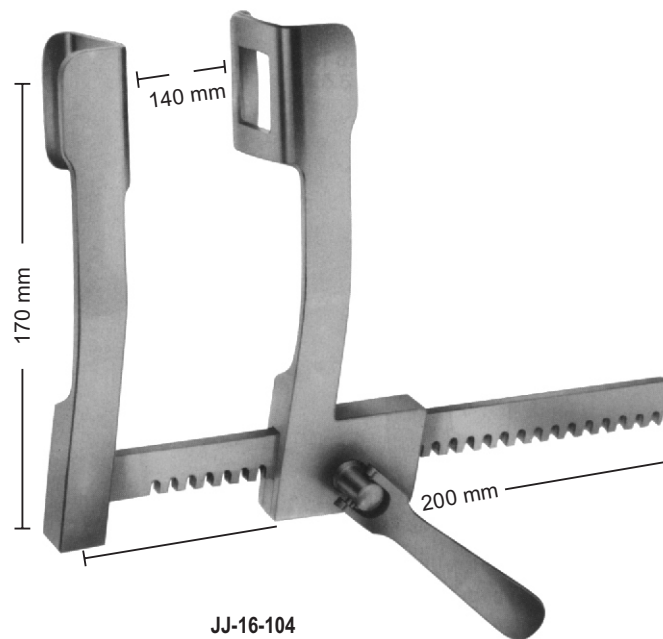

JJ-16-104
FINOCHIETTO
Blades
36X45 mm

RIB SPREADERS

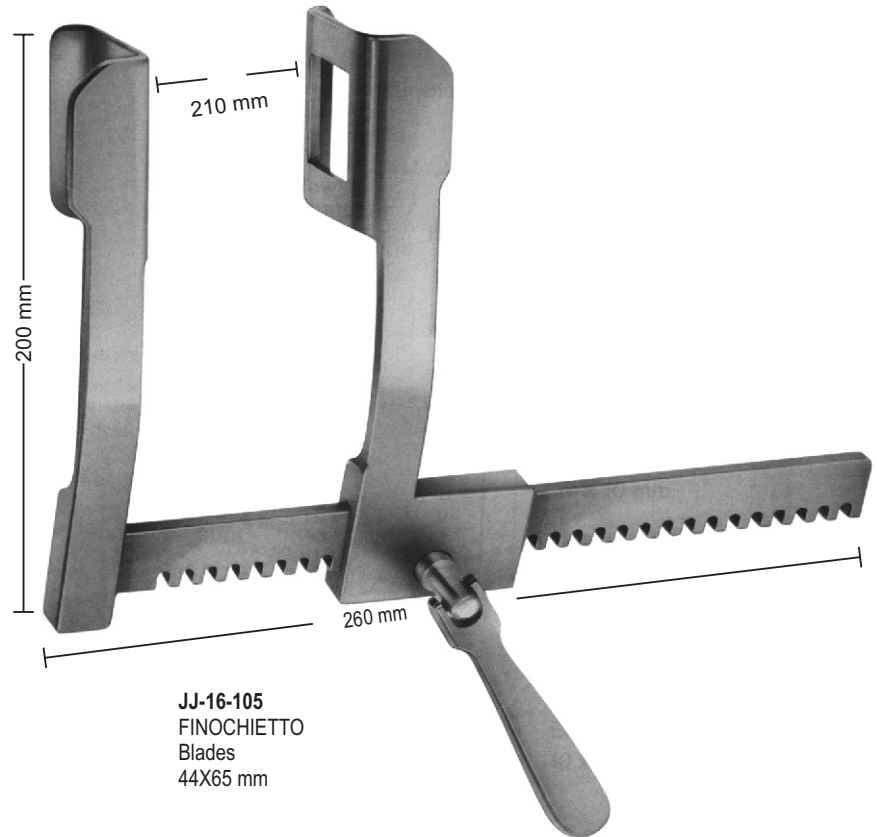

JJ-16-105
FINOCHIETTO
Blades
44X65 mm

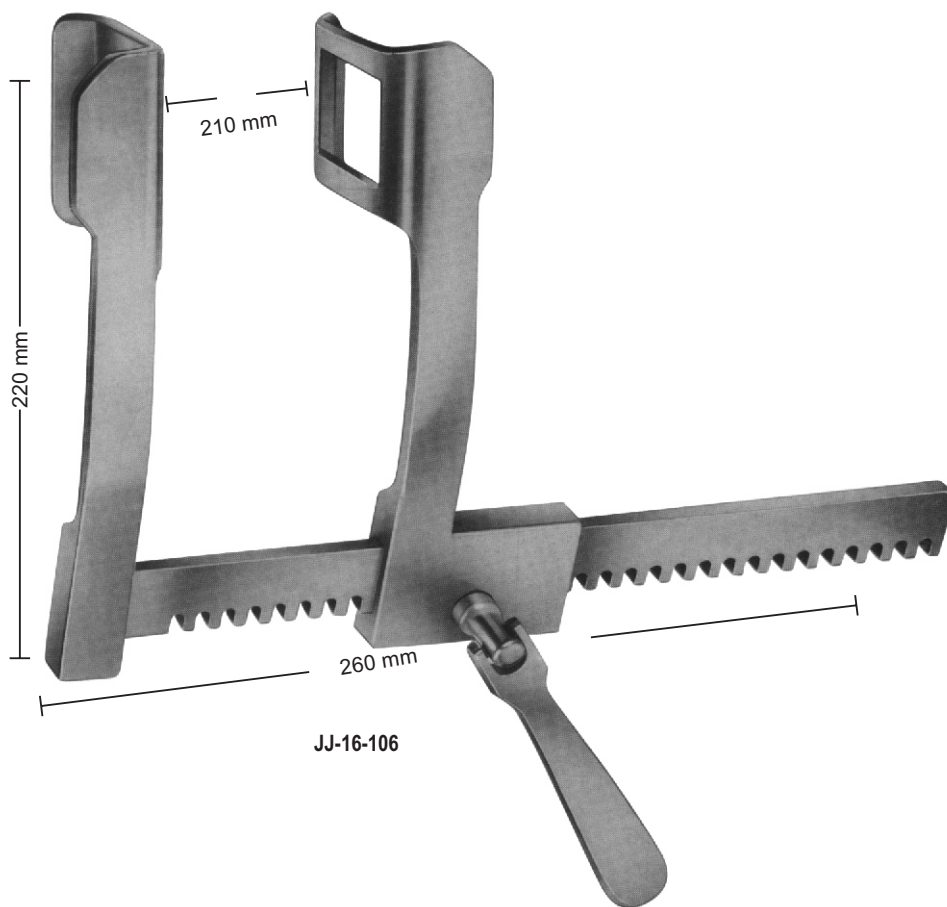

JJ-16-106

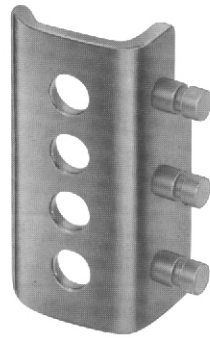

JJ-16-107
Blades
46x67 mm

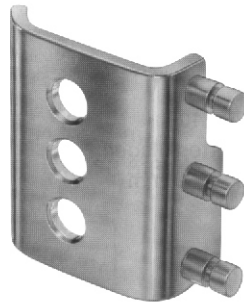

JJ-16-108
Blades
80x67 mm

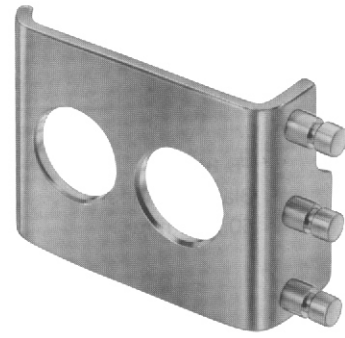

JJ-16-109
Blades
46x67 mm

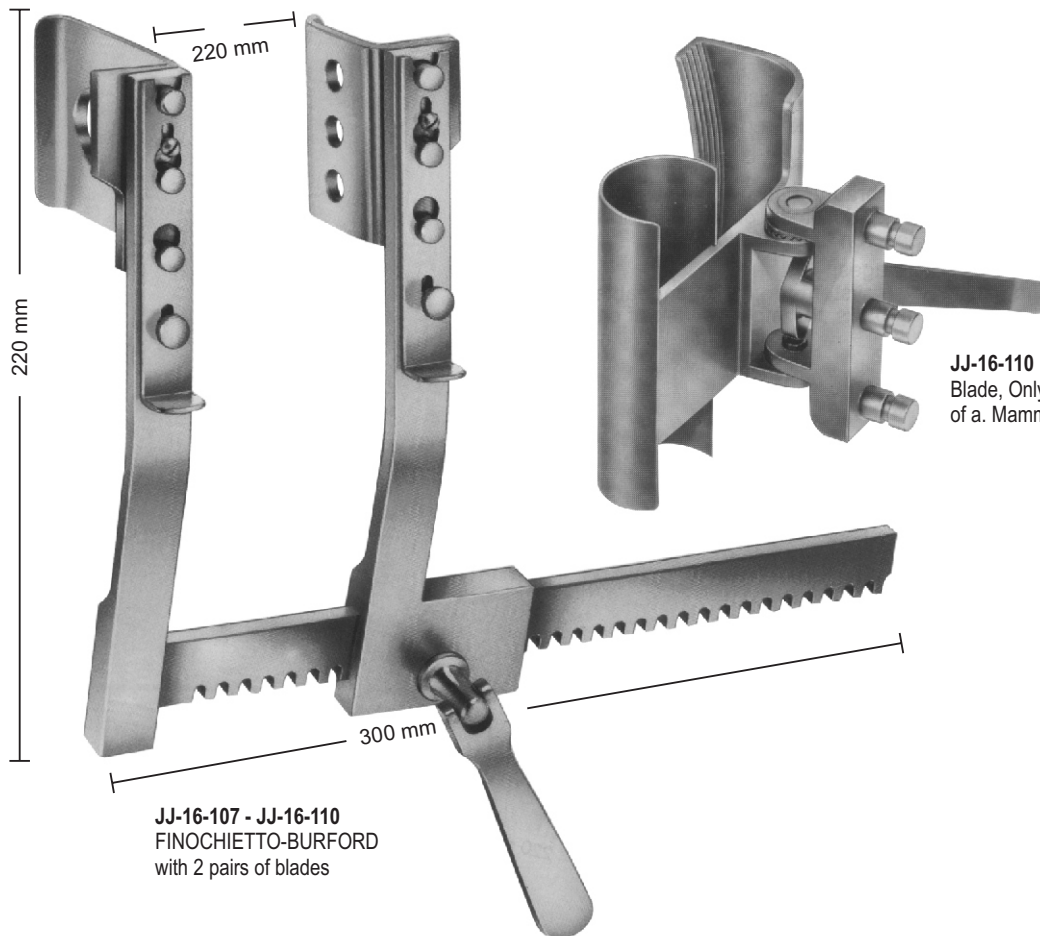
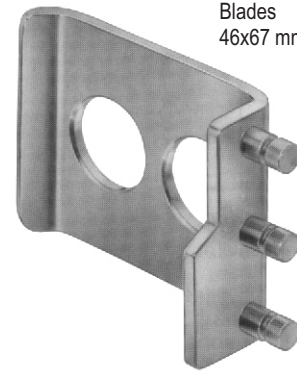
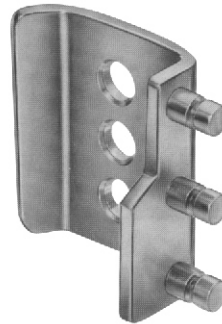
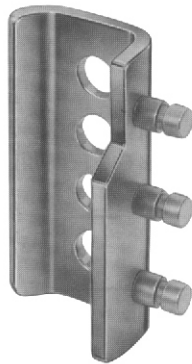

JJ-16-110
Blade, Only, for preparation
of a. Mammaria, 25.5x80mm

JJ-16-107 - JJ-16-110
FINOCHIETTO-BURFORD
with 2 pairs of blades

RIB SPREADERS

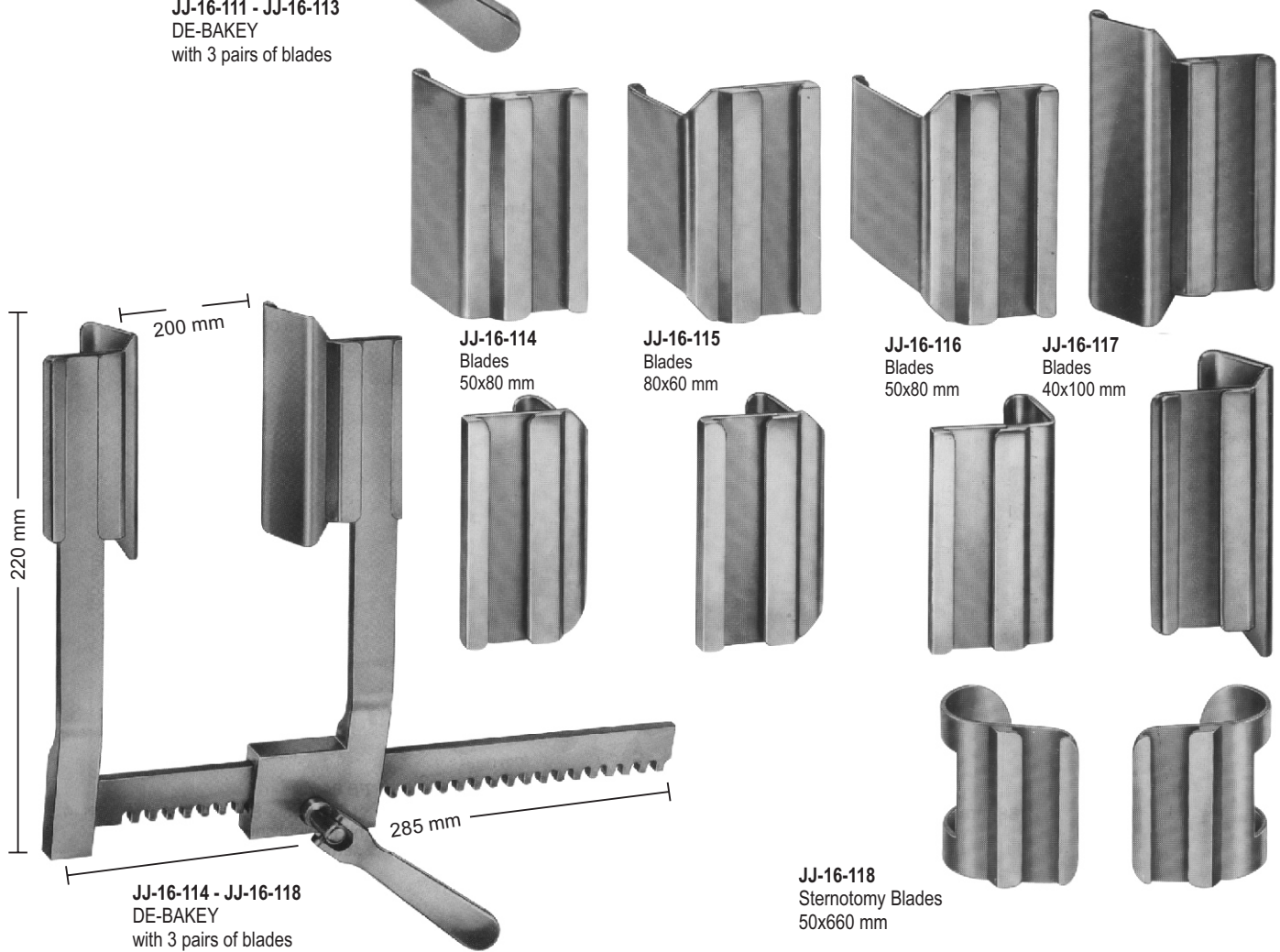
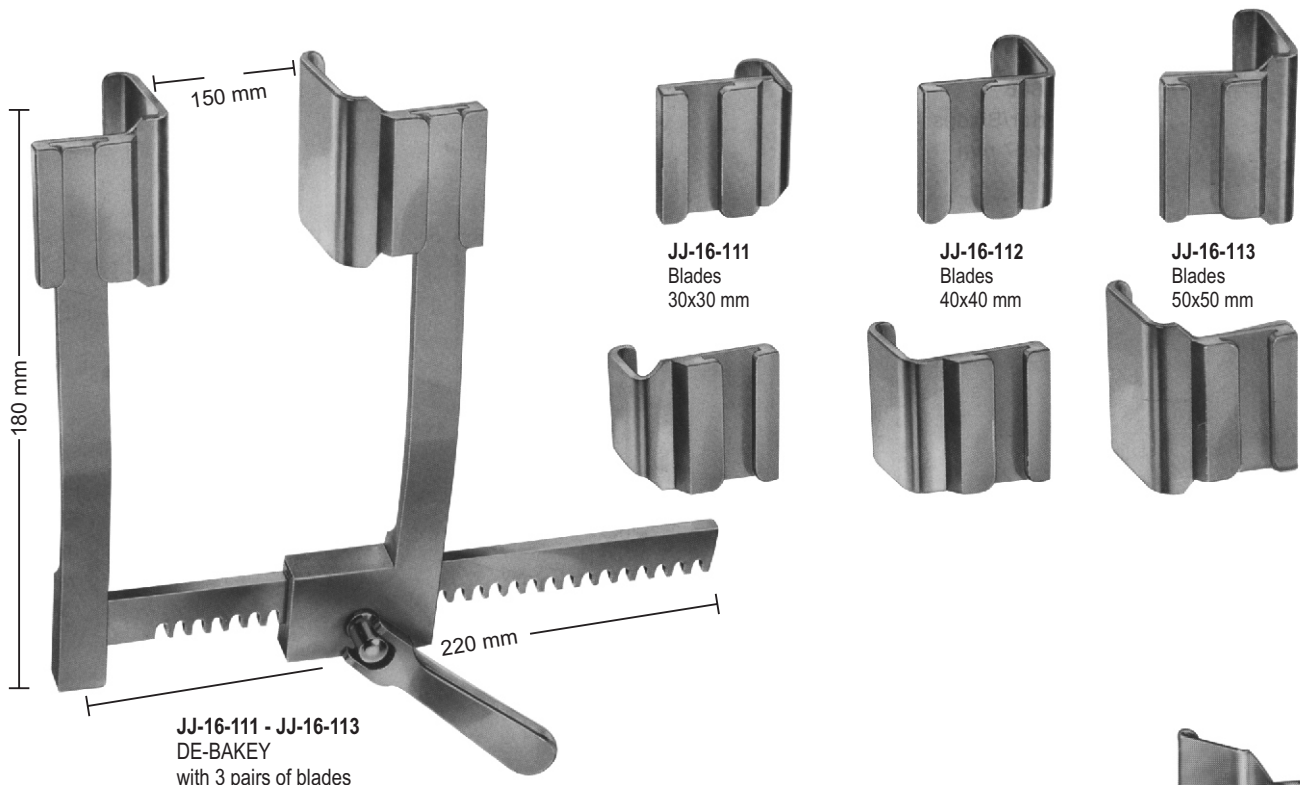

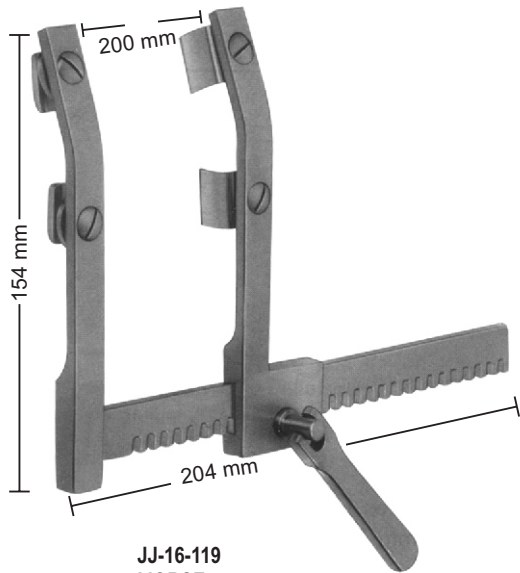

JJ-16-119
MORSE
Sternotomy spreader
for children, with moveable
double, each blade
12x20 mm

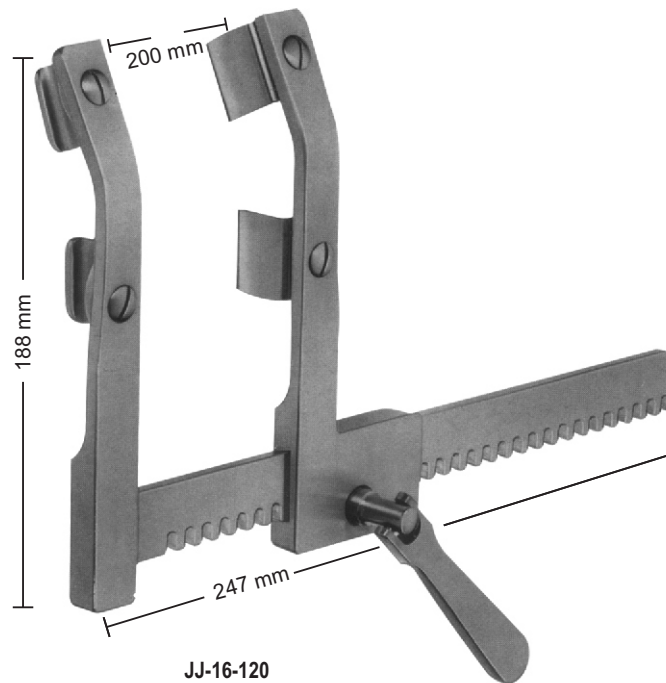

JJ-16-120
MORSE
Sternotomy spreader
for adults, with moveable
double, each blade
19x19 mm

STERNUM-SPREADERS

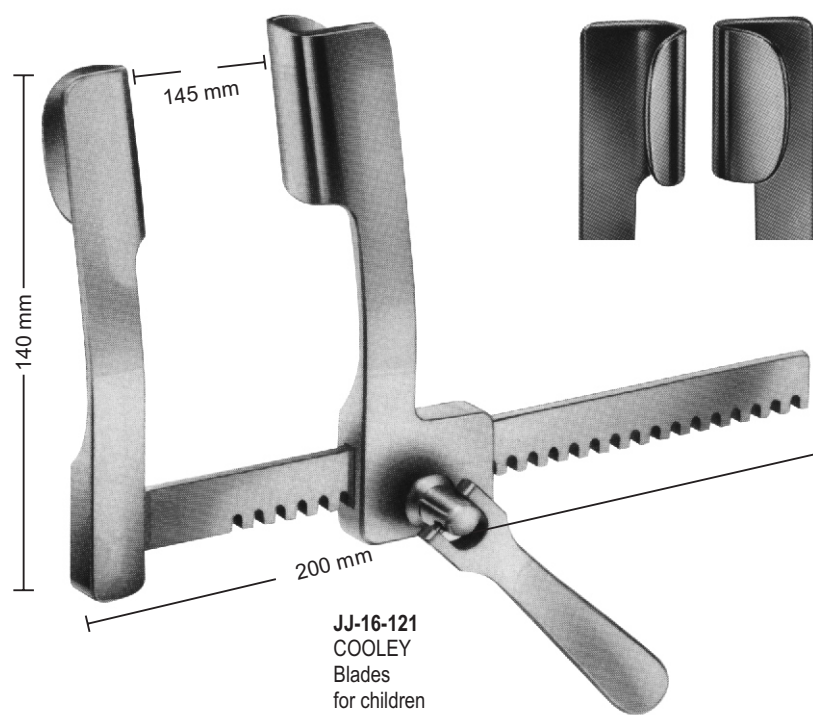

JJ-16-121
COOLEY
Blades
for children
21x45mm

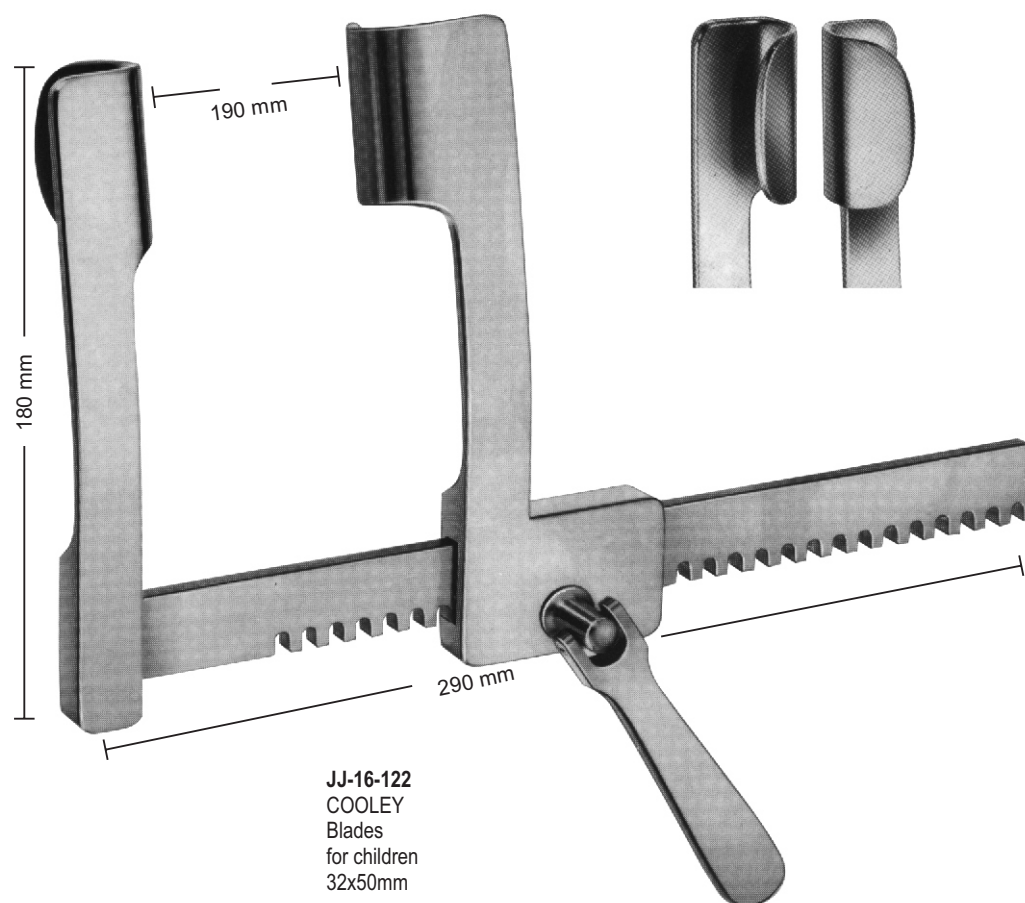

JJ-16-122
COOLEY
Blades
for children
32x50mm

STAINLESS STEEL

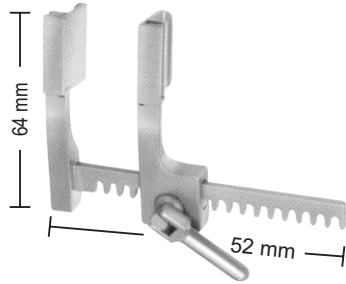

JJ-16-123 - JJ-16-124
for blades, with 2 pairs of blades
9X20 mm 9X10 mm, spreading 52 mm

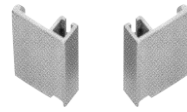

JJ-16-123
Blades, only
9x20 mm

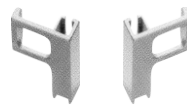

JJ-16-124
Blades, only
9x10 mm

ALUMINIUM

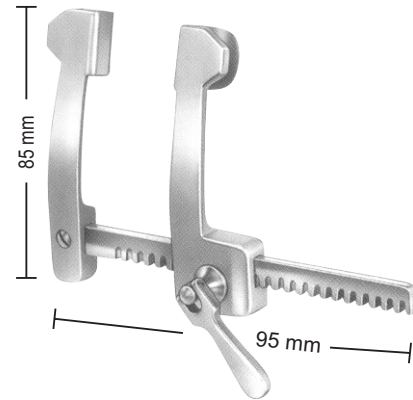

COOLEY
JJ-16-125
for blades, lateral blades 12X16 mm,
spreading 95 mm

ALUMINIUM

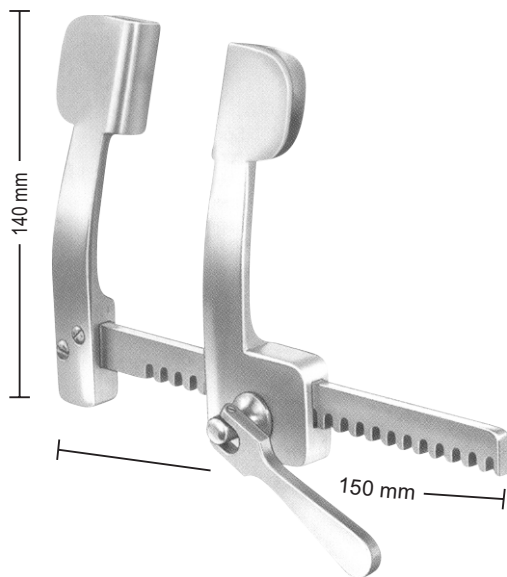

COOLEY
JJ-16-126
for children, lateral blades 21X44 mm,
spreading 150 mm

ALUMINIUM

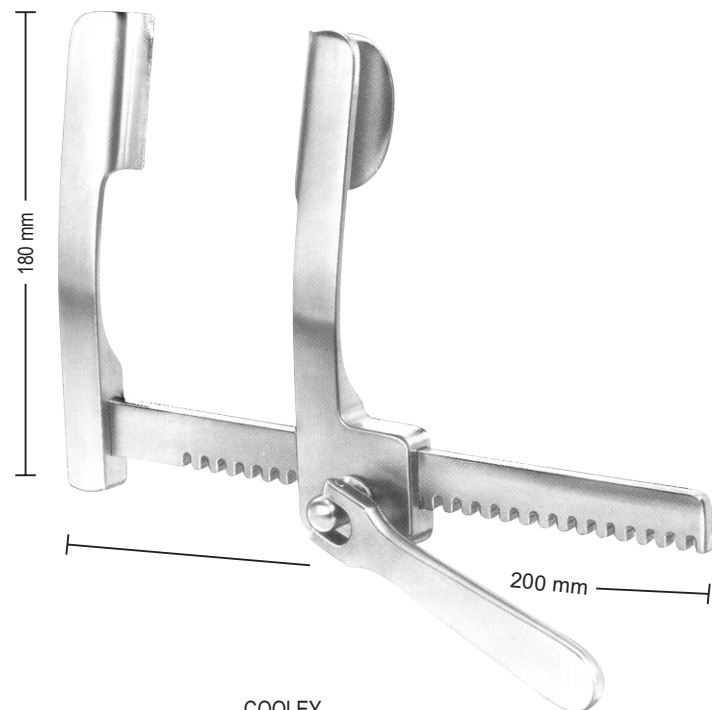

COOLEY
JJ-16-127
for adults, lateral blades 35X50 mm,
spreading 200 mm

RIB RETRACTORS

ALUMINIUM

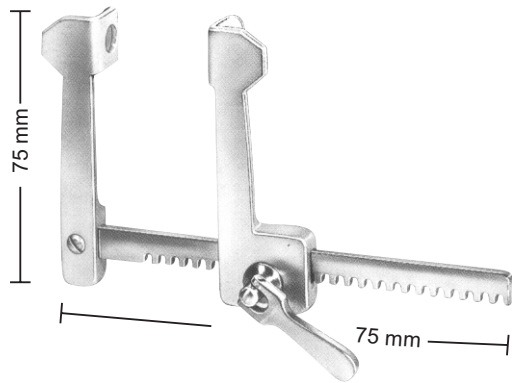

FINOCHIETTO, INFANT
JJ-16-128
for children, lateral blades 15X15 mm,
spreading 75 mm

STAINLESS STEEL

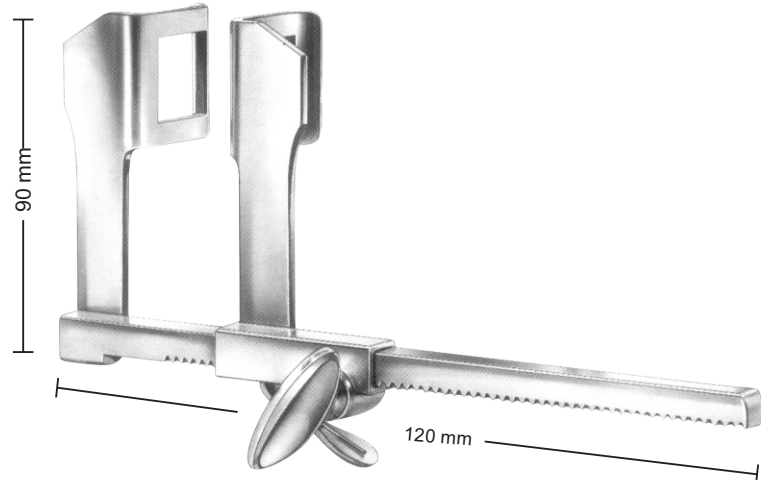

HAIGHT
JJ-16-129
lateral blades 30X30 mm,
spreading 120 mm

ALUMINIUM

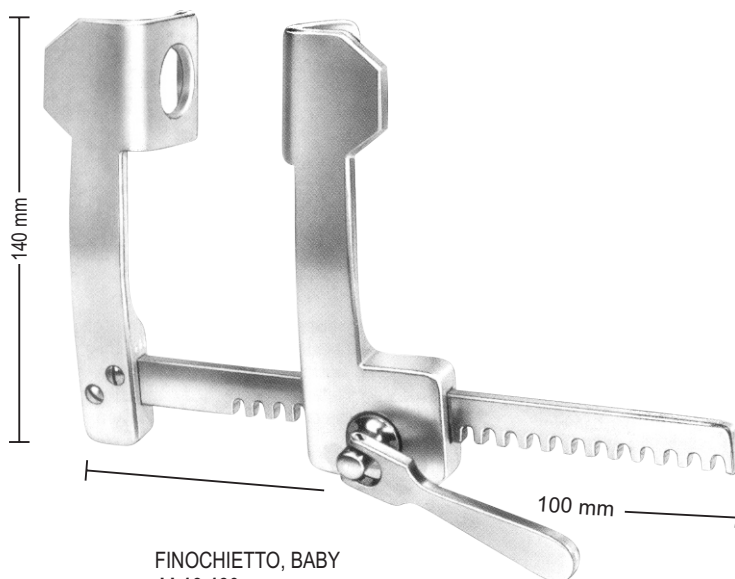

FINOCHIETTO, BABY
JJ-16-130
for children, lateral blades 31X31 mm,
spreading 100 mm

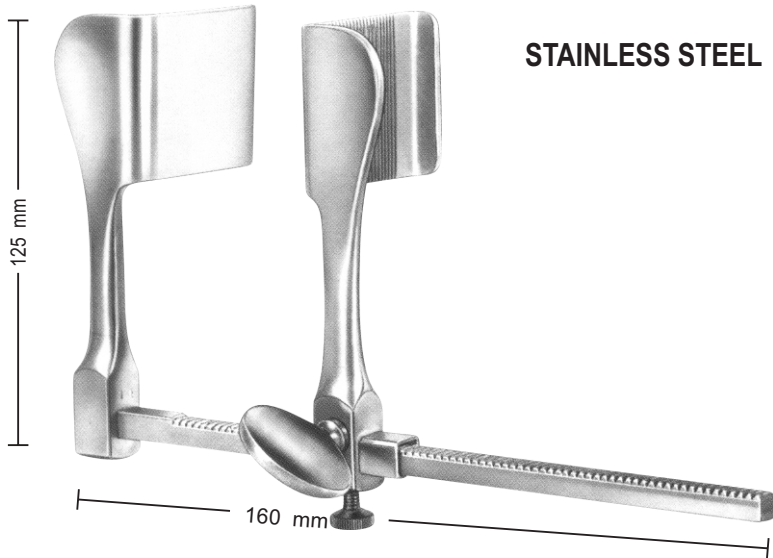

STAINLESS STEEL

TUFFIER
JJ-16-131
lateral blades 45X45 mm,
spreading 160 mm

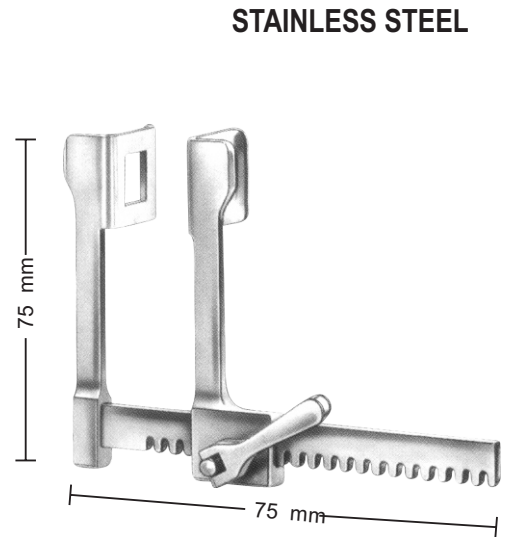

STAINLESS STEEL

FINOCHIETTO, BABY
JJ-16-132
lateral blades 14X15 mm,
spreading 75 mm

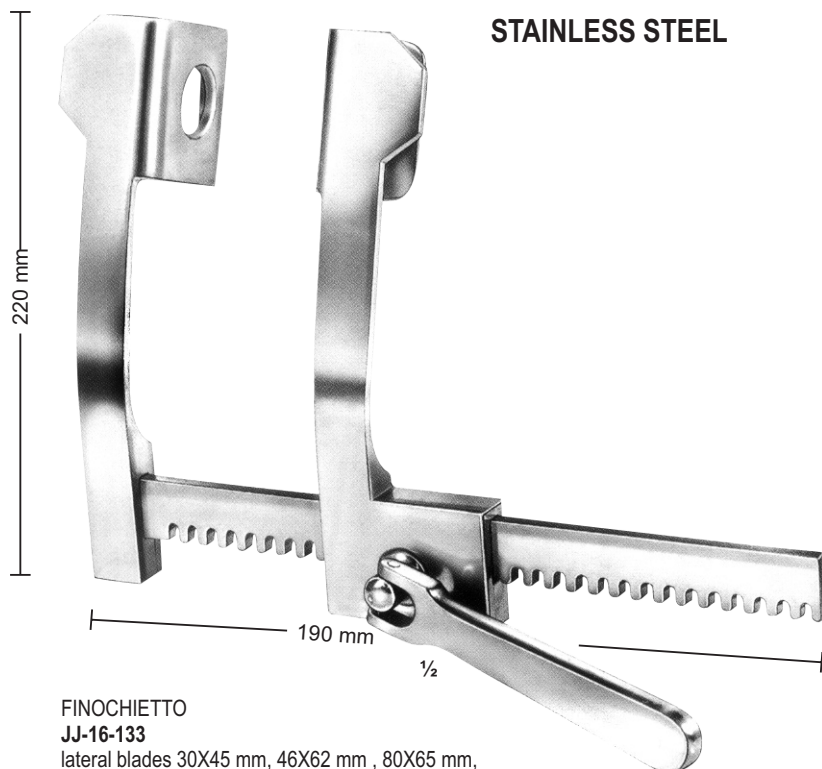

STAINLESS STEEL

FINOCHIETTO
JJ-16-133
lateral blades 30X45 mm, 46X62 mm, 80X65 mm,
spreading 150 mm, 190 mm, 190 mm

THORACIC RETRACTORS



JJ-16-135
Blades
75x75 mm

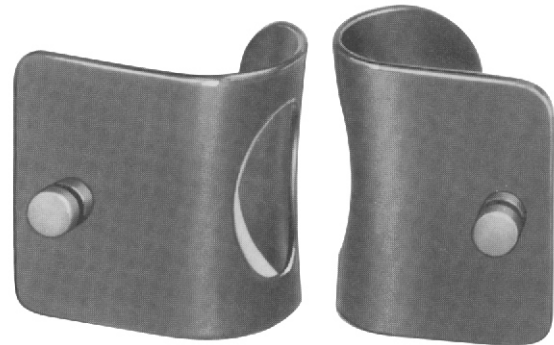

JJ-16-136
Blades
42x65 mm



Blades with Ball Snap System
Delivery: in Pairs

- JJ-16-134 - JJ-16-136**
Thoraxsperrer (Mercedes-Sperrer)
complete consisting of:
JJ-16-134 Retractor only
JJ-16-135 1 Pair of blades 42x65 mm
JJ-16-136 1 Pair of blades 75x75 mm

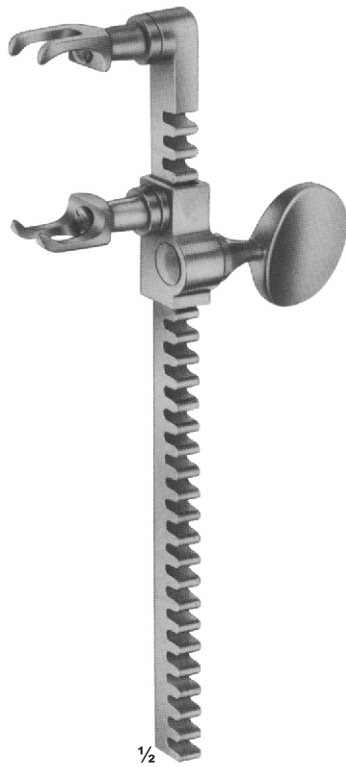

JJ-16-137
SELLORS
Rib spreader and contractor
with swivel blades
200 mm



JJ-16-138
BAILEY
150 mm



JJ-16-139
for children

JJ-16-140
for children

JJ-16-139 - JJ-16-141
BAILEY
200 mm

RING HANDLE BULLDOG CLAMPS

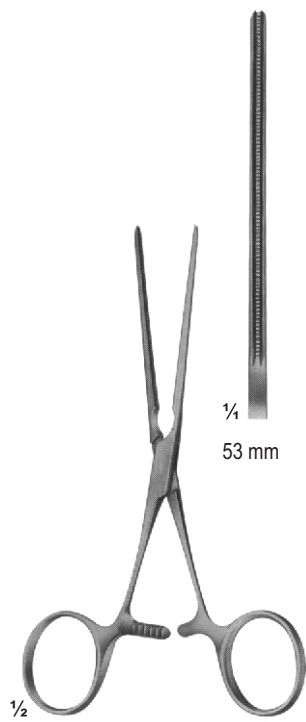

JJ-16-142
DE-BAKEY
gerade straight
130 mm

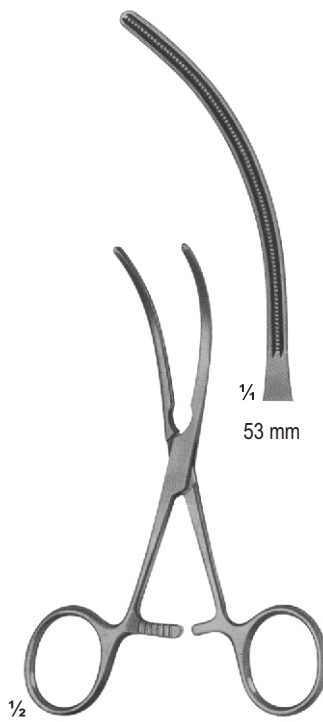

JJ-16-143
DE-BAKEY
Maul gebogen
curved jaws
125 mm

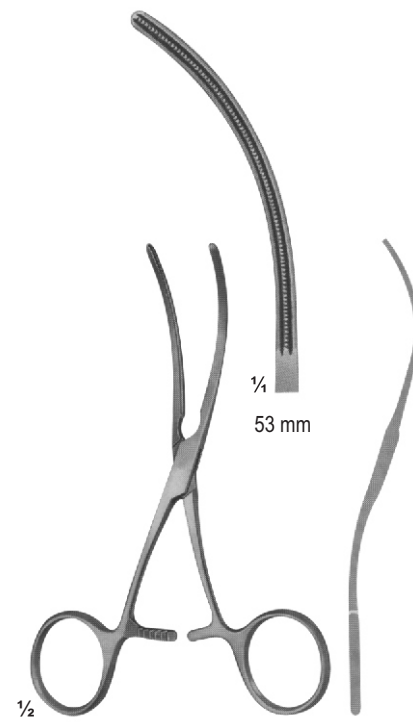

JJ-16-144
DE-BAKEY
S-shaped curved
125 mm

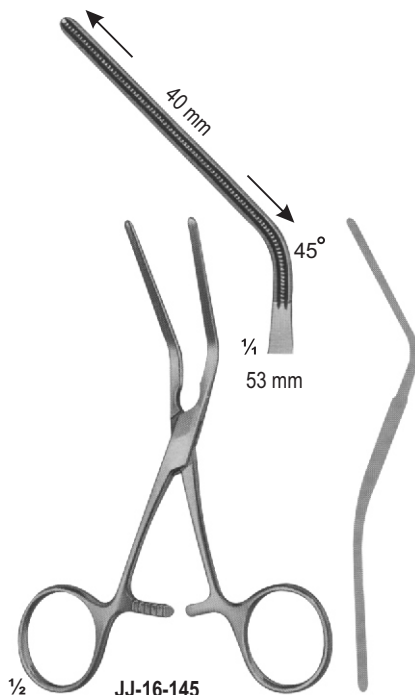

JJ-16-145
DE-BAKEY
45° winklig gebogen
angled 45°
125 mm

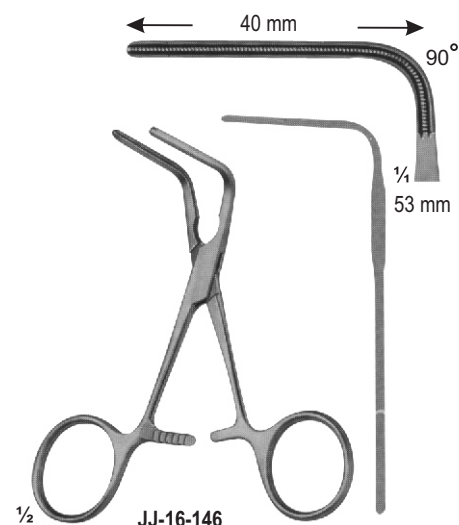

JJ-16-146
DE-BAKEY
90° winklig gebogen
angled 90°
105 mm



JJ-16-147 - JJ-16-150
CASTANESA

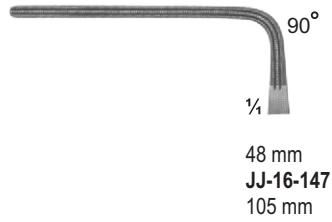

48 mm
JJ-16-147
105 mm

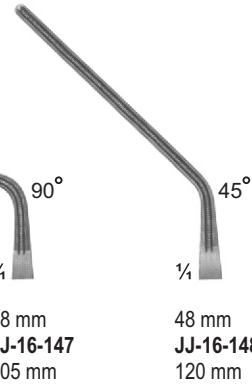

48 mm
JJ-16-148
120 mm

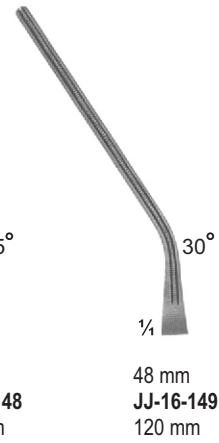

48 mm
JJ-16-149
120 mm



48 mm
JJ-16-150
125 mm



JJ-16-151 - JJ-16-154
CASTANESA

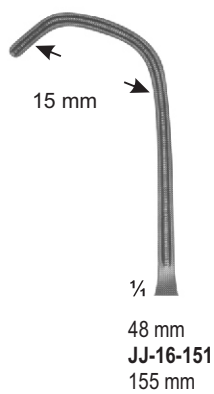

48 mm
JJ-16-151
155 mm

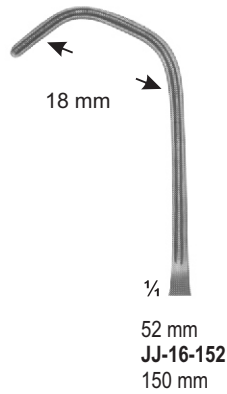

52 mm
JJ-16-152
150 mm

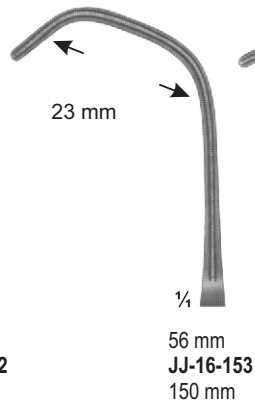

56 mm
JJ-16-153
150 mm

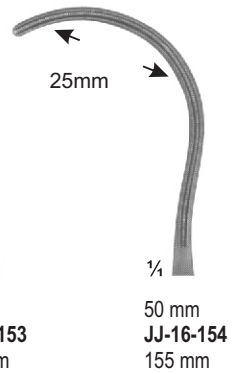

50 mm
JJ-16-154
155 mm

ANASTOMOSIS AND MULTI-PURPOSE-CLAMPS-PEDIATRIC TYPES

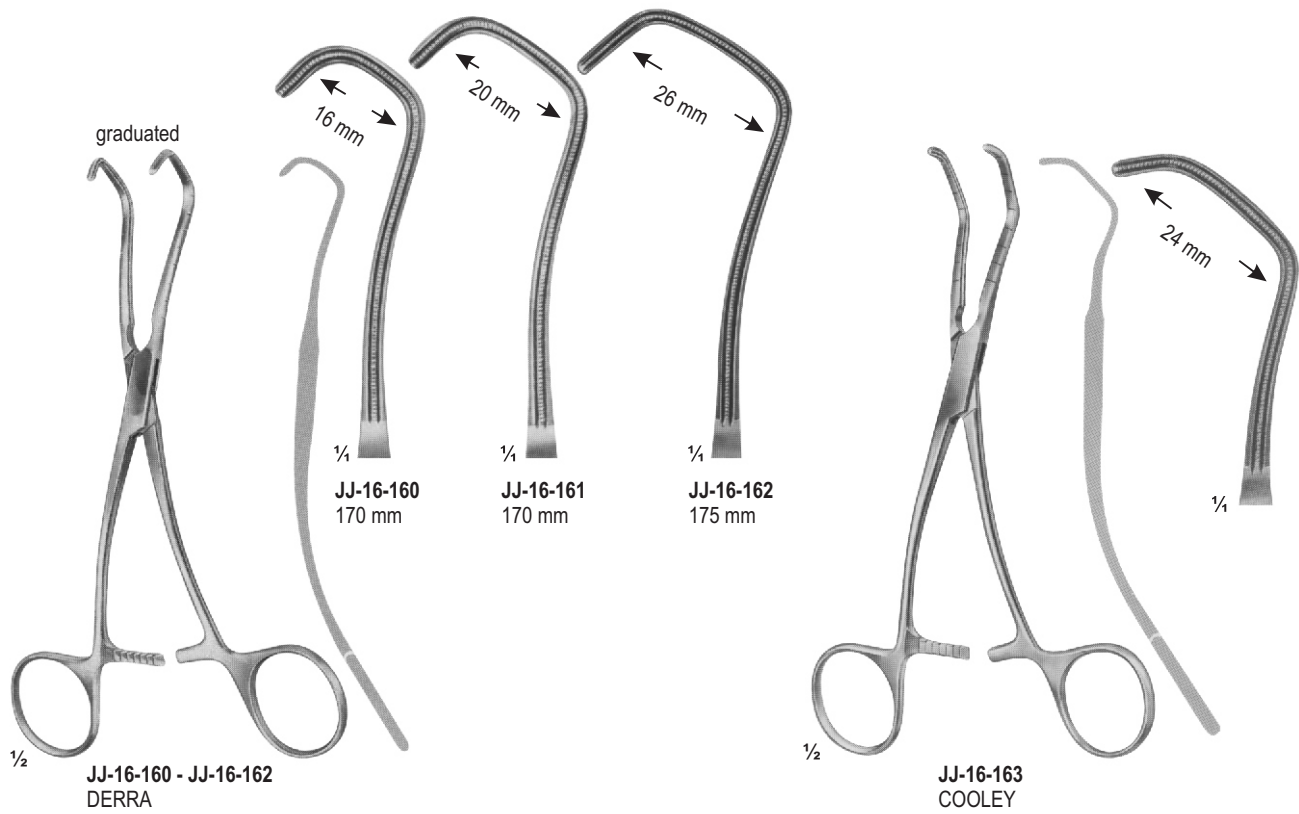
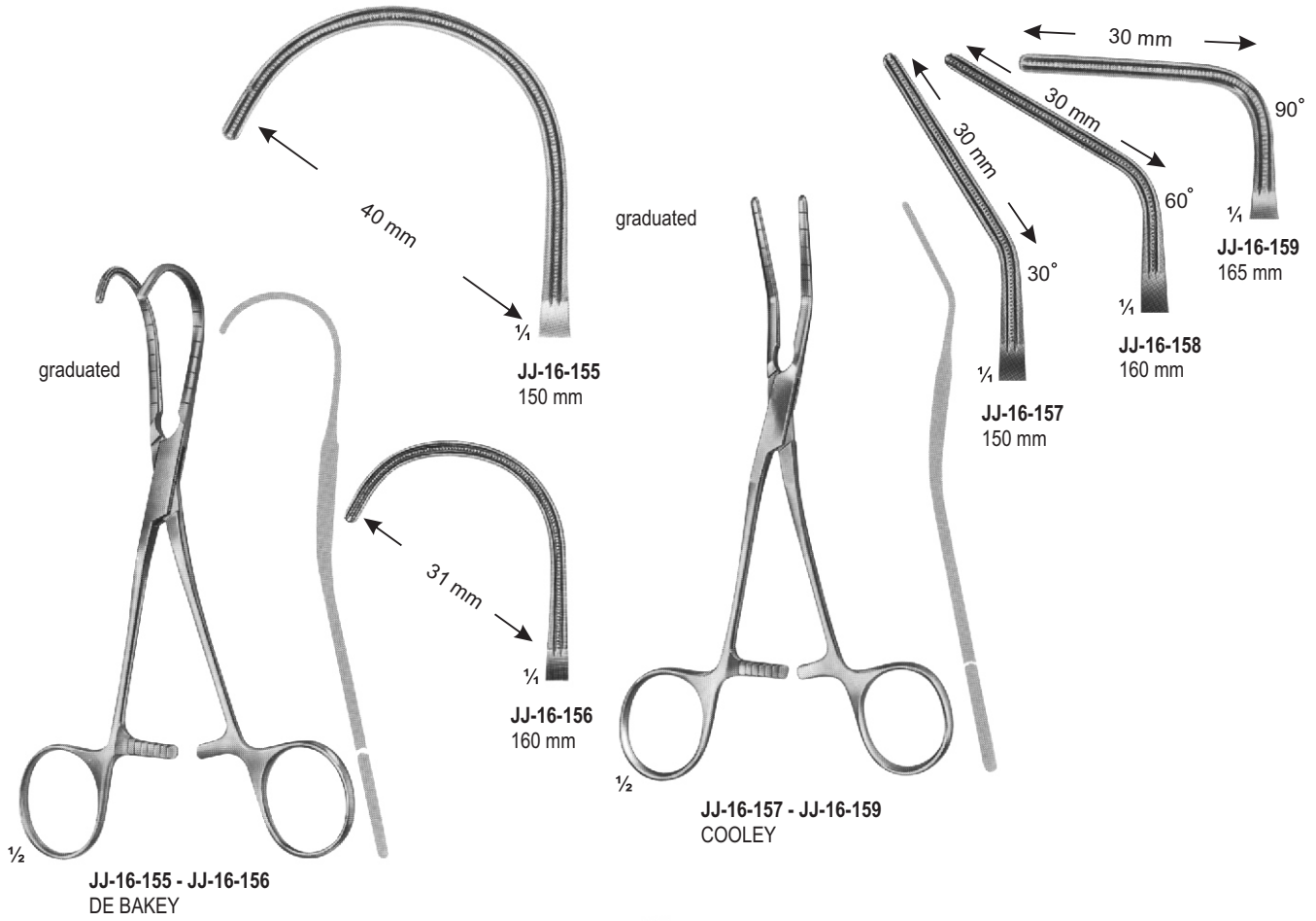

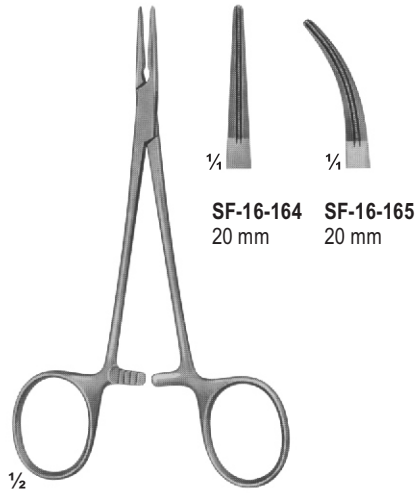

JJ-16-164 - JJ-16-165
HALSTED
125 mm

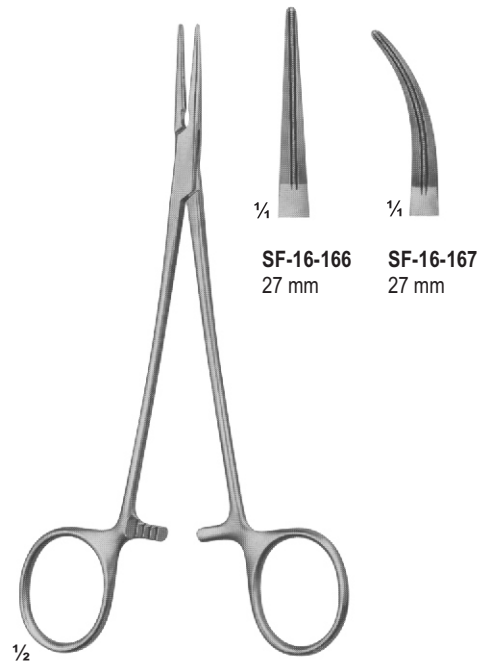

JJ-16-166 - JJ-16-167
RANKIN
165 mm

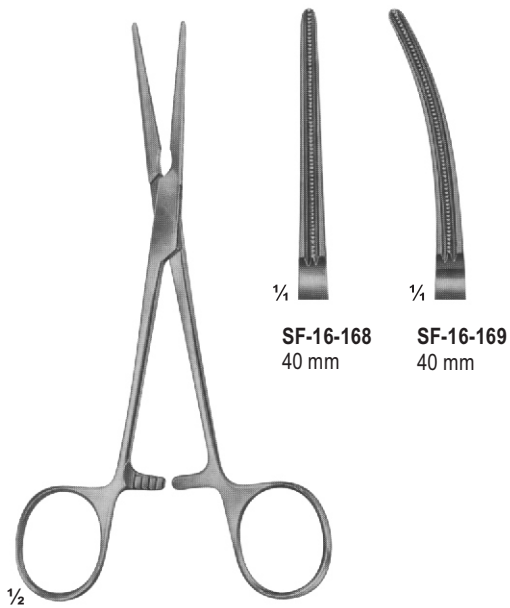

JJ-16-168 - JJ-16-169
DE BAKEY-BAINRIDGE
155 mm

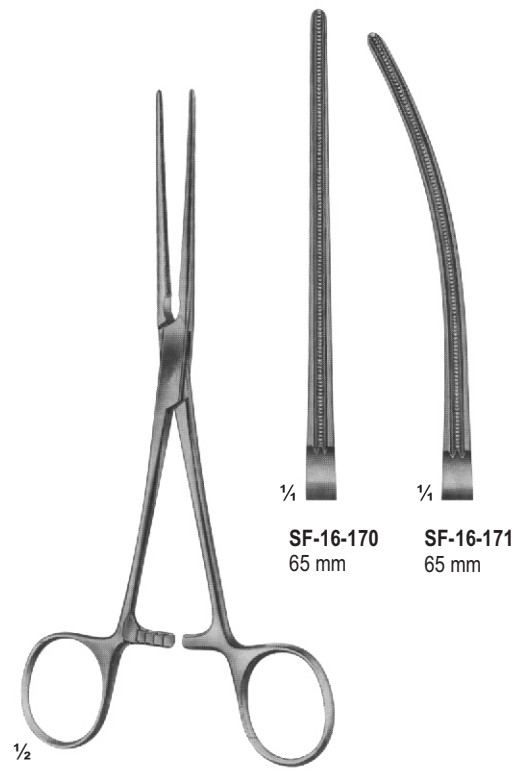

JJ-16-170 - JJ-16-171
DE BAKEY-BAINRIDGE
180 mm

NON-TRAUMATIC HAEMOSTATIC FORCEPS

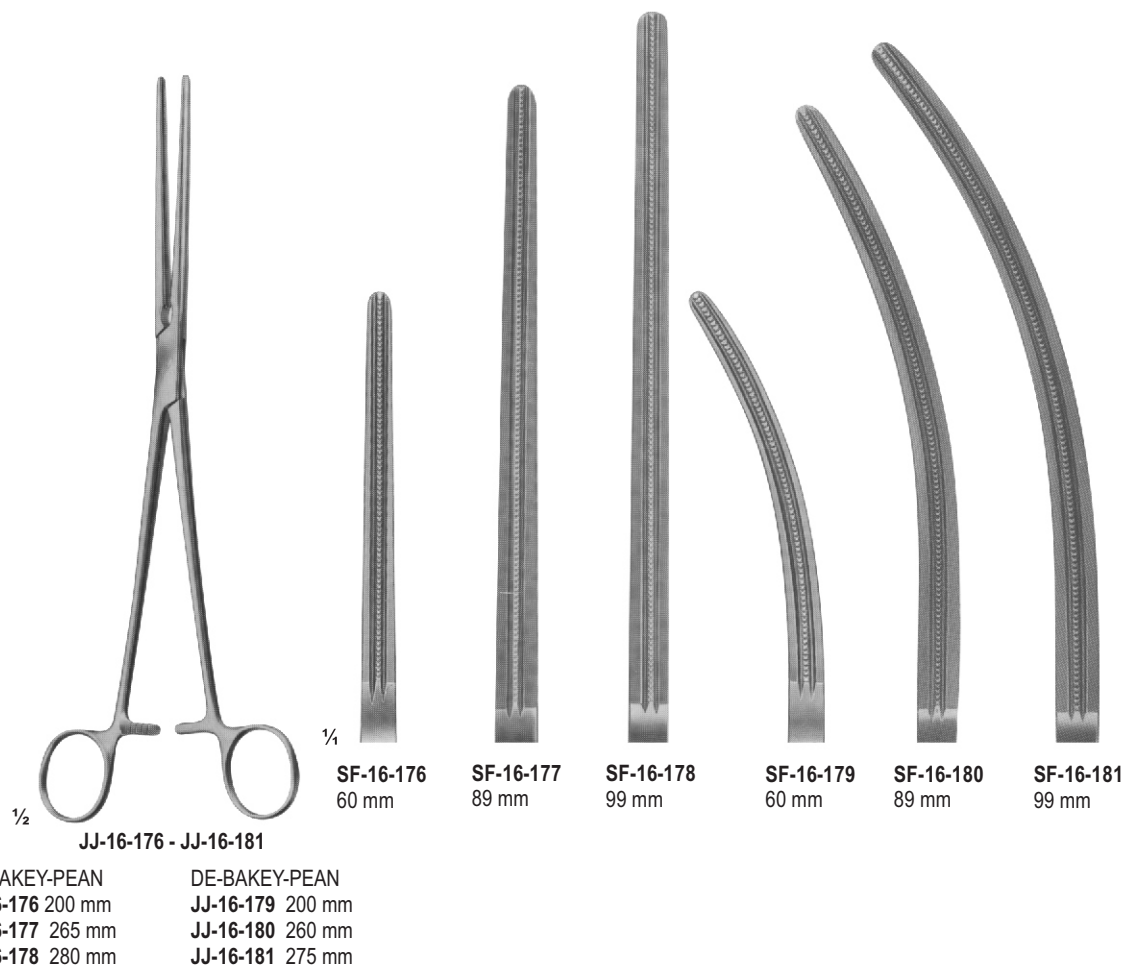
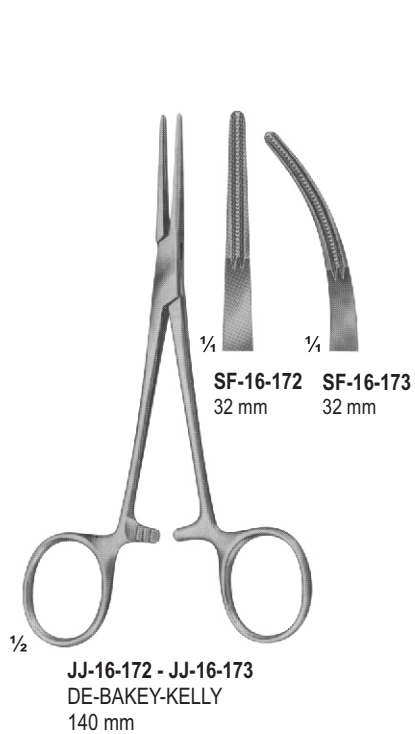

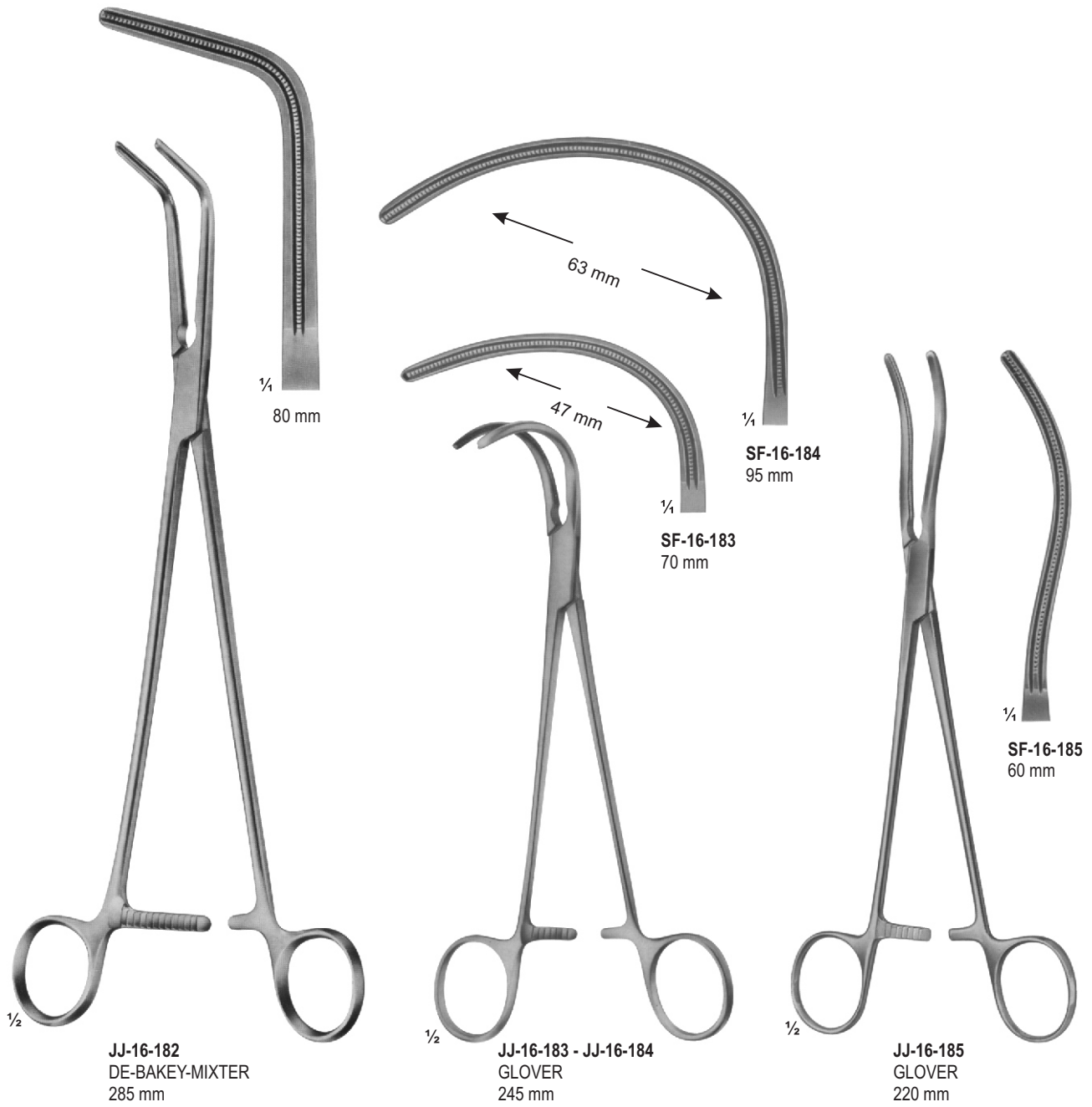

VENA-CAVA CLAMPS

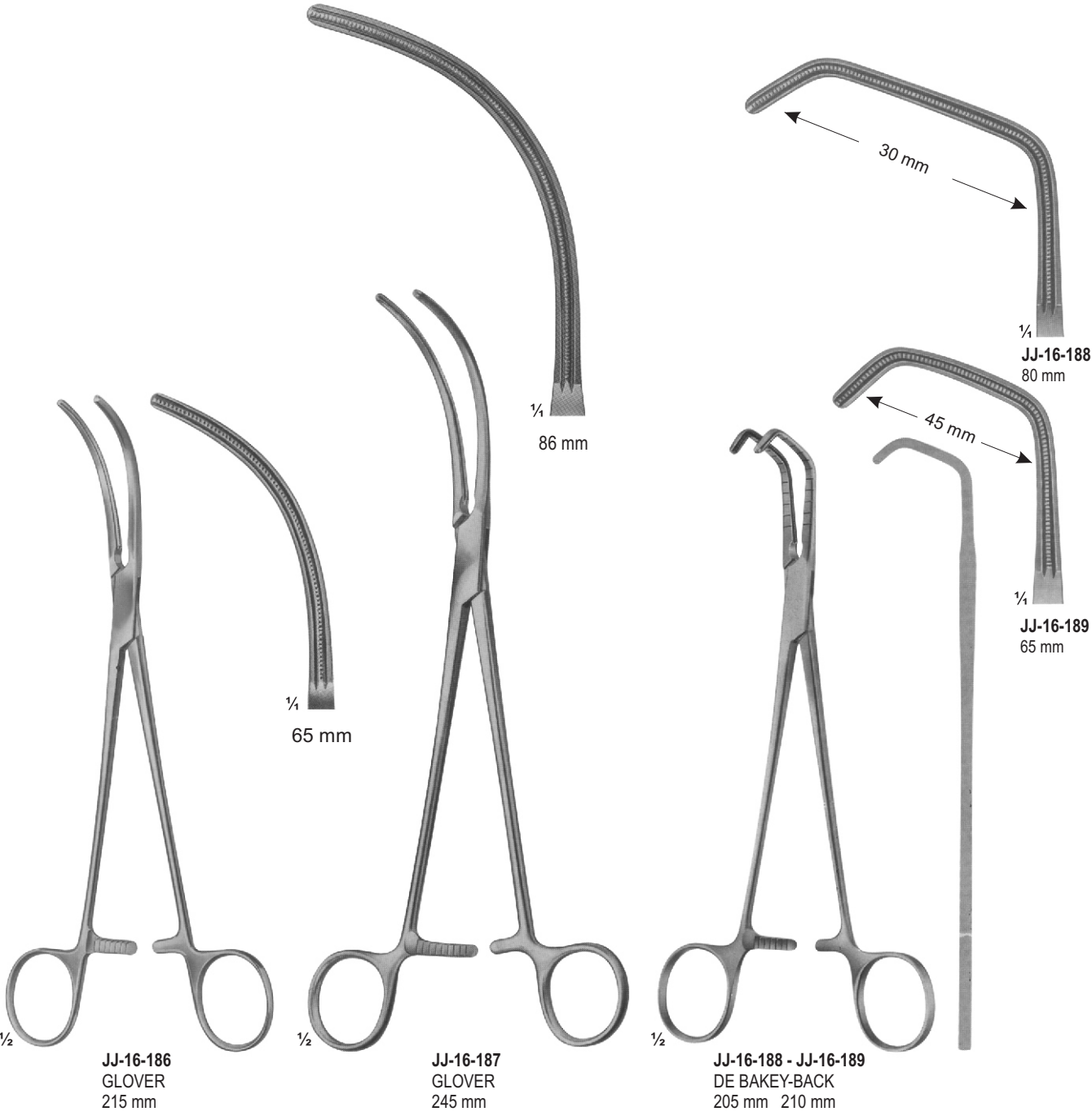



1/2



1/4
JJ-16-190
86 mm

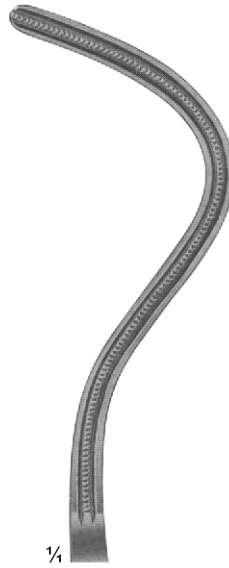

1/4
JJ-16-191
86 mm

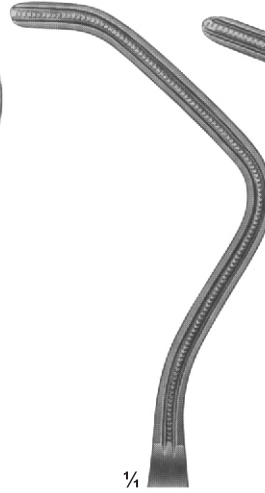

1/4
JJ-16-192
86 mm

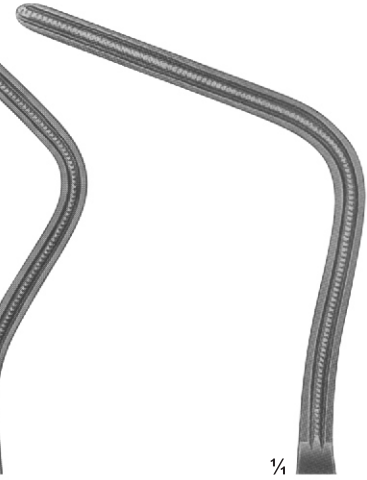

1/4
JJ-16-193
86 mm

JJ-16-190 - JJ-16-193
DE BAKEY-HARKEN
JJ-16-190 - 255 mm
JJ-16-191 - 245 mm
JJ-16-192 - 245 mm
JJ-16-193 - 245 mm



1/2

JJ-16-194 - JJ-16-198
DE BAKEY

Total Length:
Length of jaws:

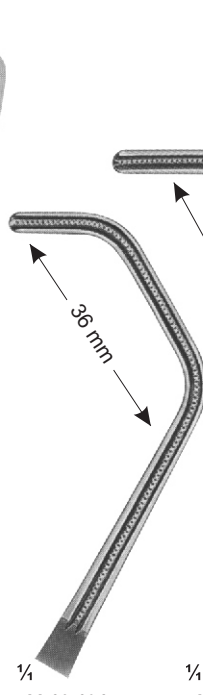

1/4
JJ-16-194
220 mm
85 mm

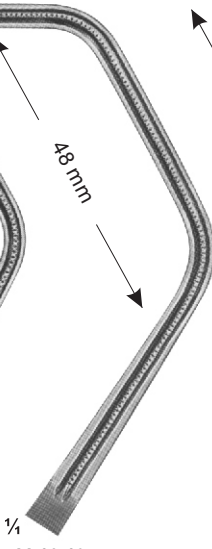

1/4
JJ-16-195
256 mm
95 mm

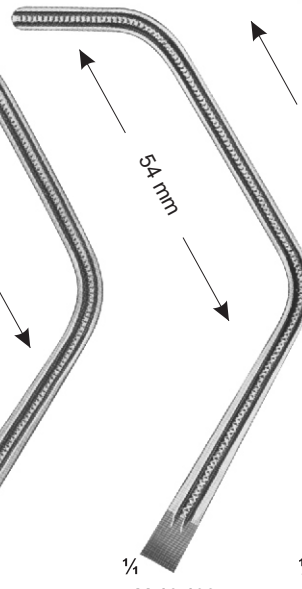

1/4
JJ-16-196
270 mm
99 mm

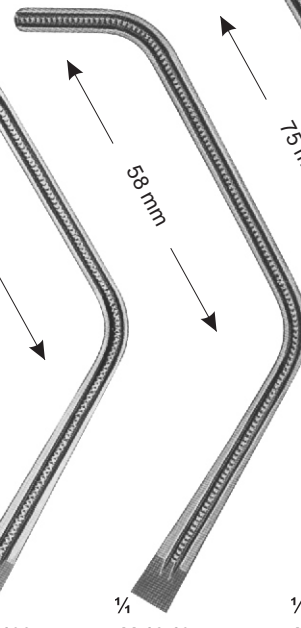

1/4
JJ-16-197
270 mm
103 mm

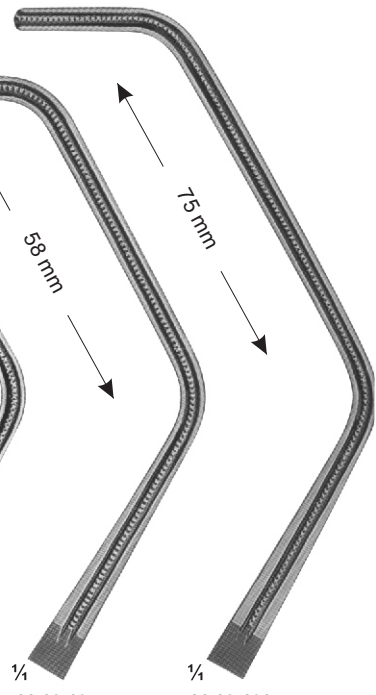

1/4
JJ-16-198
280 mm
119 mm

NON-TRAUMATIC HAEMOSTATIC FORCEPS

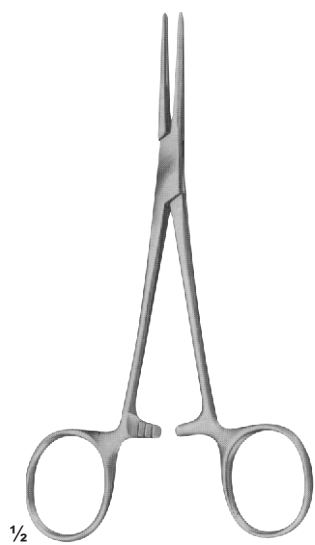

1/2

DE-BAKEY-KELLY
JJ-16-199 - JJ-16-200
 140 mm



1/4

SF-16-199
 32 mm



1/4

SF-16-200
 32 mm



1/2

PEAN
JJ-16-201 - JJ-16-202
 155 mm



1/4

SF-16-201
 50 mm



1/4

SF-16-202
 50 mm



1/2

JJ-16-203 - JJ-16-208

- | | |
|-------------------------|-------------------------|
| DE-BAKEY-PEAN | DE-BAKEY-PEAN |
| JJ-16-203 200 mm | JJ-16-206 200 mm |
| JJ-16-204 265 mm | JJ-16-207 260 mm |
| JJ-16-205 280 mm | JJ-16-208 275 mm |



1/4

SF-16-203
 60 mm



SF-16-204
 89 mm

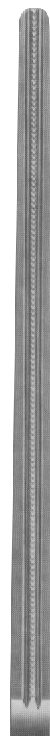

SF-16-205
 99 mm

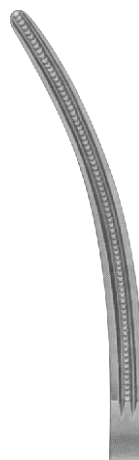

SF-16-206
 60 mm

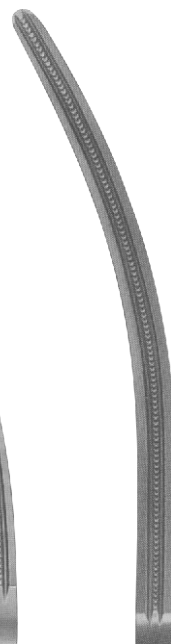

SF-16-207
 89 mm

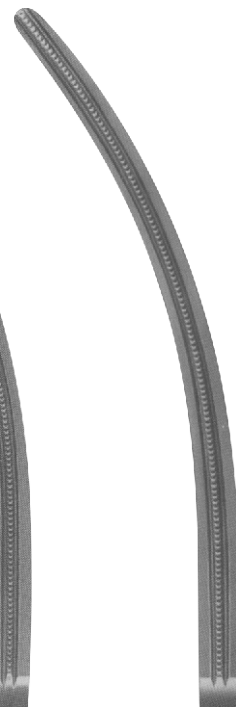

SF-16-208
 99 mm

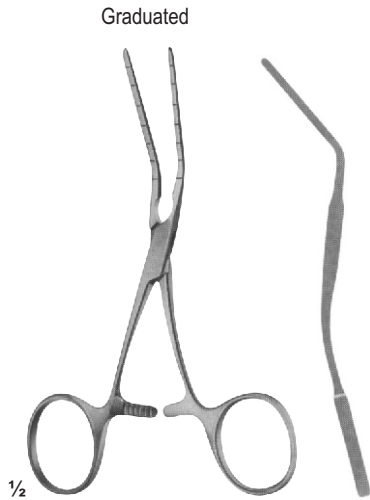

CASTANEDA
JJ-16-209 - JJ-16-212

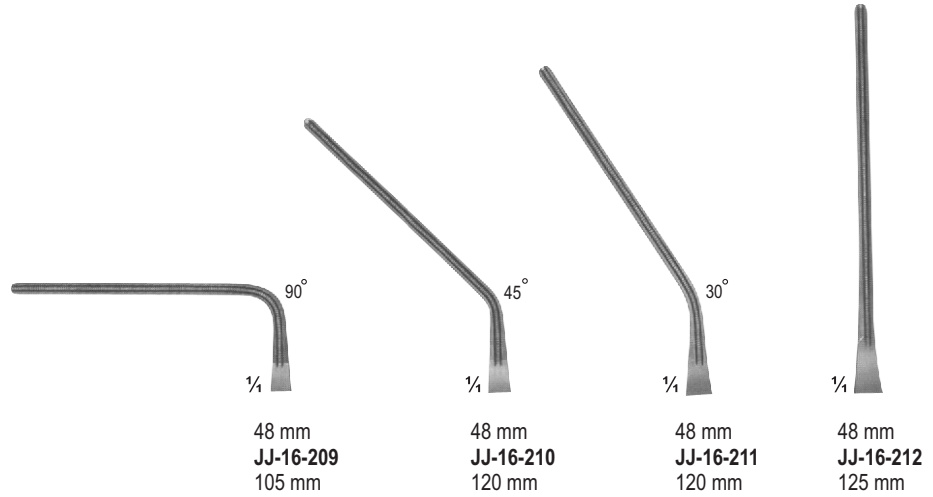

CASTANEDA
JJ-16-213 - JJ-16-216

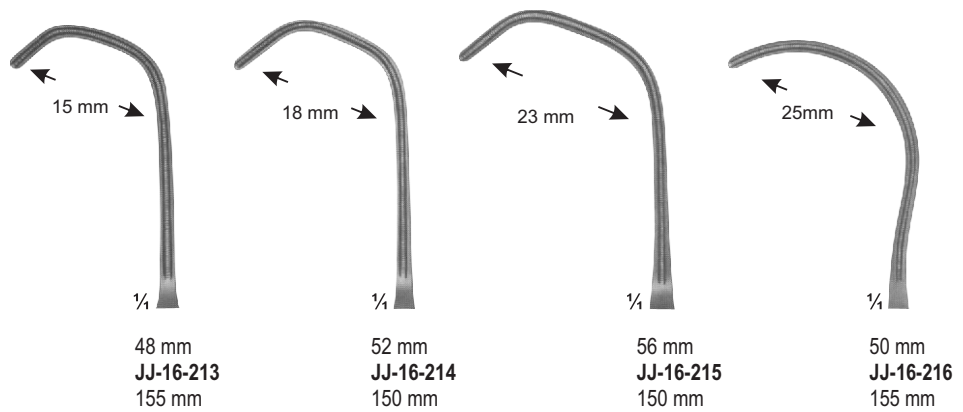

ANASTOMOSIS CLAMPS & VENA-CAVA CLAMPS

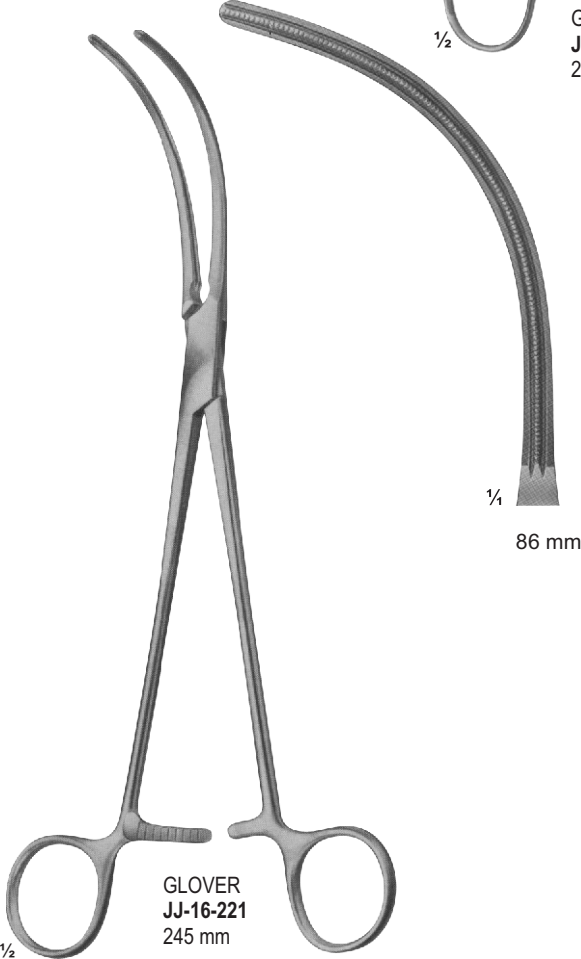
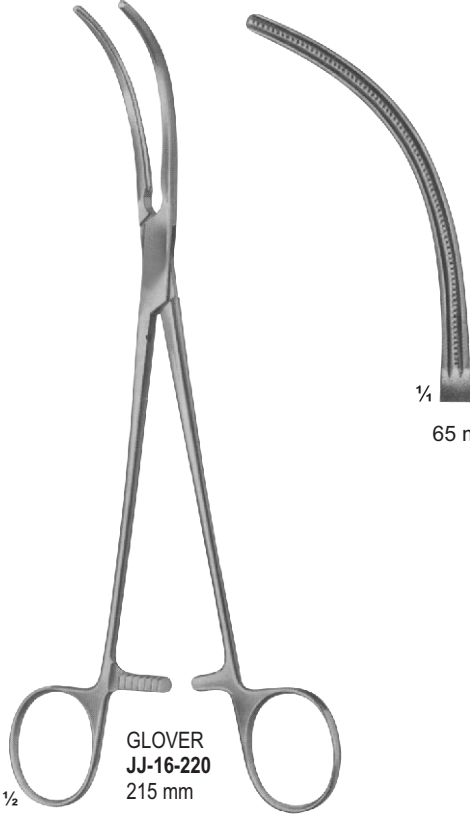
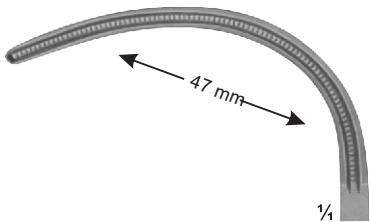
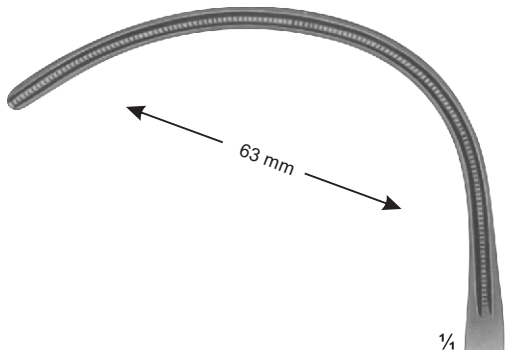



1/2

DE BAKEY-BACK
JJ-16-222 20.5 cm
JJ-16-223 21 cm

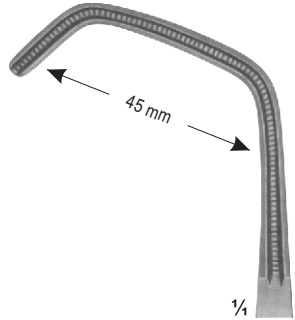

1/4

JJ-16-222
65 mm

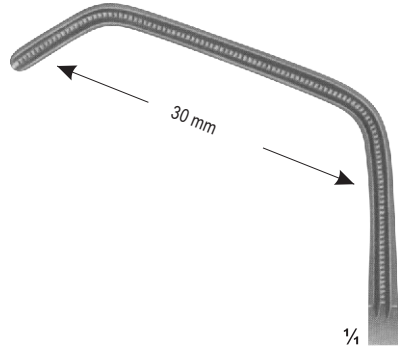

1/4

JJ-16-223
80 mm

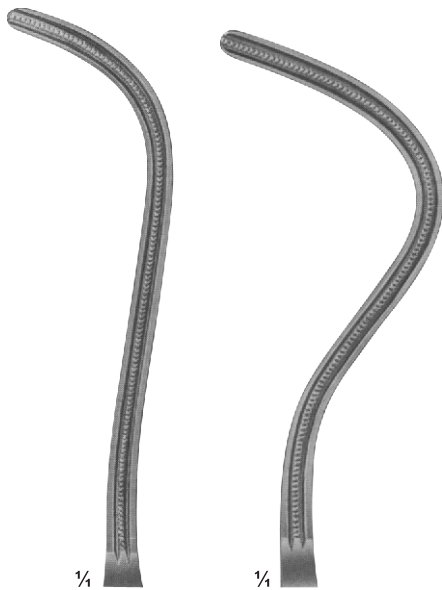

1/4

JJ-16-224
86 mm

1/4

JJ-16-225
86 mm

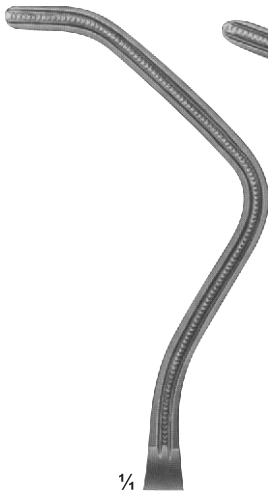

1/4

JJ-16-226
86 mm

1/4

JJ-16-227
86 mm



1/2

DE BAKEY-HARKEN
JJ-16-224 25.5 cm
JJ-16-225 24.5 cm
JJ-16-226 24.5 cm
JJ-16-227 24.5 cm

MULTI-PURPOSE CLAMPS

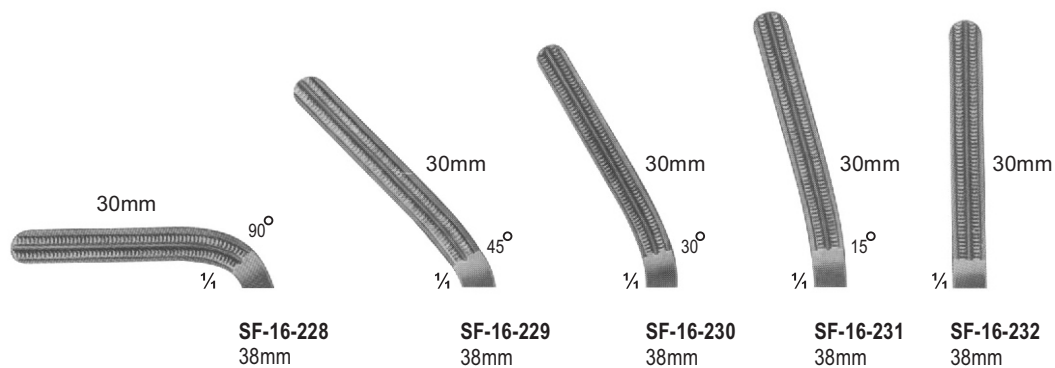

DARDIK

JJ-16-228 15 cm
JJ-16-229 15 cm
JJ-16-230 15 cm
JJ-16-231 14.5 cm
JJ-16-232 13 cm

JJ-16-233 17 cm
JJ-16-234 17 cm
JJ-16-235 17 cm
JJ-16-236 16 cm
JJ-16-237 13.5 cm

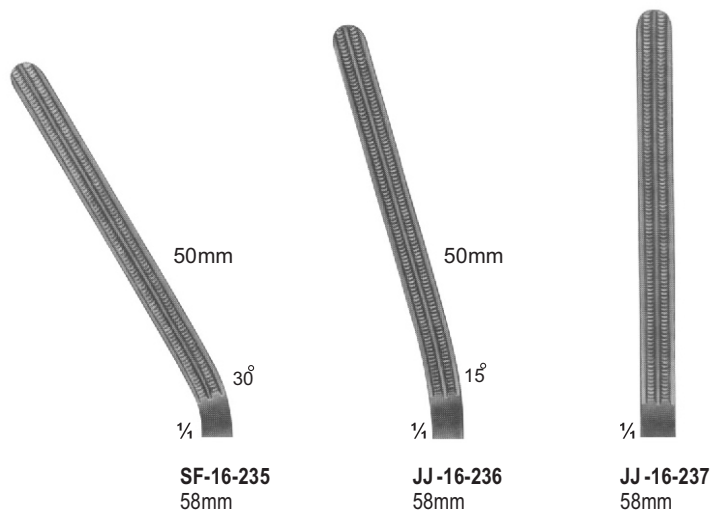
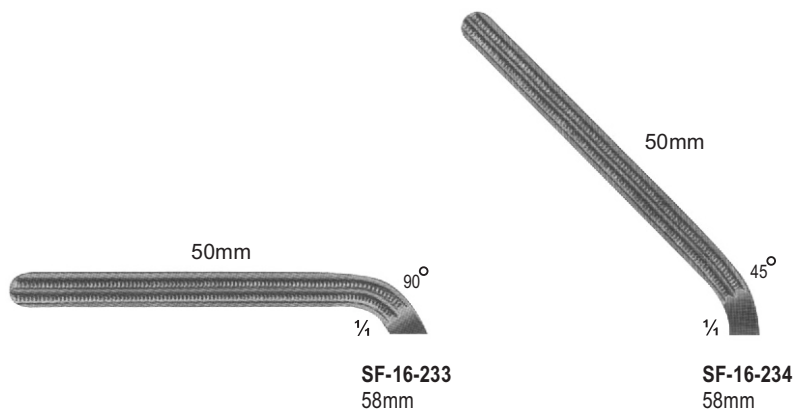

ATRAUMA

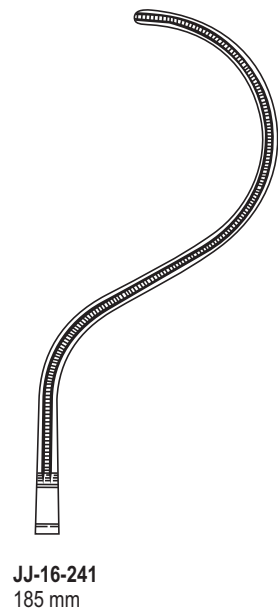
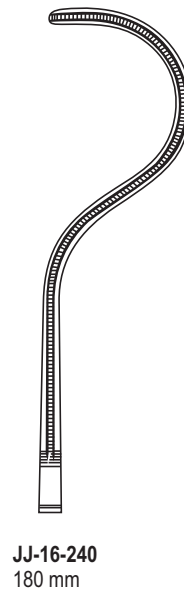
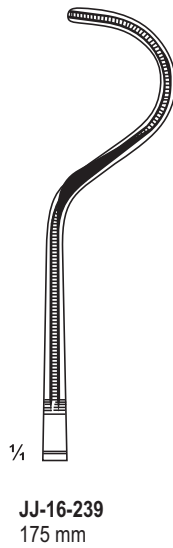
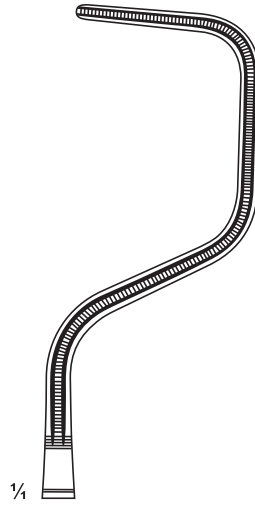
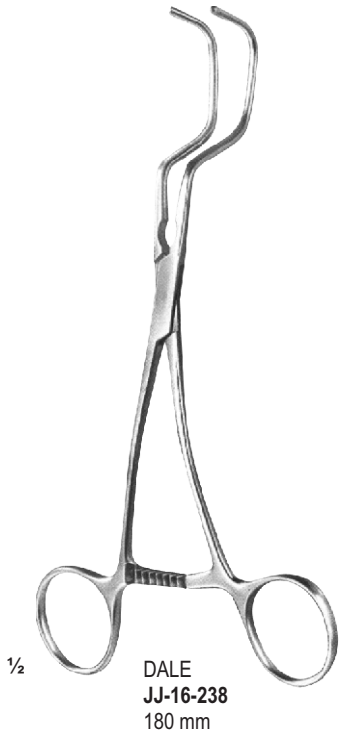

ATRAUMA

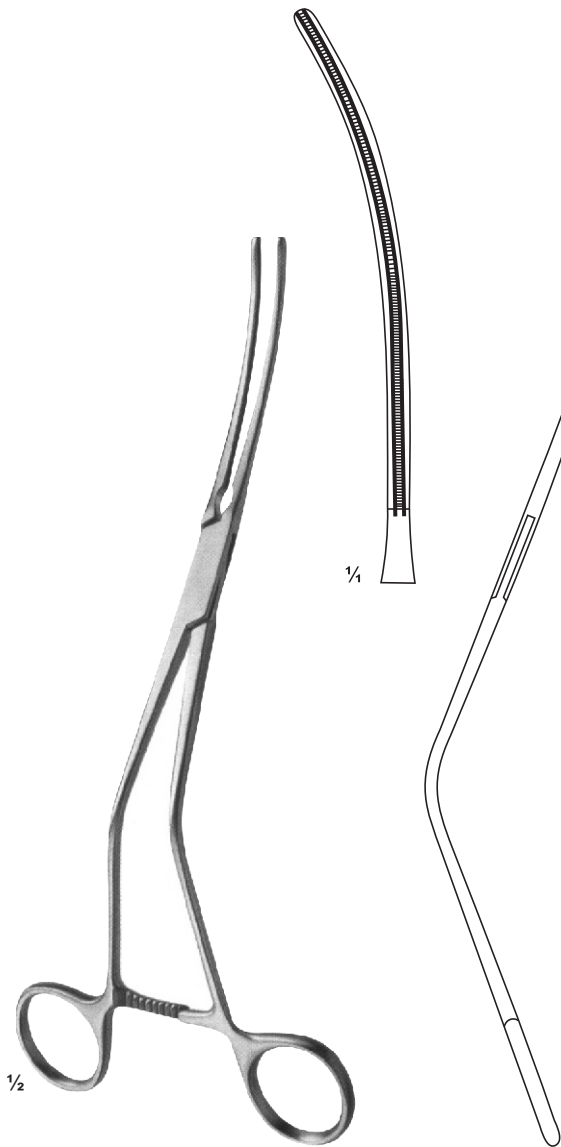

WYLIE
JJ-16-242
240 mm

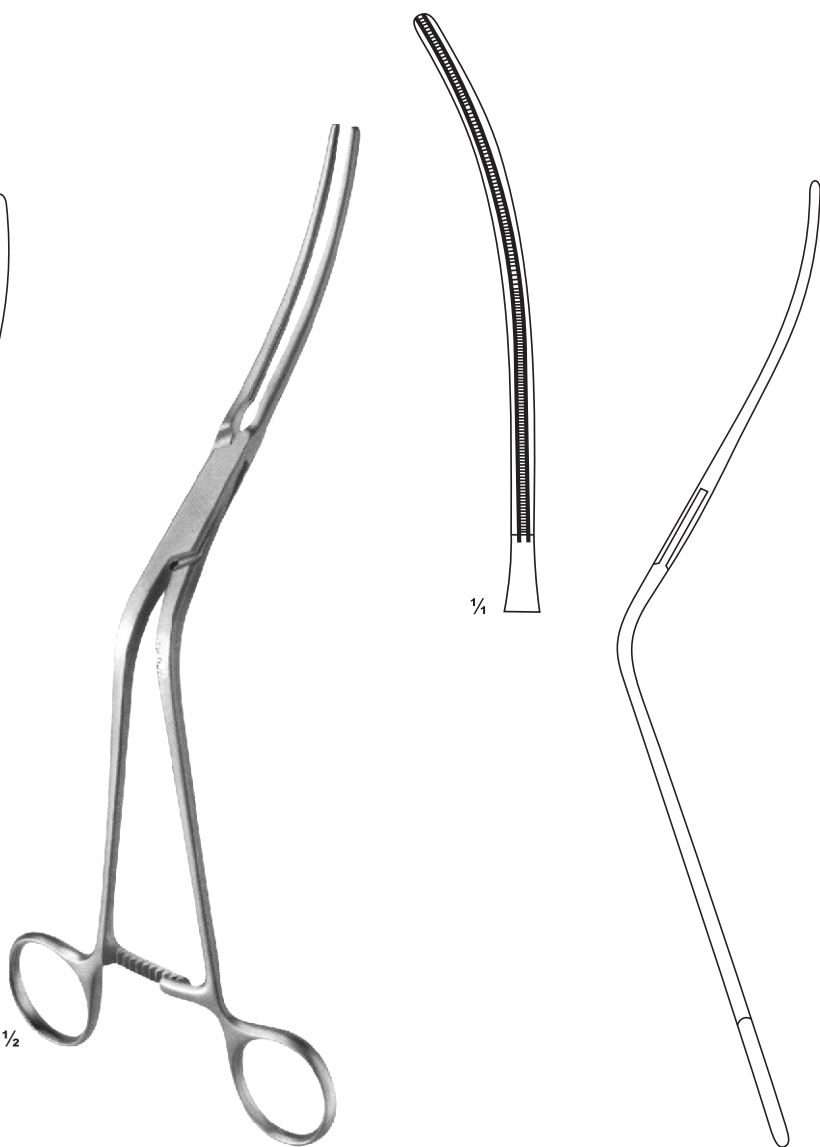

WYLIE
JJ-16-243
270 mm

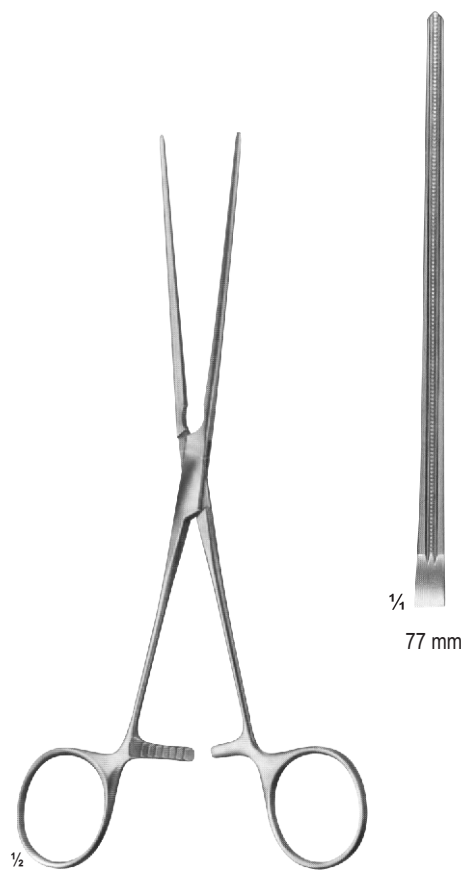

1/2
LELAND-JONES
JJ-16-244
195 mm

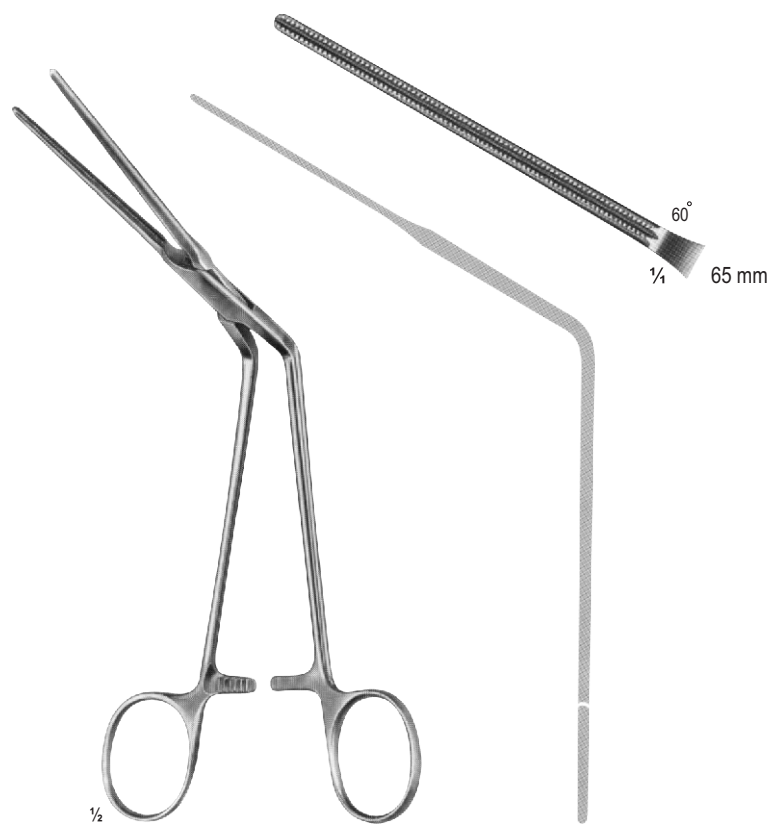

1/2
DE BAKEY
JJ-16-245
200 mm
Lliac Clamp



1/2
COOLEY
JJ-16-246 120 mm
JJ-16-247 125 mm
JJ-16-248 125 mm

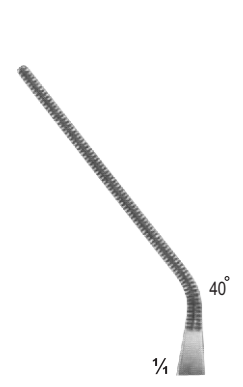

1/4
JJ-16-246
50 mm



1/4
JJ-16-247
50 mm



1/4
JJ-16-248
52 mm

ANEURYSM CLAMPS

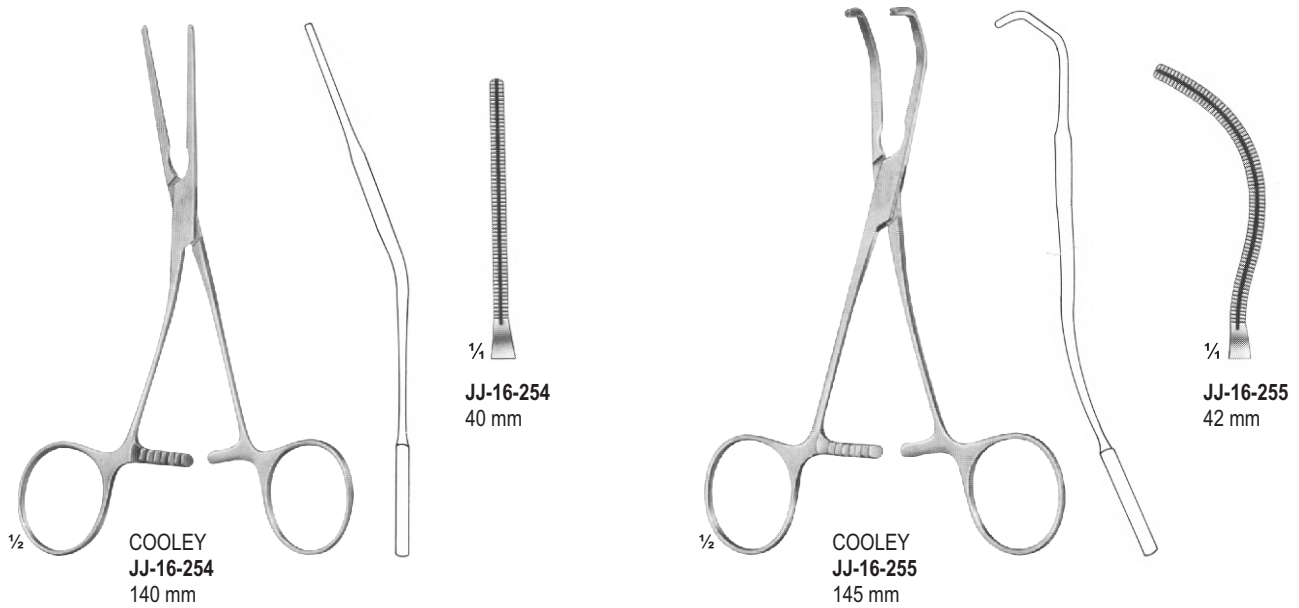
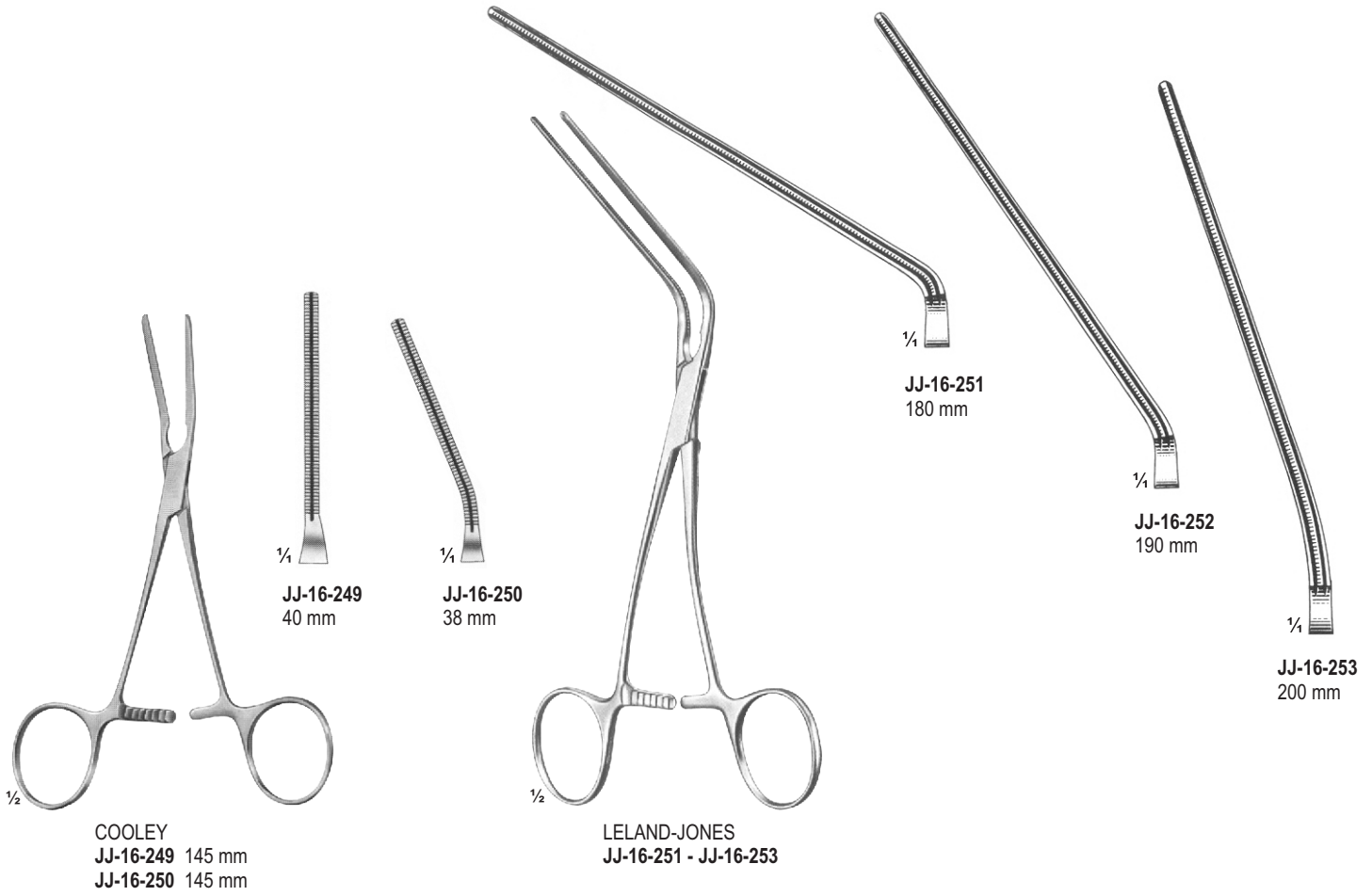

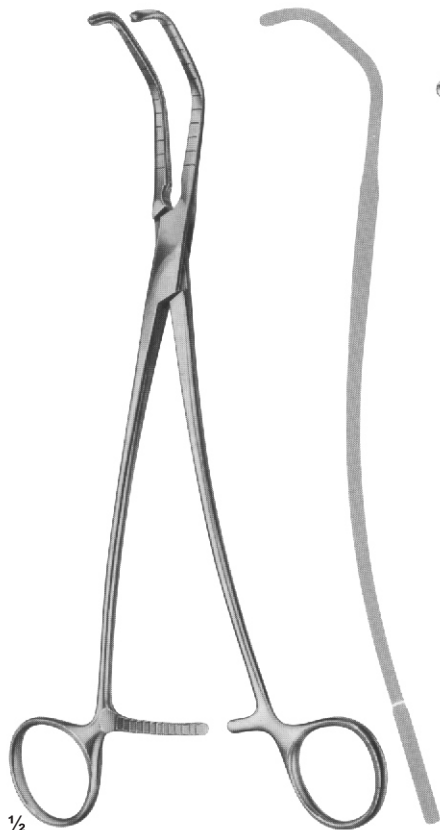

$\frac{1}{2}$
JJ-16-256 - JJ-16-258
DE BAKEY-SATINSKY
235 mm, 240 mm, 245 mm

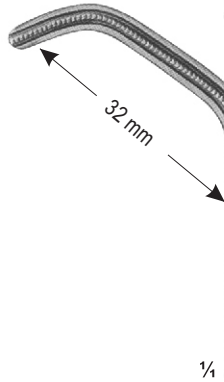

$\frac{1}{4}$
JJ-16-256
68 mm

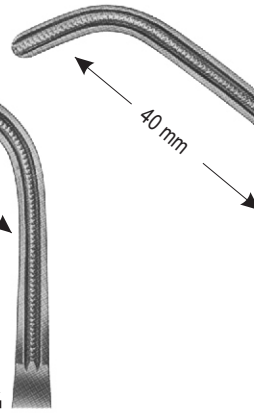

$\frac{1}{4}$
JJ-16-257
76 mm

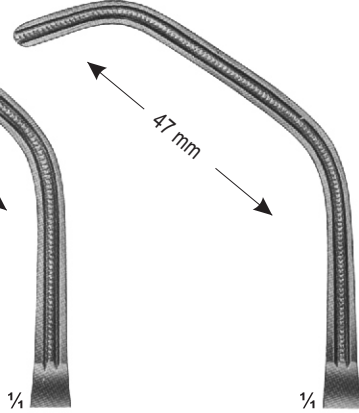

$\frac{1}{4}$
JJ-16-258
84 mm

VASCULAR CLAMPS

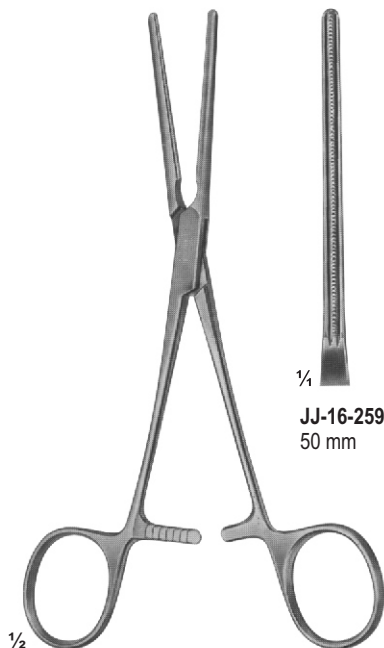

$\frac{1}{2}$
JJ-16-259 - JJ-16-260
DE BAKEY
170 mm, 165 mm



$\frac{1}{4}$
JJ-16-259
50 mm



$\frac{1}{4}$
JJ-16-260
50 mm



$\frac{1}{2}$
JJ-16-261
DE BAKEY
165 mm

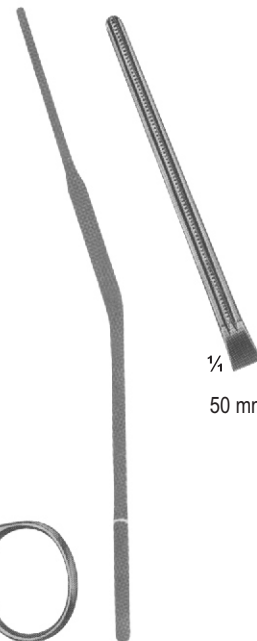

$\frac{1}{4}$
50 mm

VENA-CAVA CLAMPS



JJ-16-262 - JJ-16-264
DE BAKEY
205 mm, 225 mm, 240 mm

JJ-16-262 41 mm
JJ-16-263 65 mm
JJ-16-264 80 mm

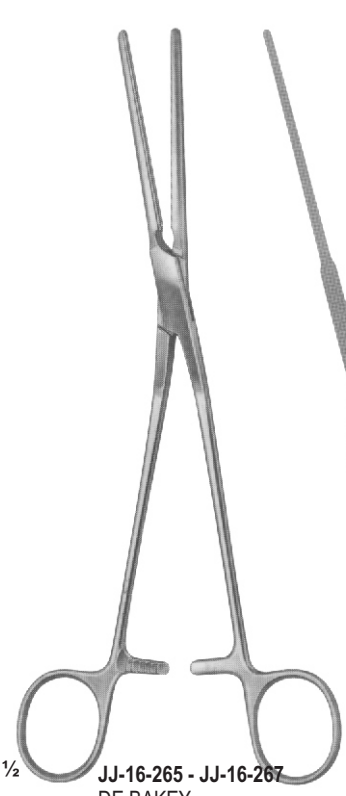

JJ-16-265 - JJ-16-267
DE BAKEY
200 mm, 225 mm, 240 mm

JJ-16-265 41 mm
JJ-16-266 65 mm
JJ-16-267 80 mm

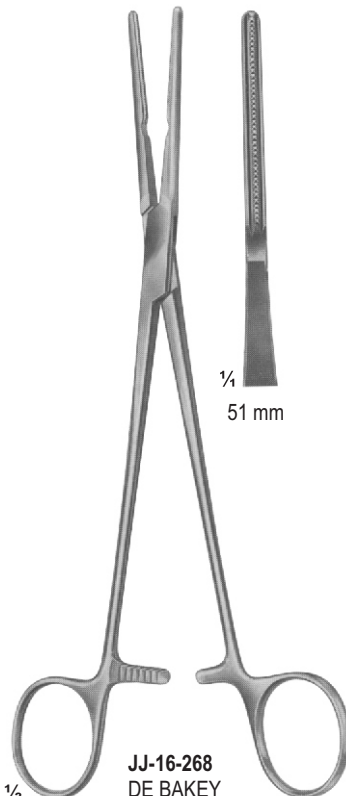

JJ-16-268
DE BAKEY
210 mm

1/4
51 mm



JJ-16-269
DE BAKEY
210 mm

15°
1/4
51 mm



JJ-16-270
DE BAKEY
160 mm

1/4
56 mm

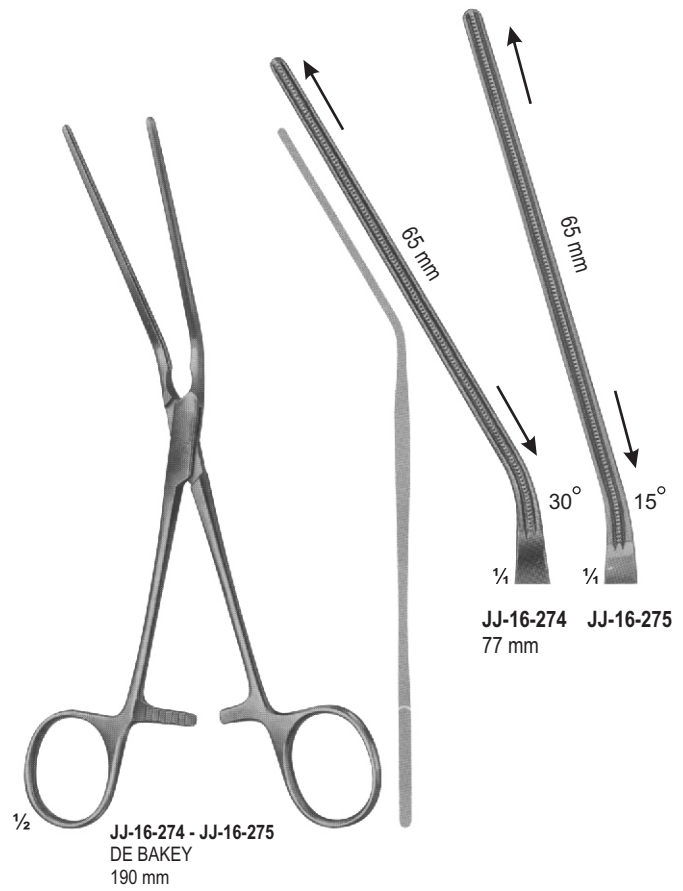
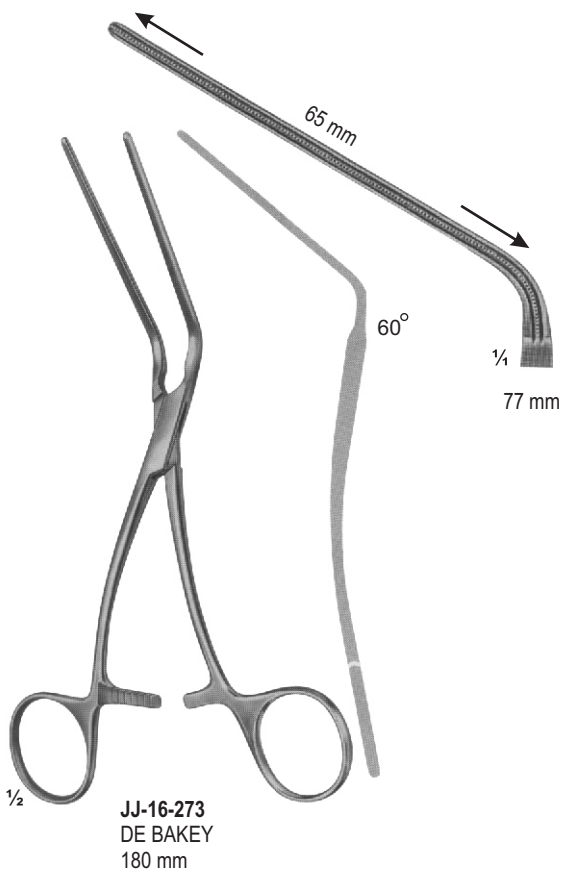
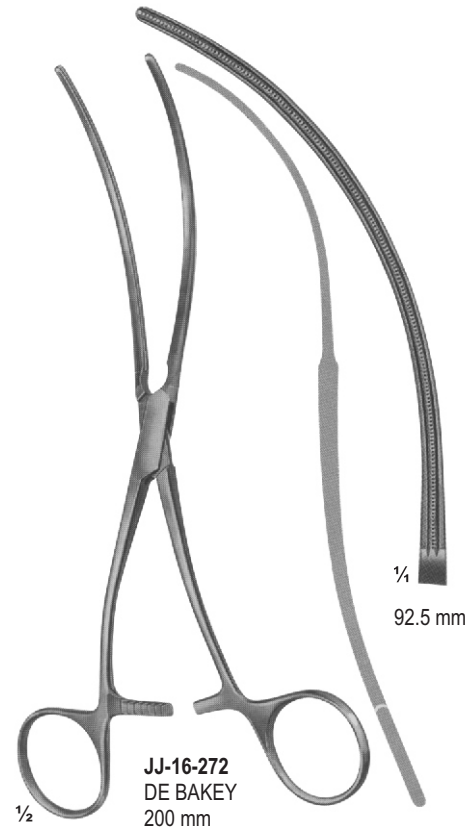
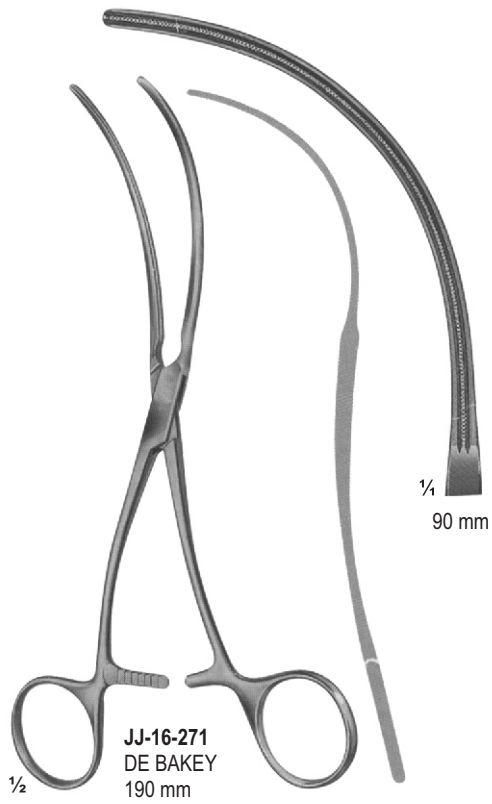

VENA-CAVA CLAMPS

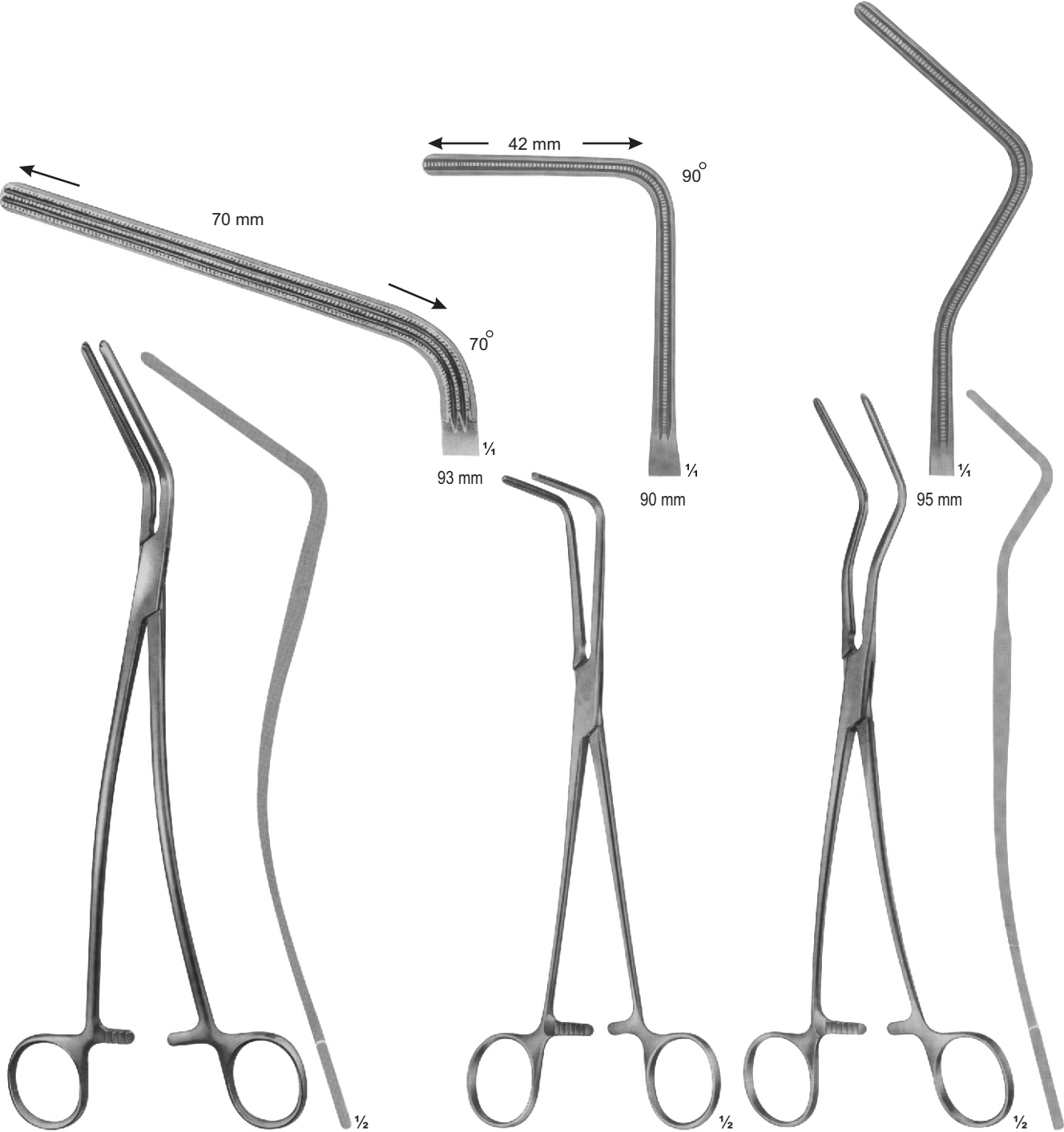

JJ-16-276
DE BAKEY
240 mm

JJ-16-277
LEES
220 mm

JJ-16-278
LEES
245 mm

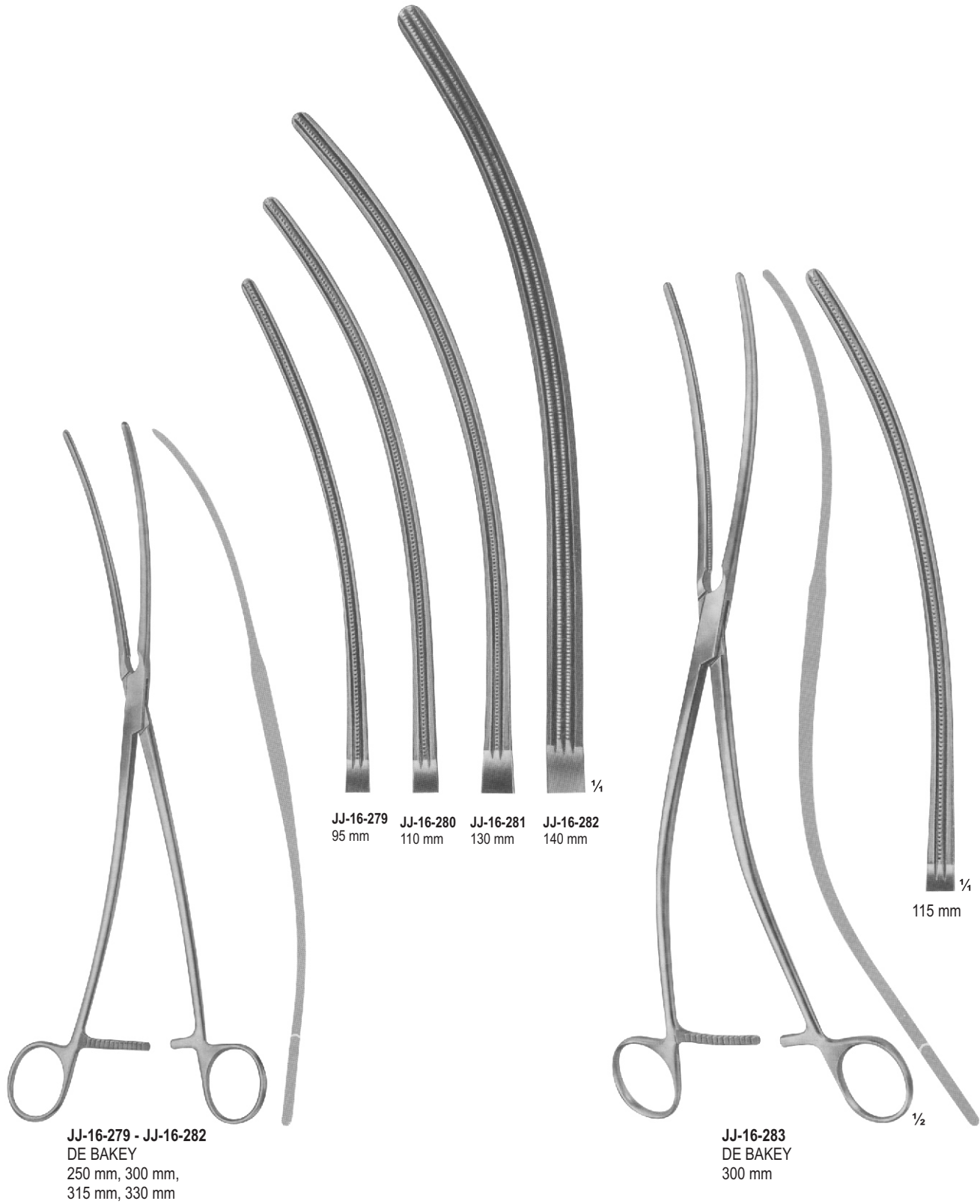

AORTA CLAMPS

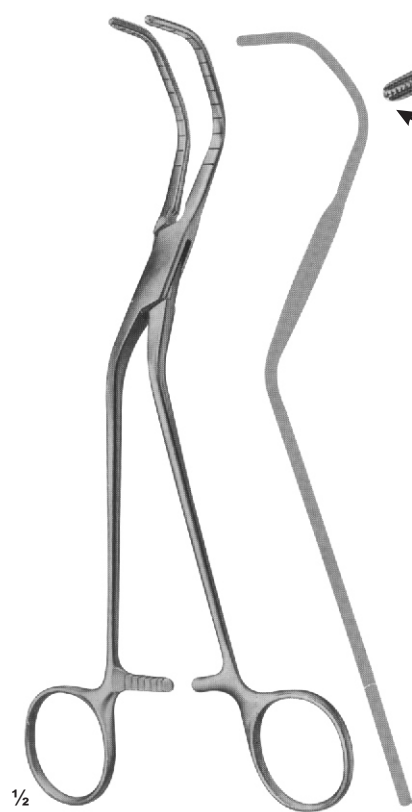

JJ-16-284
DIETRICH
210 mm

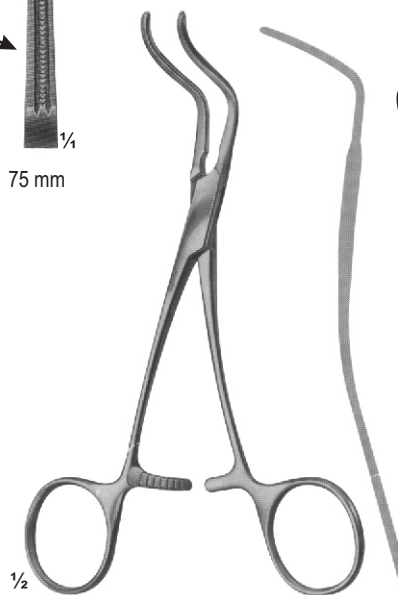
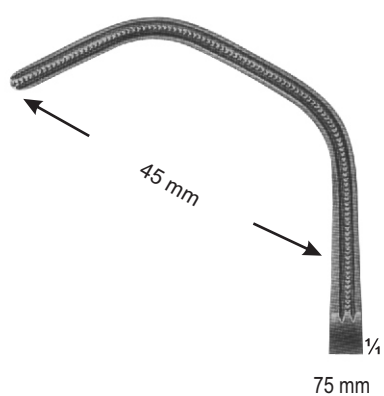

JJ-16-285
SUBRAMANIAN
155 mm

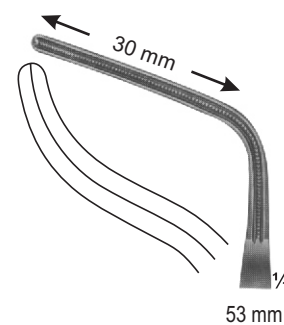

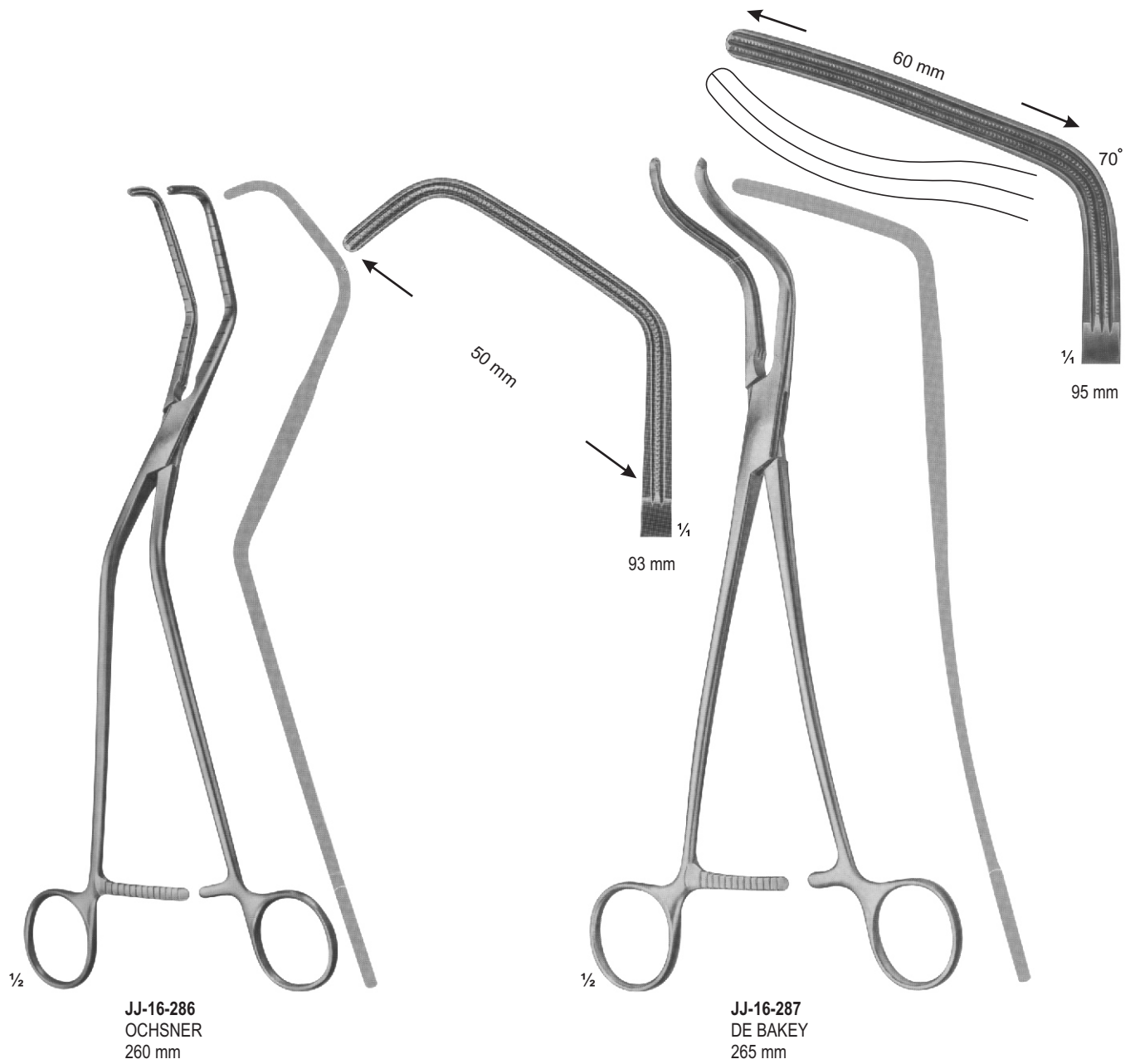

AORTA-ANASTOMOSIS CLAMPS

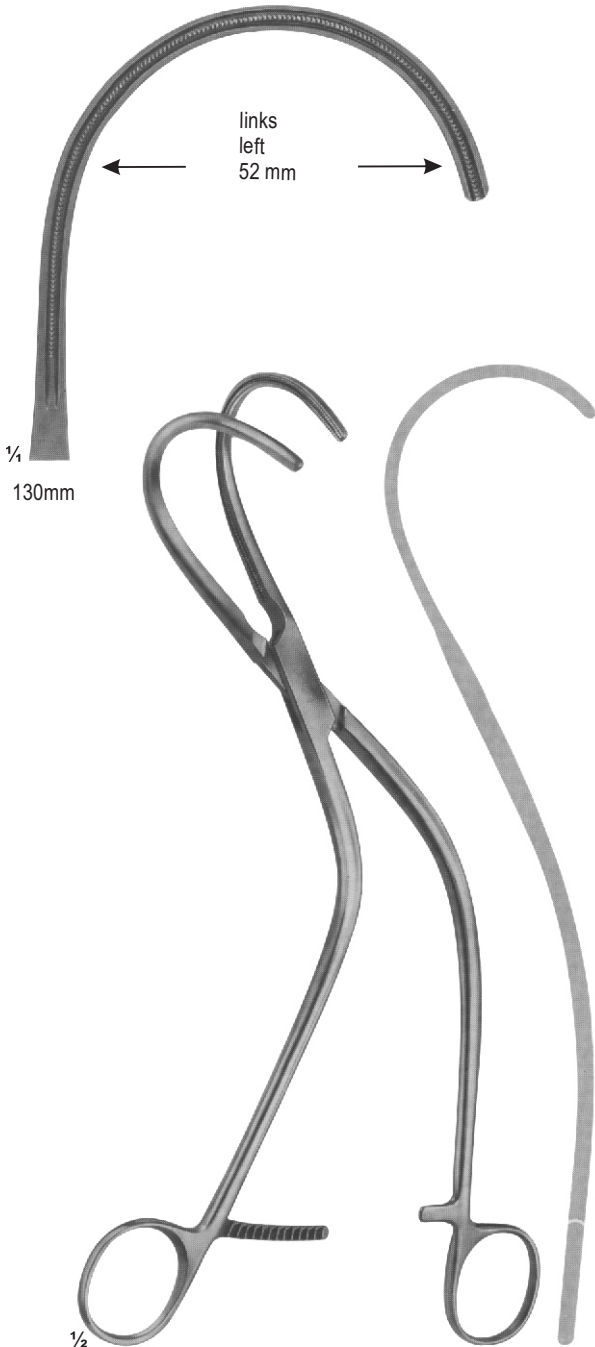

JJ-16-288
WEBER
265 mm

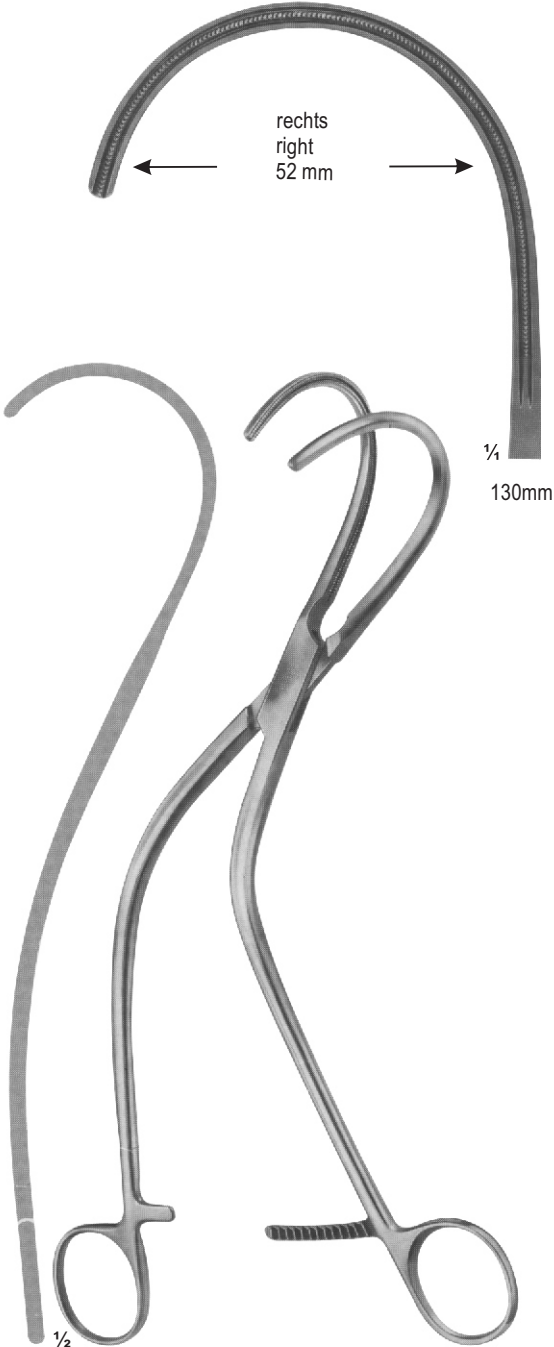

JJ-16-289
WEBER
265 mm

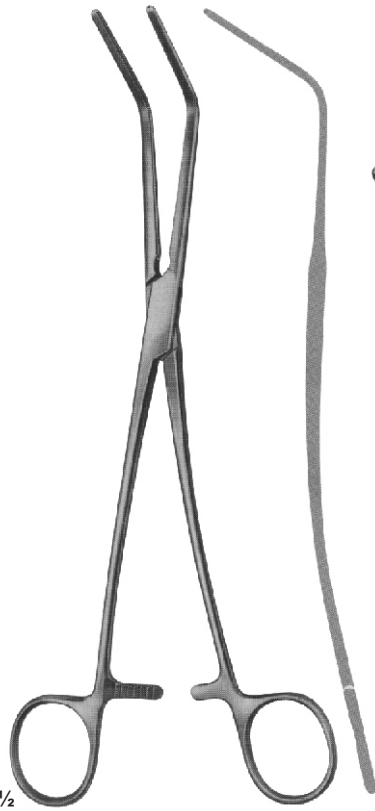

1/2

JJ-16-290 - JJ-16-293
DE BAKEY

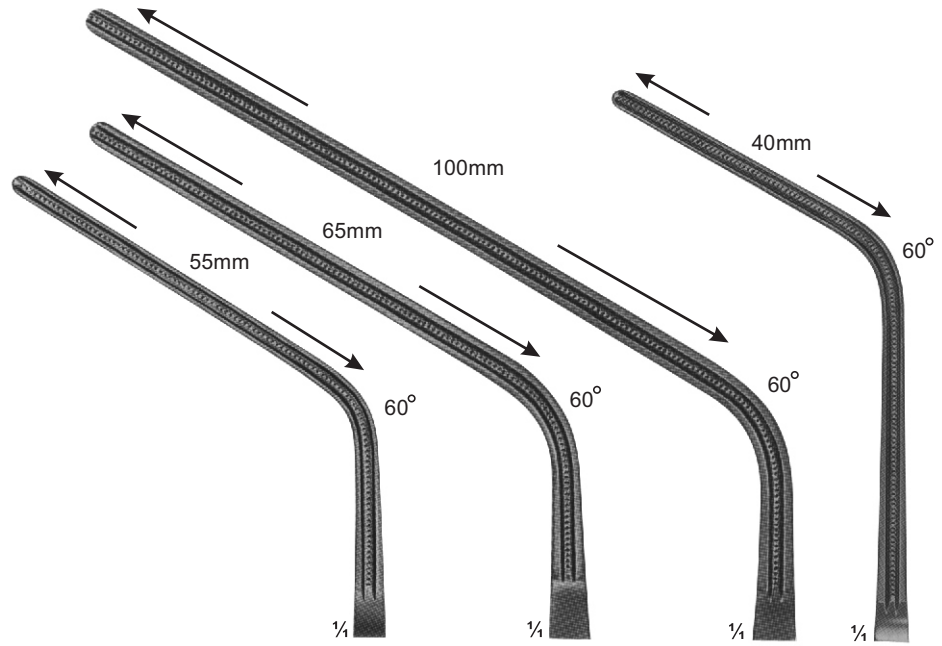

JJ-16-290

JJ-16-291

JJ-16-292

JJ-16-293

Total Length: 230 mm

280 mm

305 mm

240 mm

Length of jaws: 85 mm

100 mm

135 mm

93 mm



1/2

JJ-16-294 - JJ-16-297
DE BAKEY

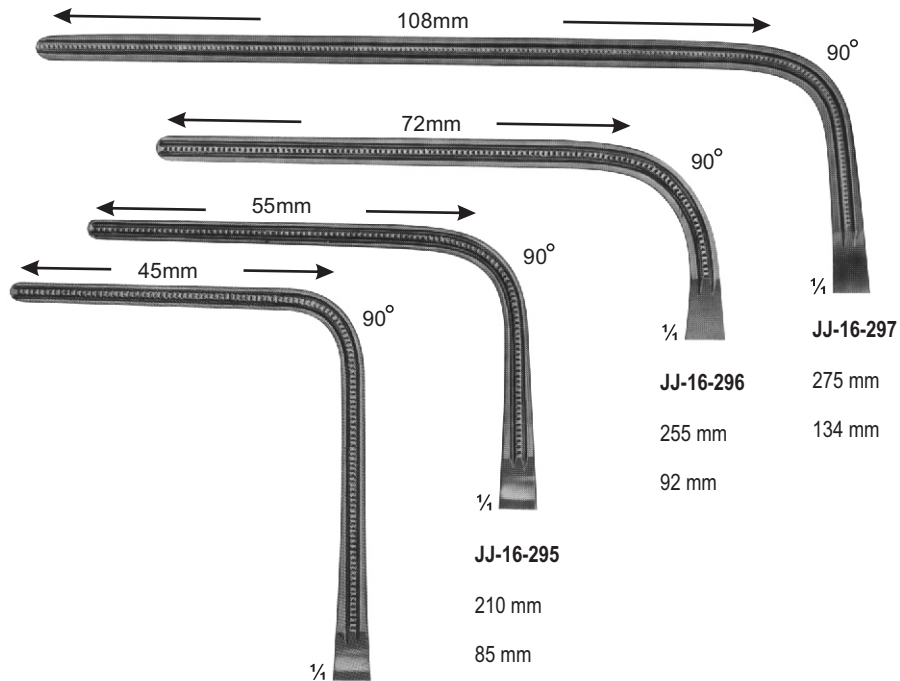

JJ-16-294

JJ-16-295

JJ-16-296

JJ-16-297

Total Length: 225 mm

210 mm

255 mm

134 mm

Length of jaws: 93 mm

85 mm

92 mm

RING HANDLE BULLDOG CLAMPS

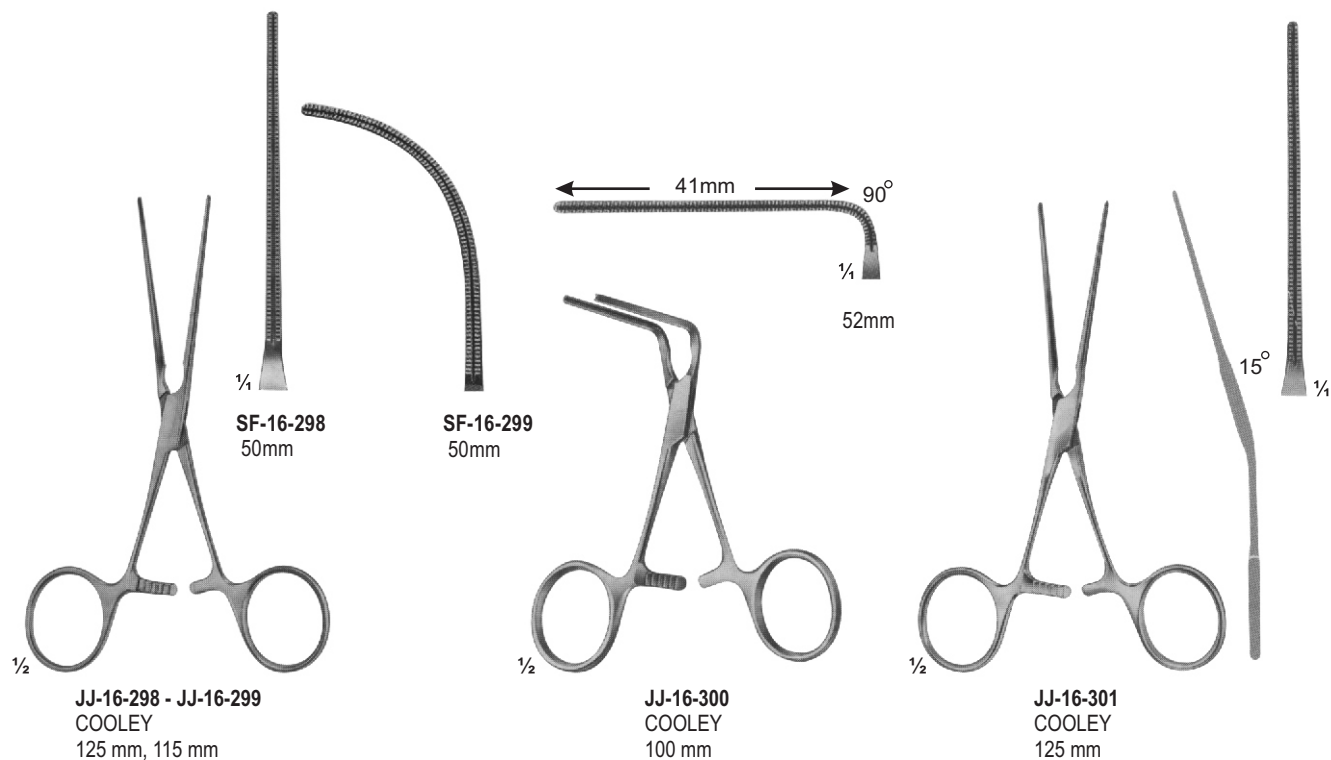

ANASTOMOSIS CLAMPS, PEDIATRIC PATTERNS

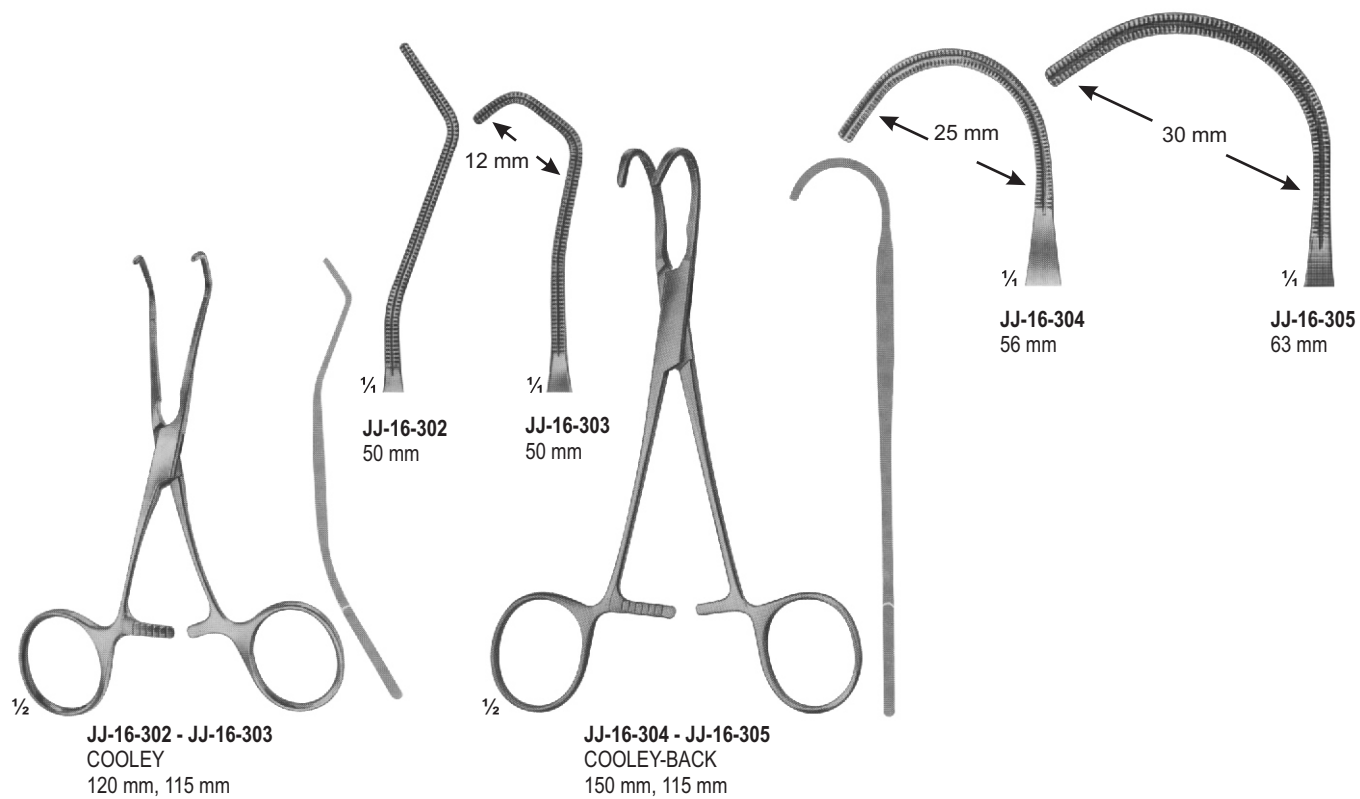

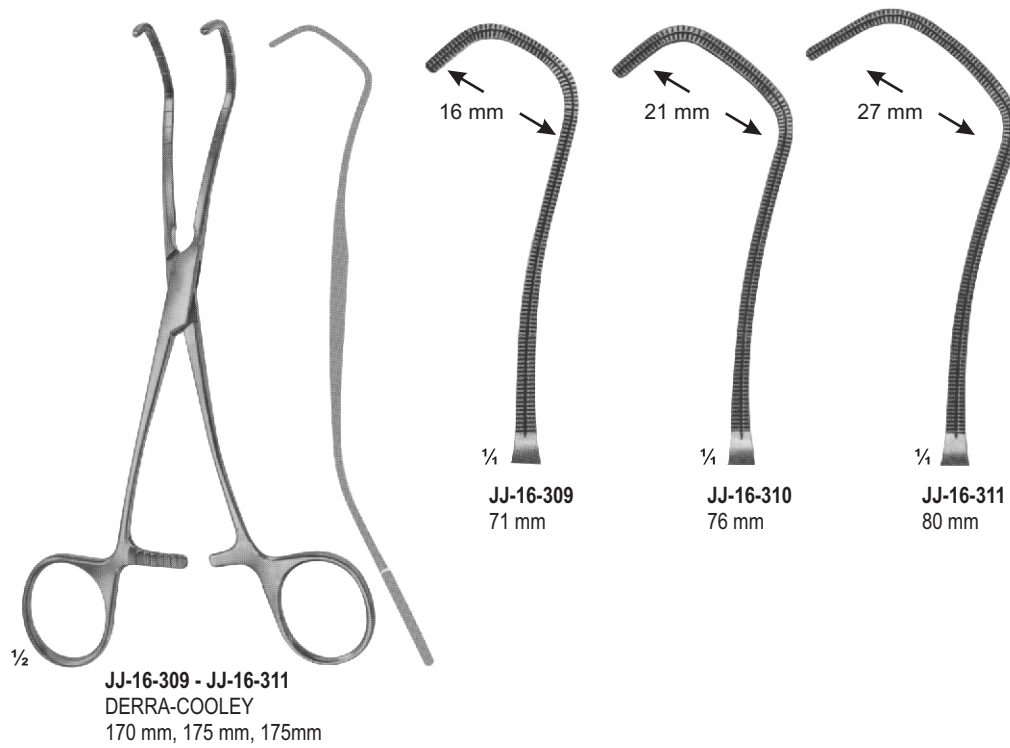
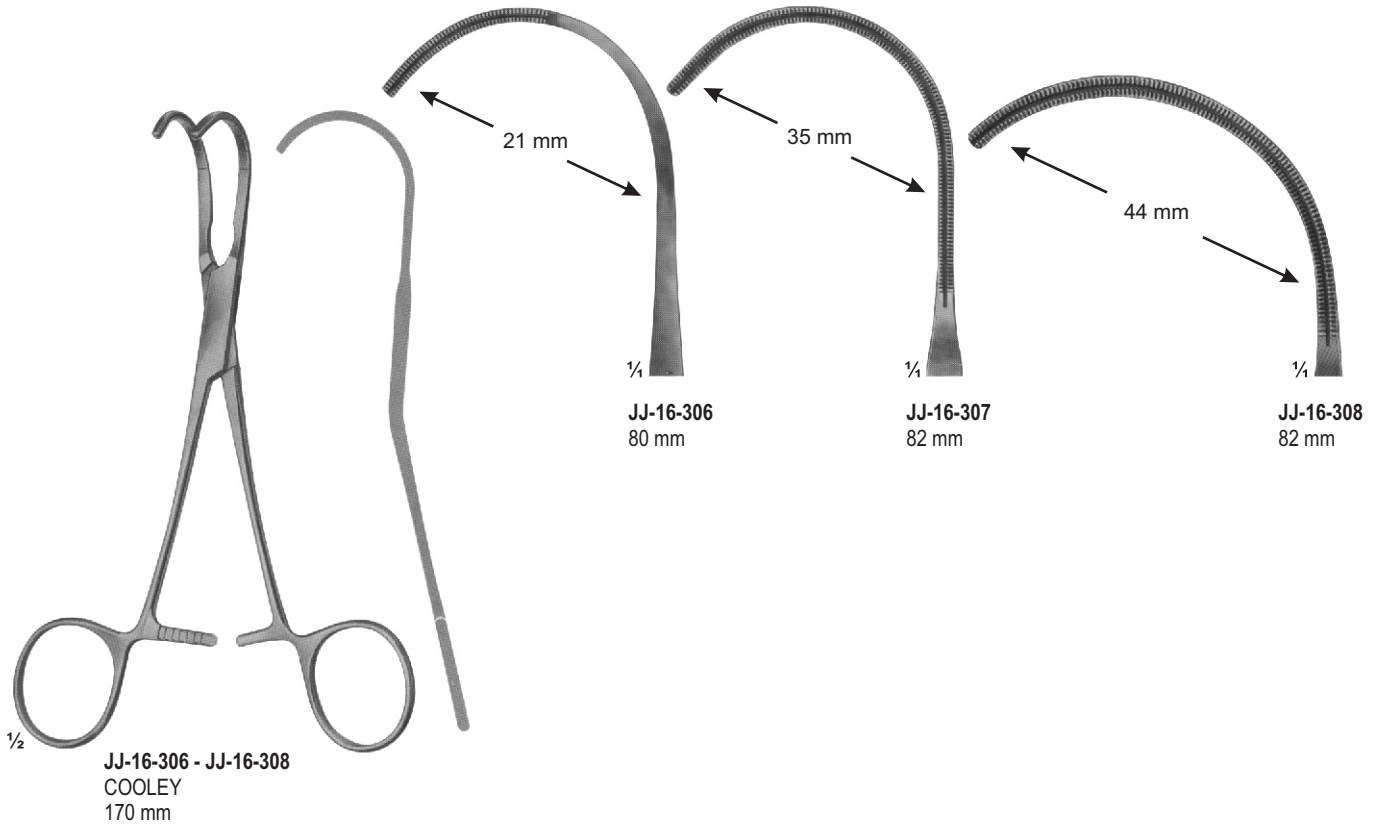

AORTA-ANASTOMOSIS CLAMPS

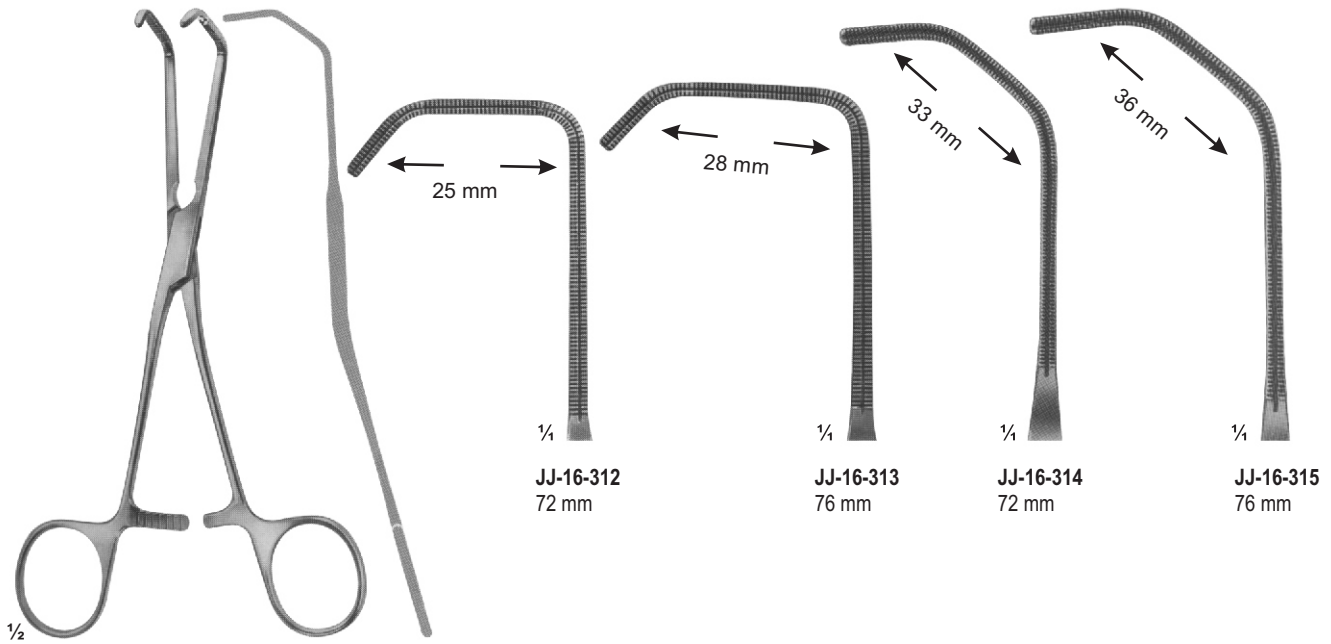

JJ-16-312 - JJ-16-315
COOLEY
 165 mm, 165 mm
 175 mm, 180 mm

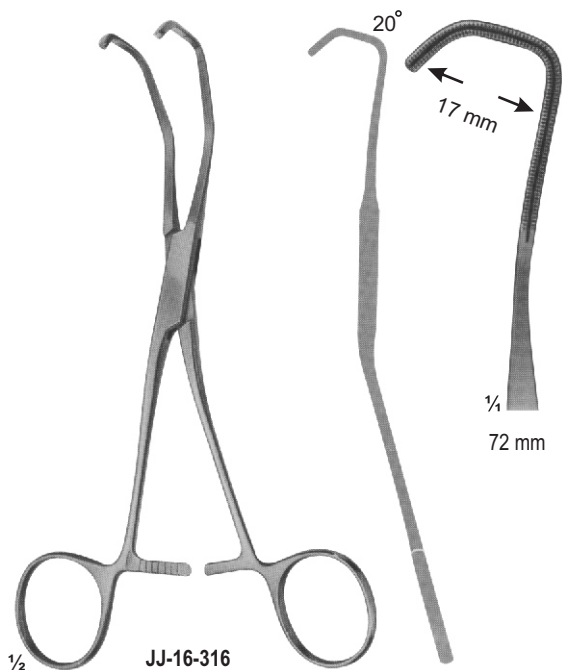

JJ-16-316
COOLEY
 170 mm

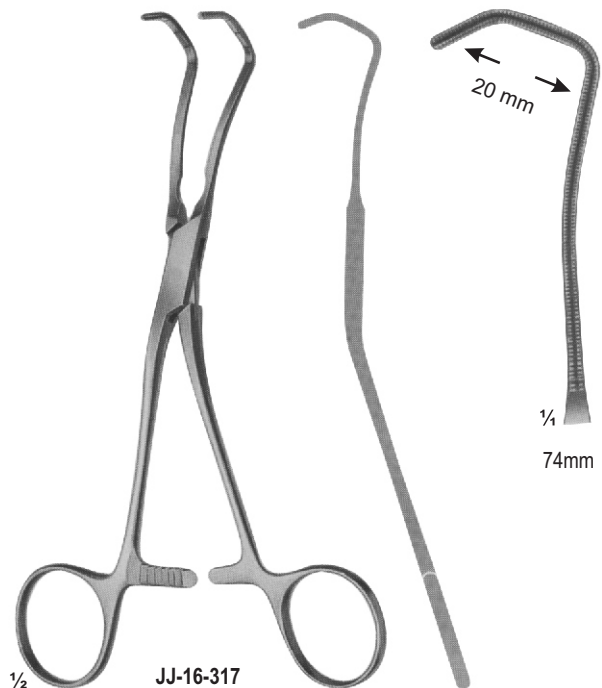

JJ-16-317
COOLEY
 175 mm

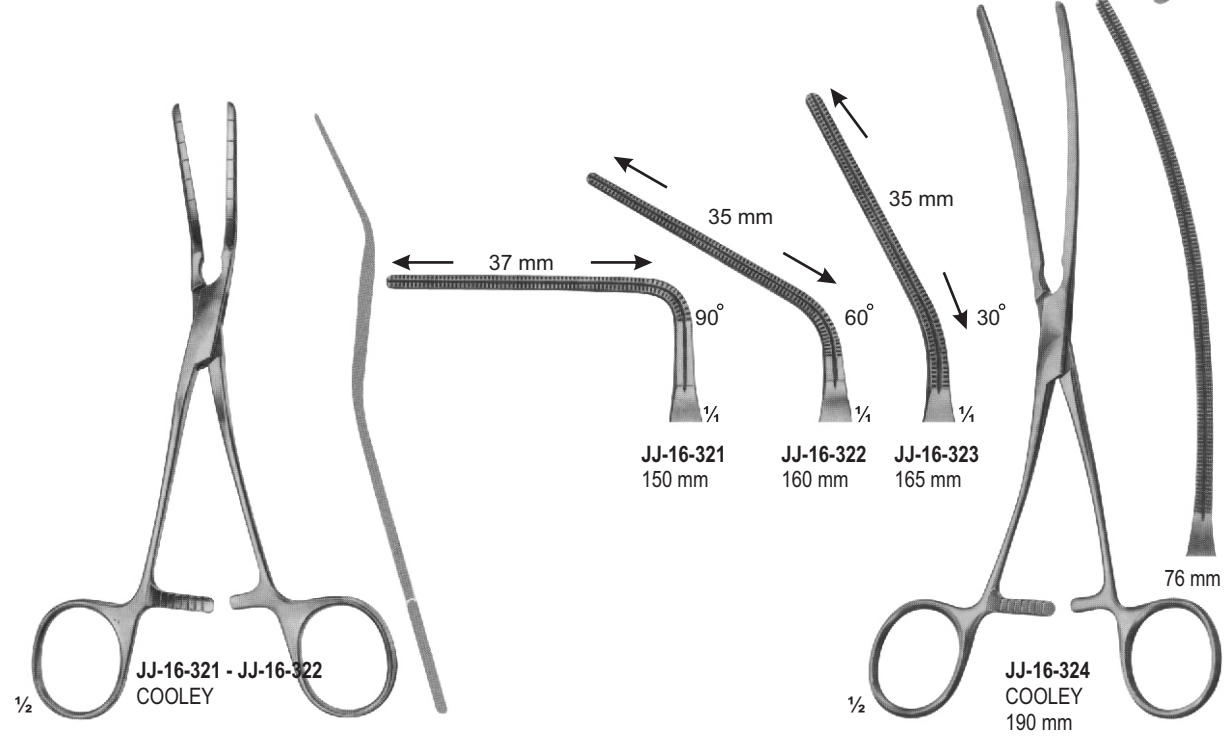
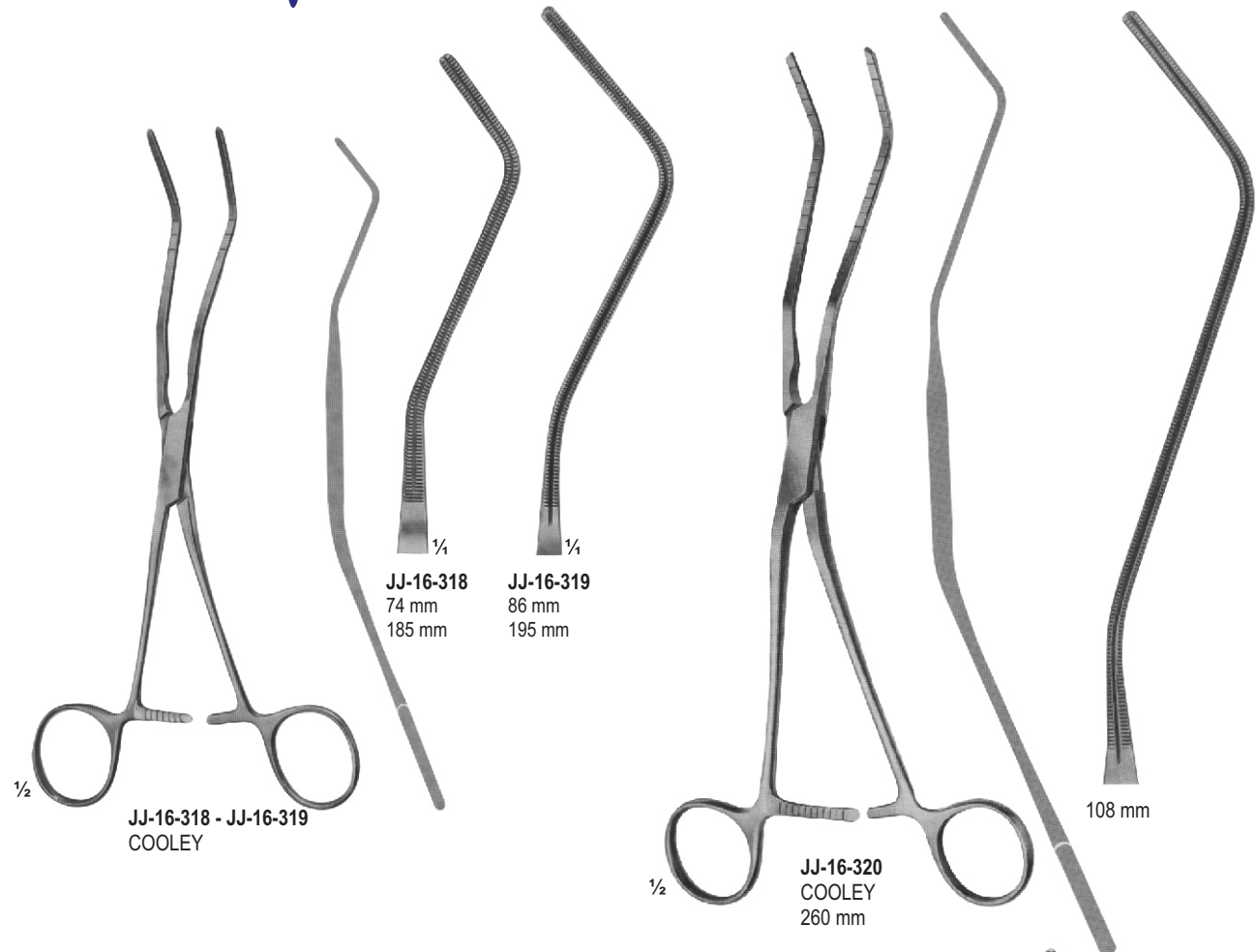

AORTA-ANASTOMOSIS CLAMPS

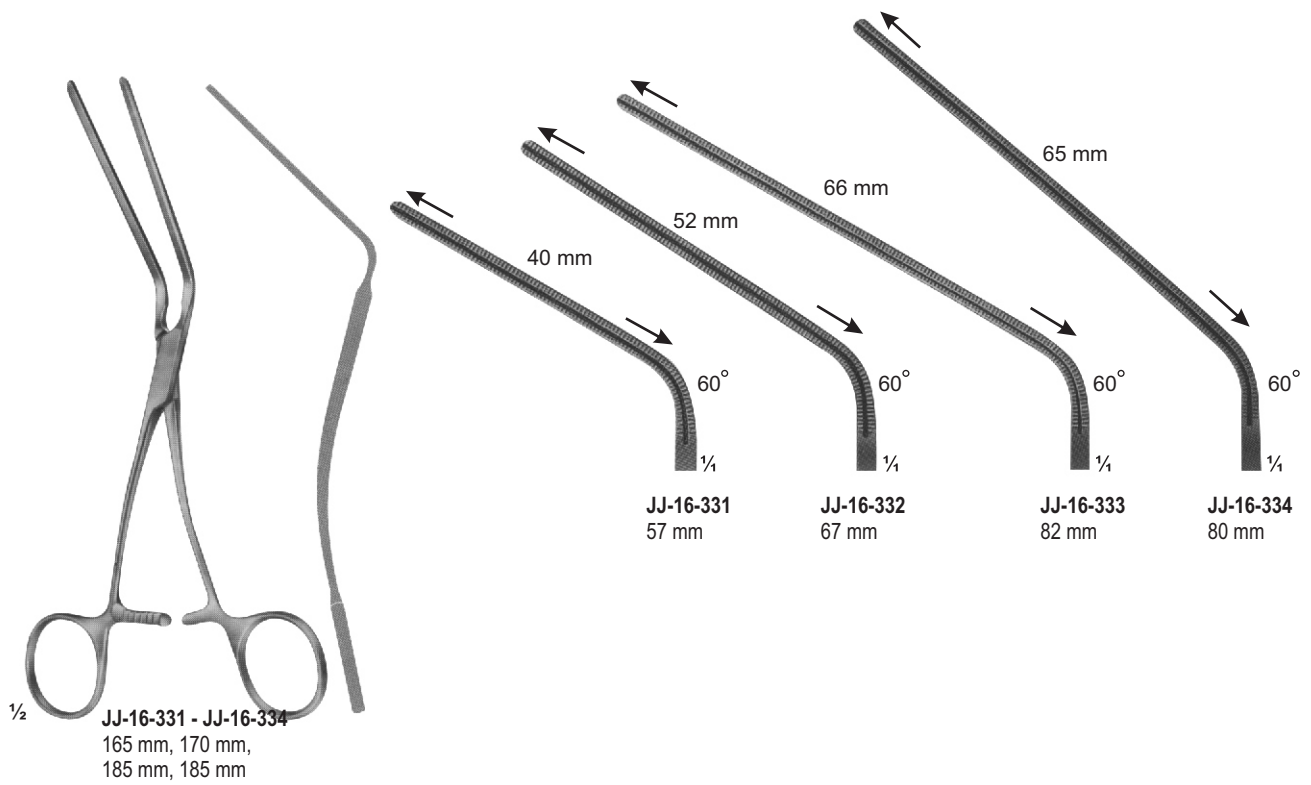
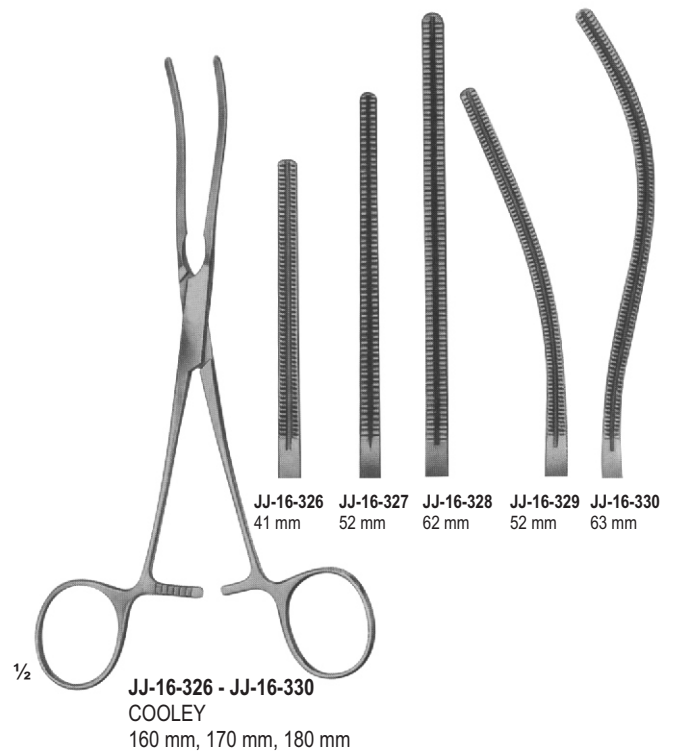
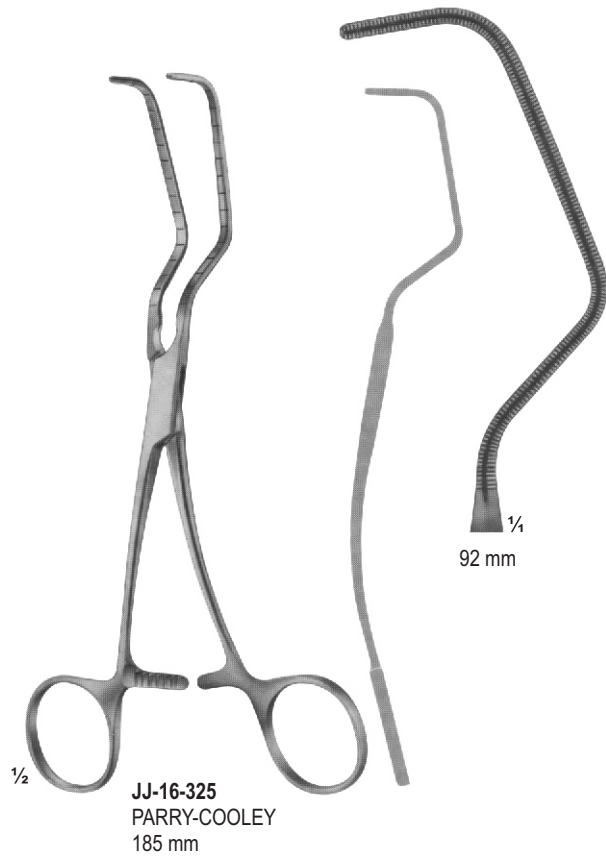



1/2 DARDIK
JJ-16-335 150 mm
JJ-16-336 150 mm
JJ-16-337 150 mm
JJ-16-338 145 mm
JJ-16-339 130 mm

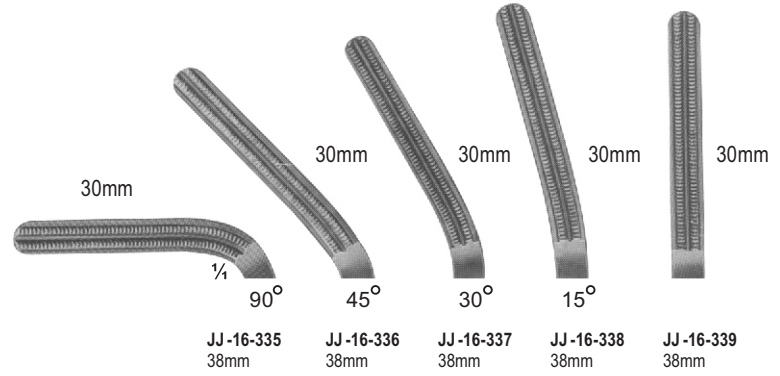

1/2 DARDIK
JJ-16-335 170 mm
JJ-16-336 170 mm
JJ-16-337 170 mm
JJ-16-338 160 mm
JJ-16-339 135 mm

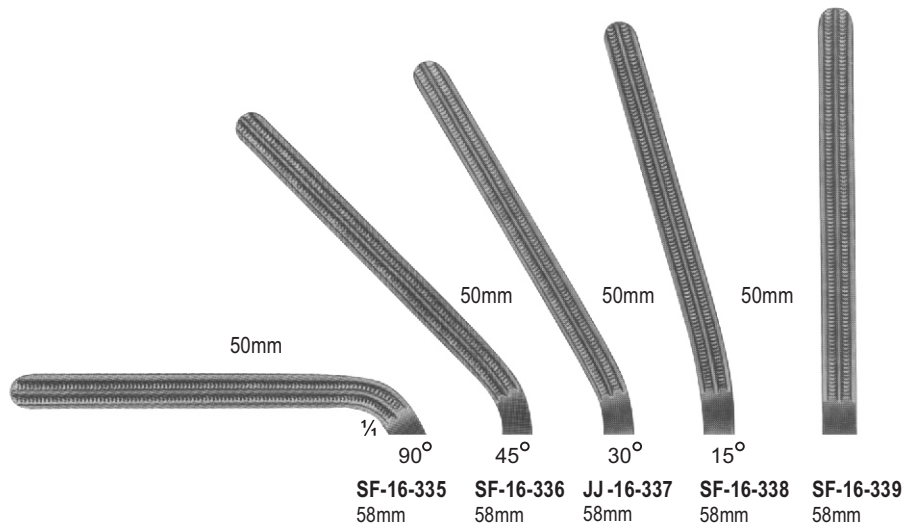

MULTI-PURPOSE CLAMPS

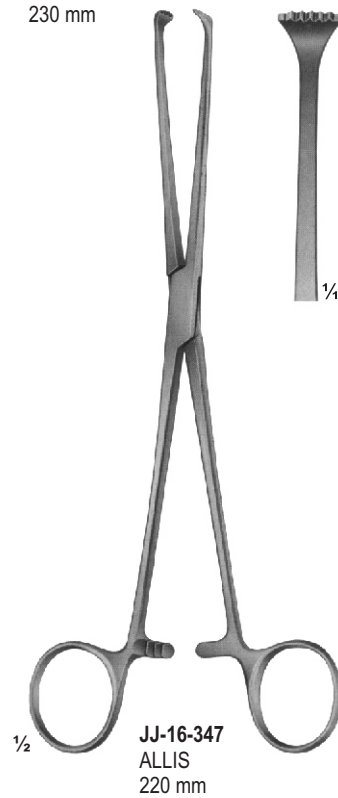
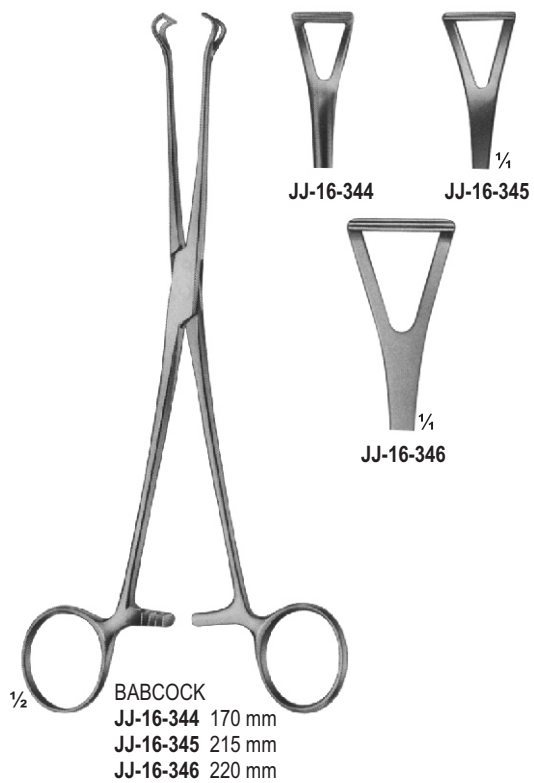
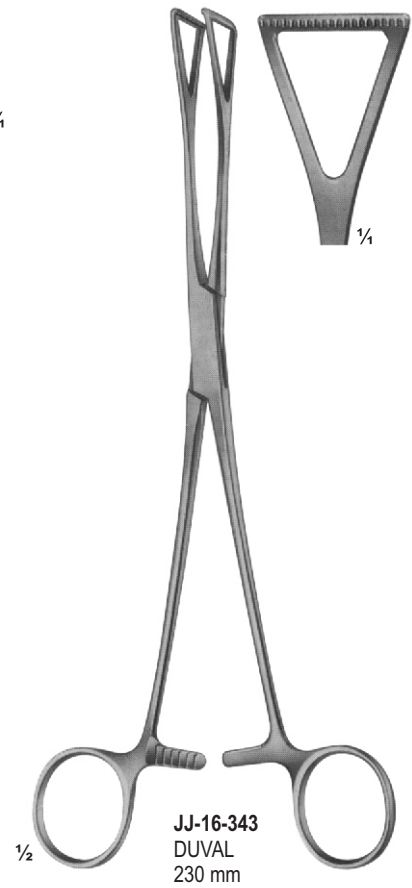
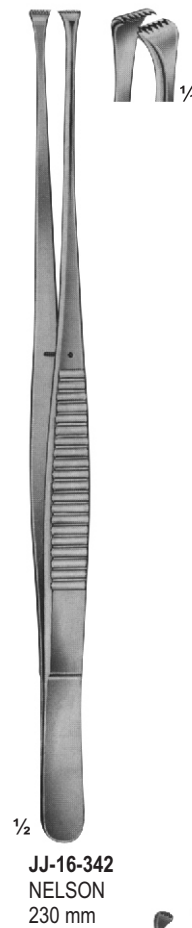

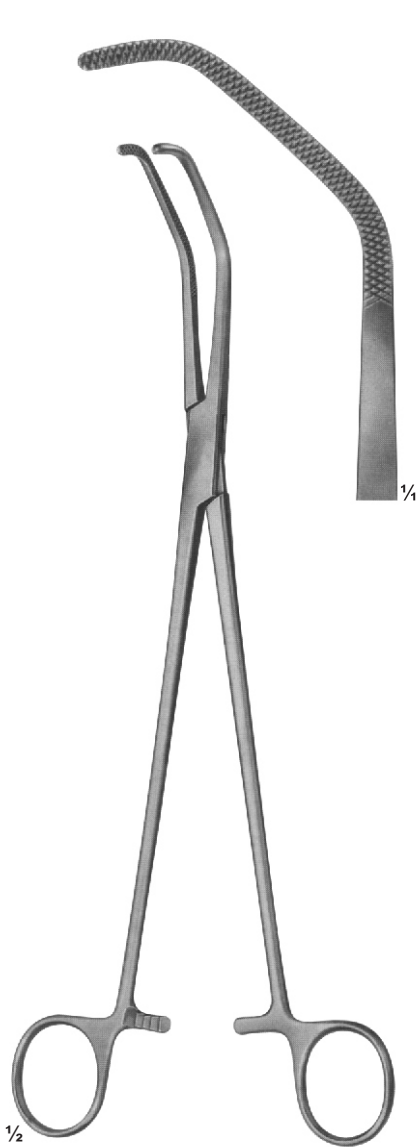

JJ-16-348
SATINSKY
265 mm



JJ-16-349
SATINSKY
265 mm

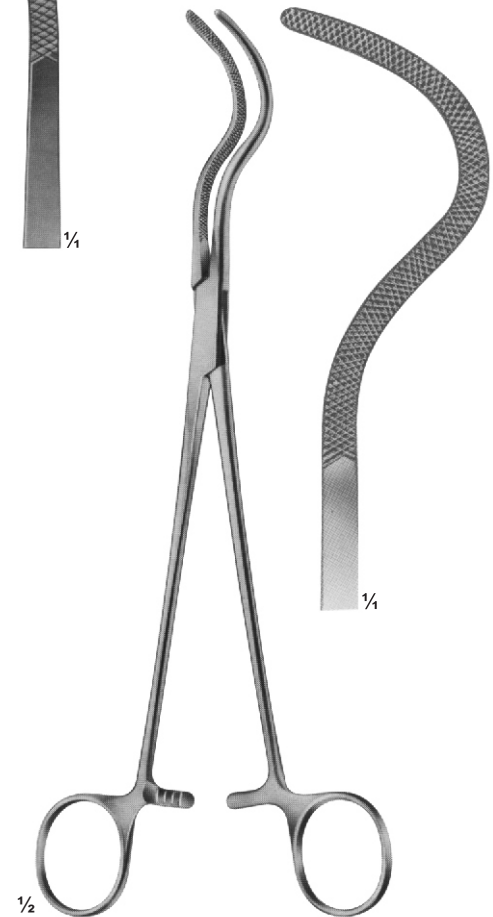

JJ-16-350
HARKEN
240 mm

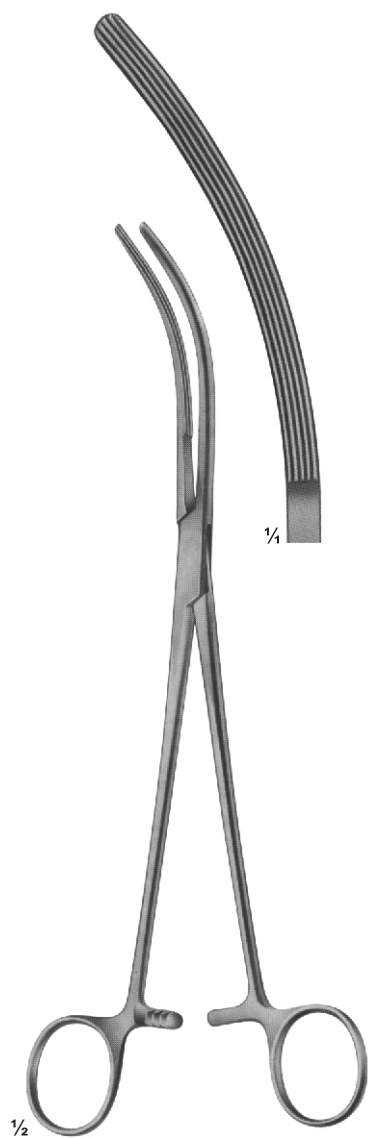

JJ-16-351
CRAFOORD-SELLORS
240 mm

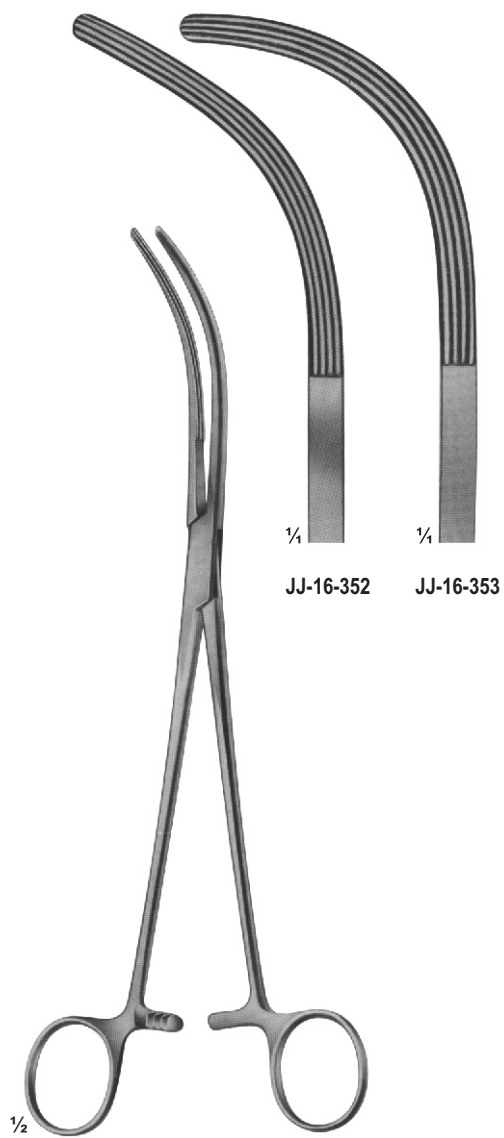

JJ-16-352 - JJ-16-353
CRAFOORD
240 mm



$\frac{1}{2}$
JJ-16-354
PRICE THOMAS
225 mm



$\frac{1}{2}$
JJ-16-355 - JJ-16-356
PRICE THOMAS
225 mm

$\frac{1}{4}$
JJ-16-355
jaws with pins

$\frac{1}{4}$
JJ-16-356
jaws with pins

FORCEPS

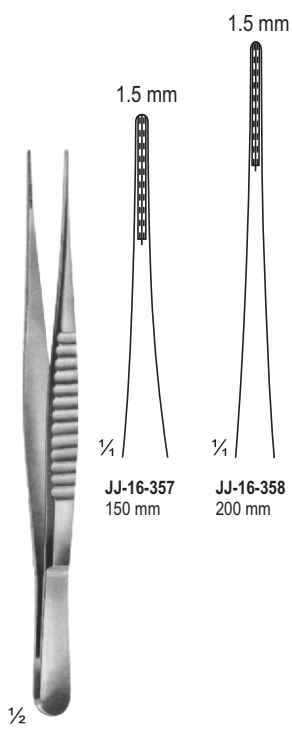

1/2
JJ-16-357 - JJ-16-358
 DE BAKEY

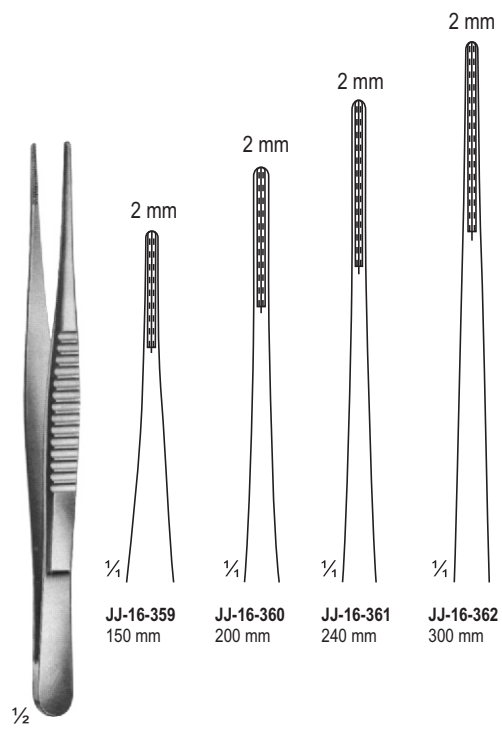

1/2
JJ-16-359 - JJ-16-362
 DE BAKEY

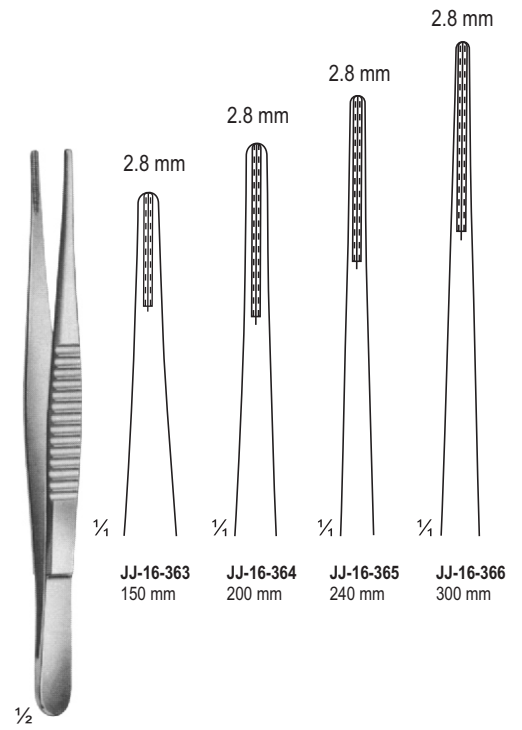

1/2
JJ-16-363 - JJ-16-366
 DE BAKEY

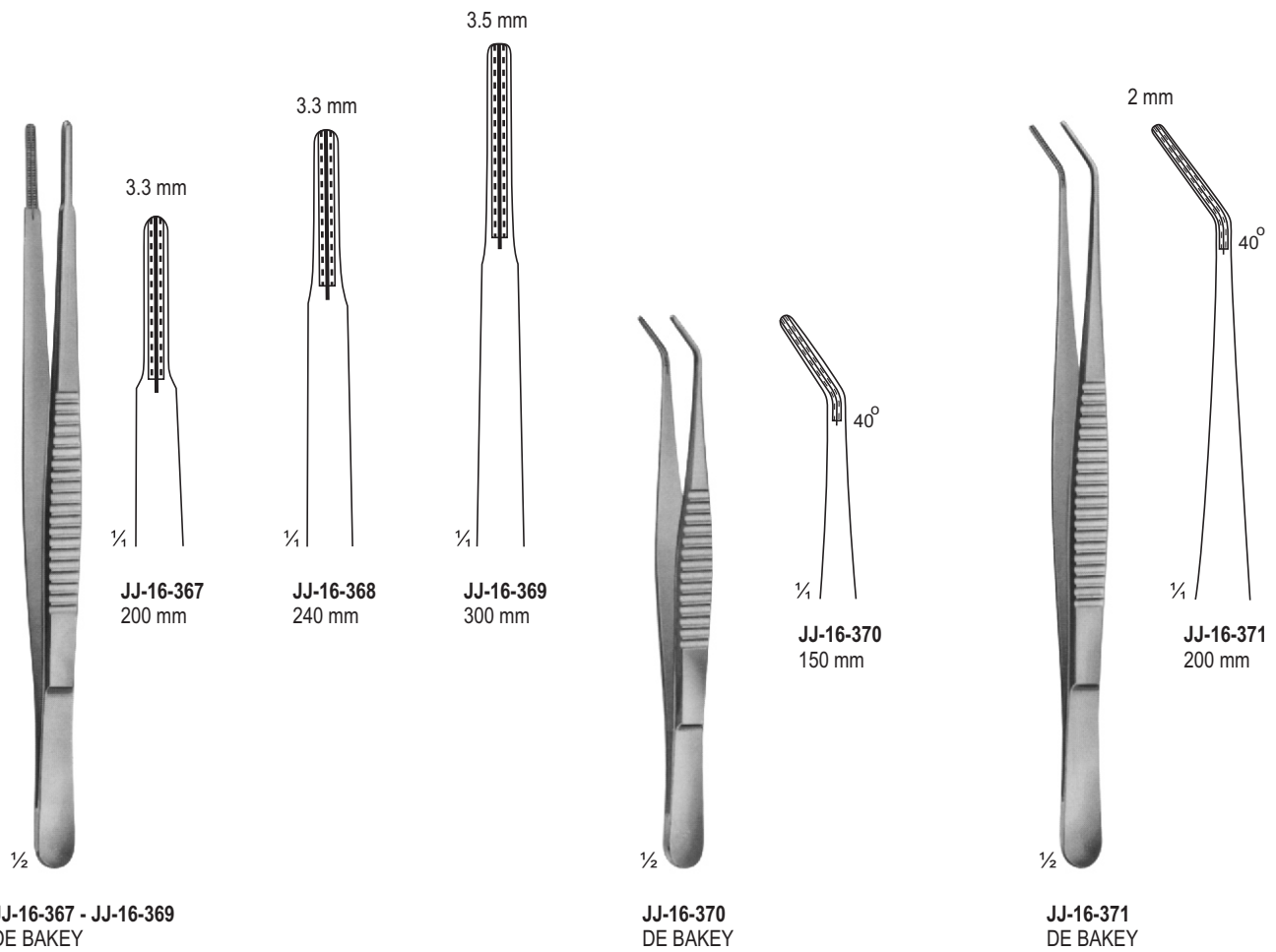

ULTRA - LIGHT - FORCEPS, DISSECTING FORCEPS



JJ-16-372 1,2 mm
JJ-16-373 1,5 mm
JJ-16-374 1,5 mm
JJ-16-375 1,5 mm

½

- JJ-16-372** 150 mm
- JJ-16-373** 200 mm
- JJ-16-374** 240 mm
- JJ-16-375** 300 mm



JJ-16-376 2 mm
JJ-16-377 2 mm
JJ-16-378 2 mm
JJ-16-379 2 mm

½

- DE BAKEY
- JJ-16-376** 150 mm
 - JJ-16-377** 200 mm
 - JJ-16-378** 240 mm
 - JJ-16-379** 300 mm



JJ-16-380 2,8 mm
JJ-16-381 2,8 mm
JJ-16-382 2,8 mm
JJ-16-383 2,8 mm

½

- DE BAKEY
- JJ-16-380** 150 mm
 - JJ-16-381** 200 mm
 - JJ-16-382** 240 mm
 - JJ-16-383** 300 mm

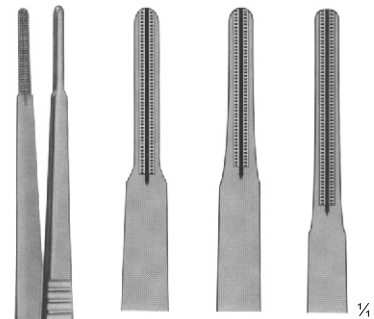

JJ-16-384 3,3 mm
JJ-16-385 3,3mm
JJ-16-386 3,3mm

½

- DE BAKEY
- JJ-16-384** 200 mm
 - JJ-16-385** 240 mm
 - JJ-16-386** 300 mm

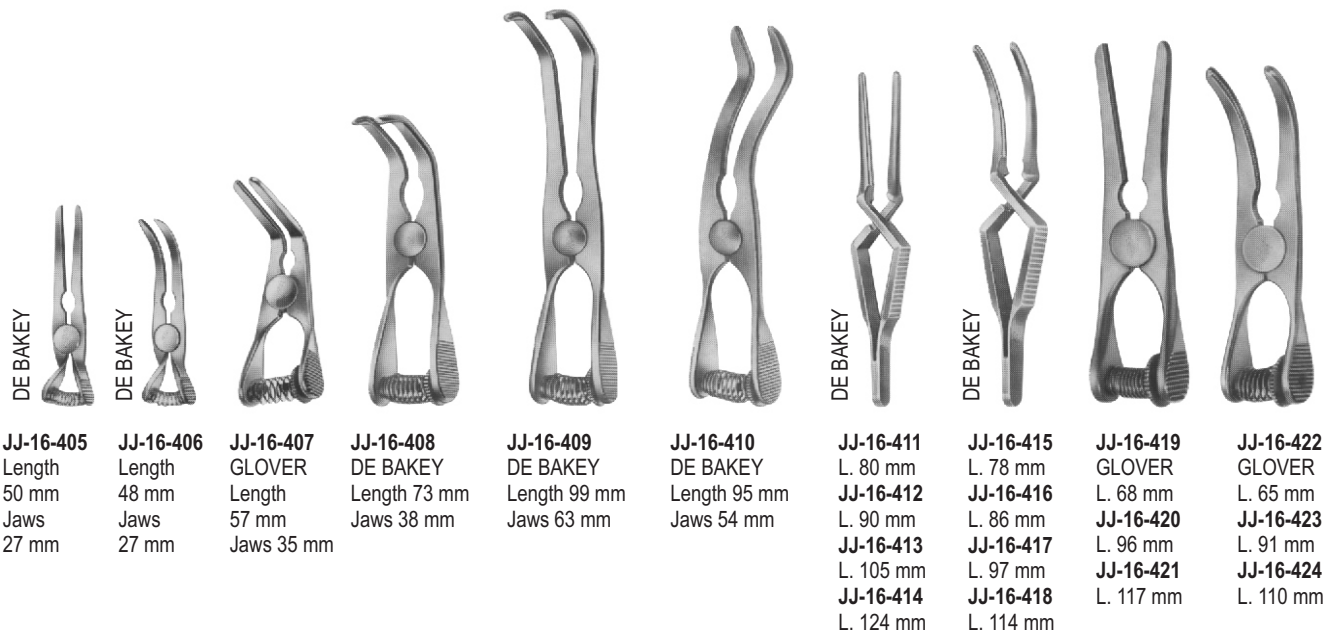
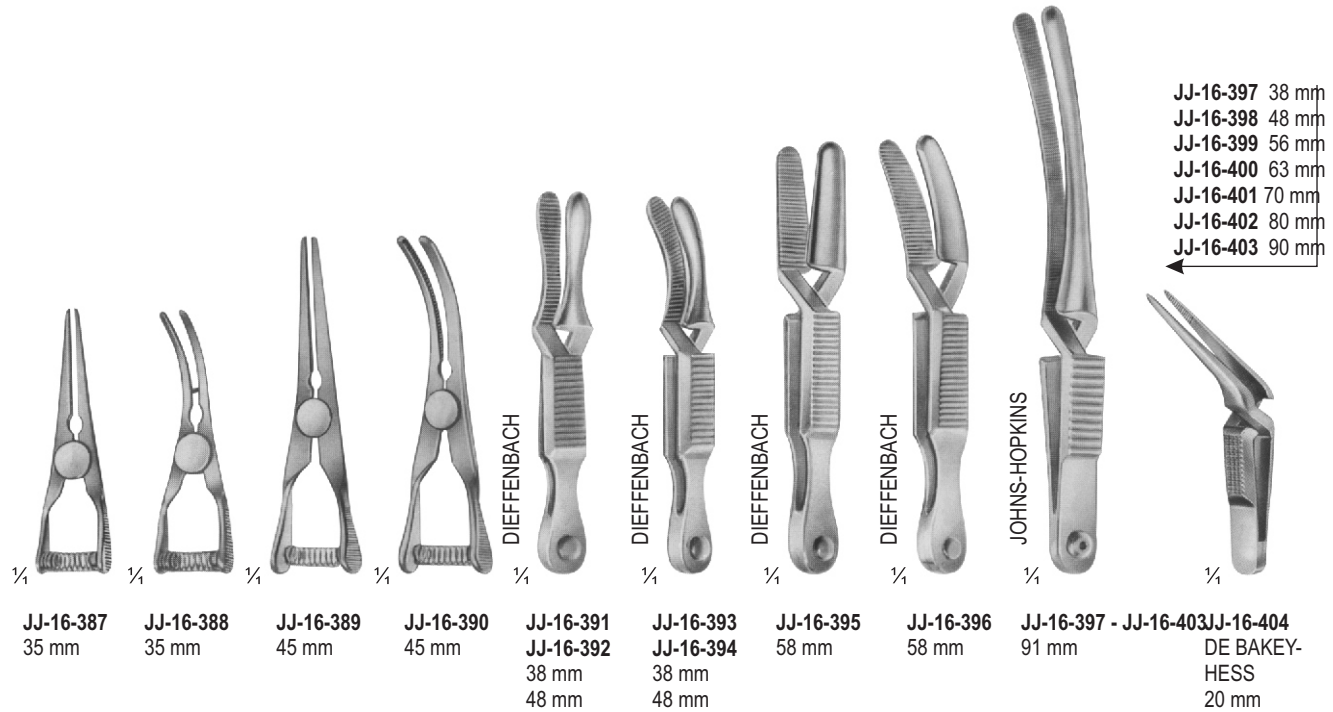

VASCULAR DILATORS

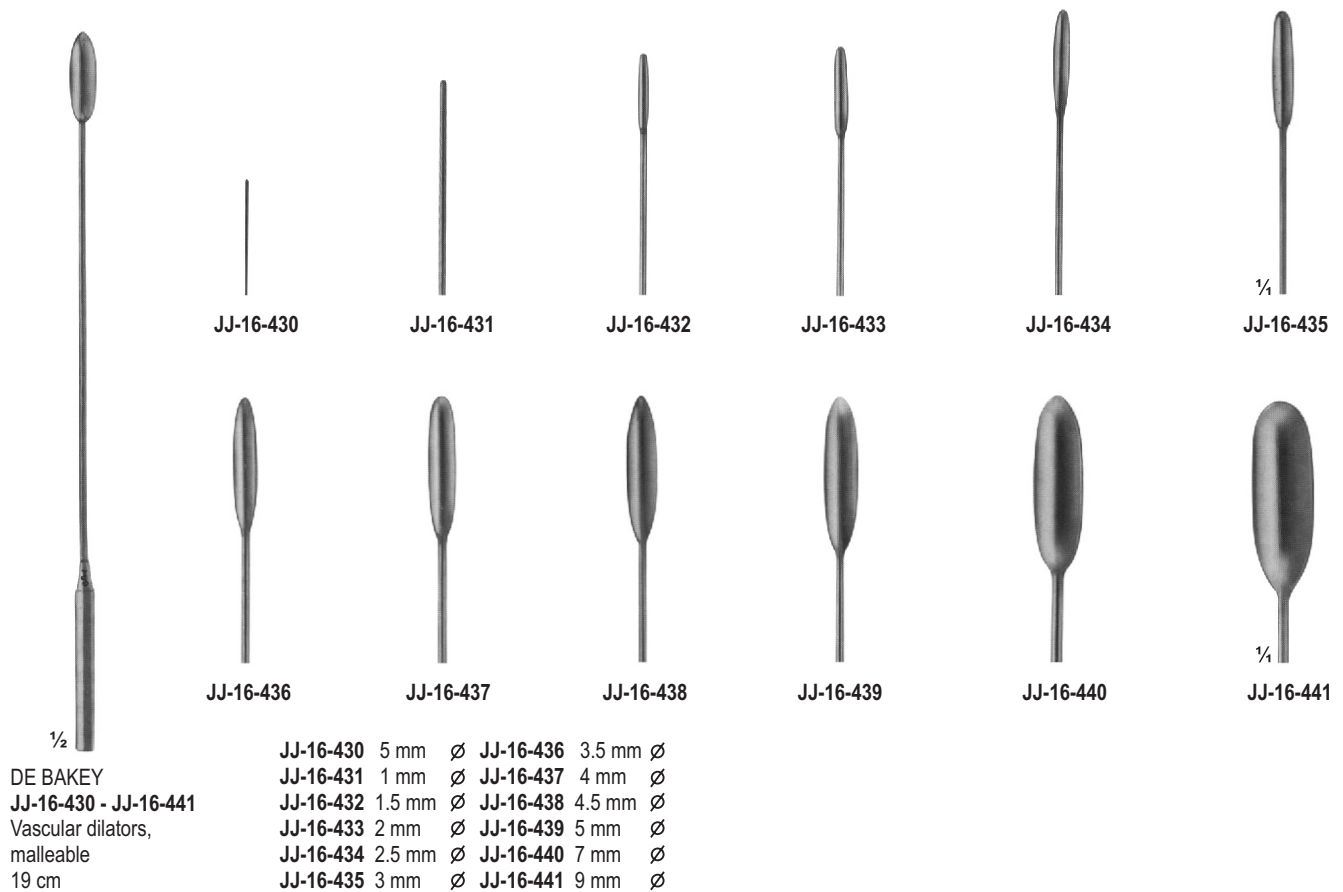
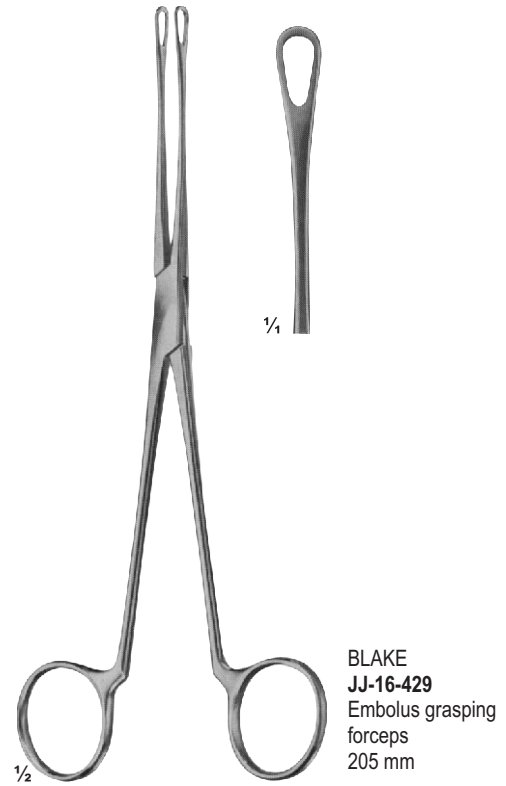
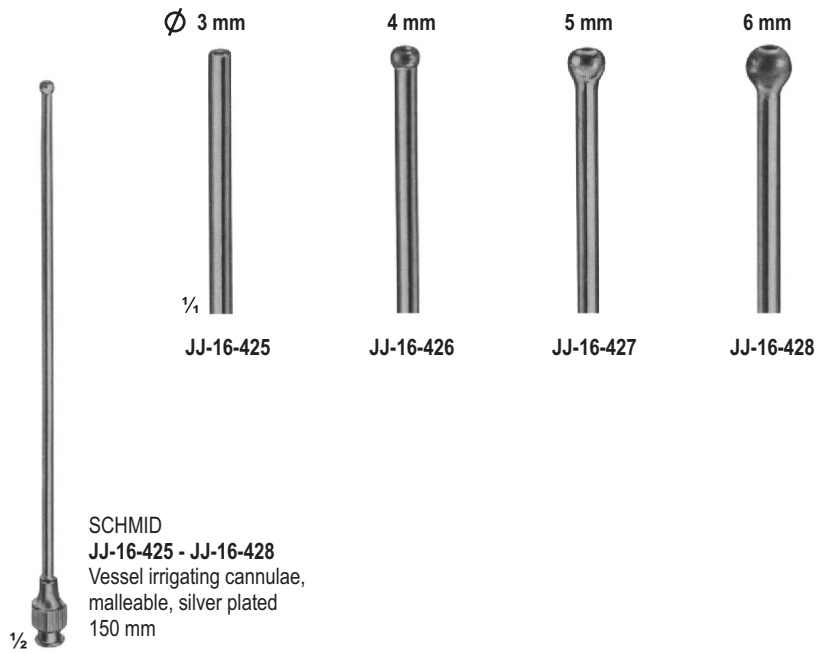

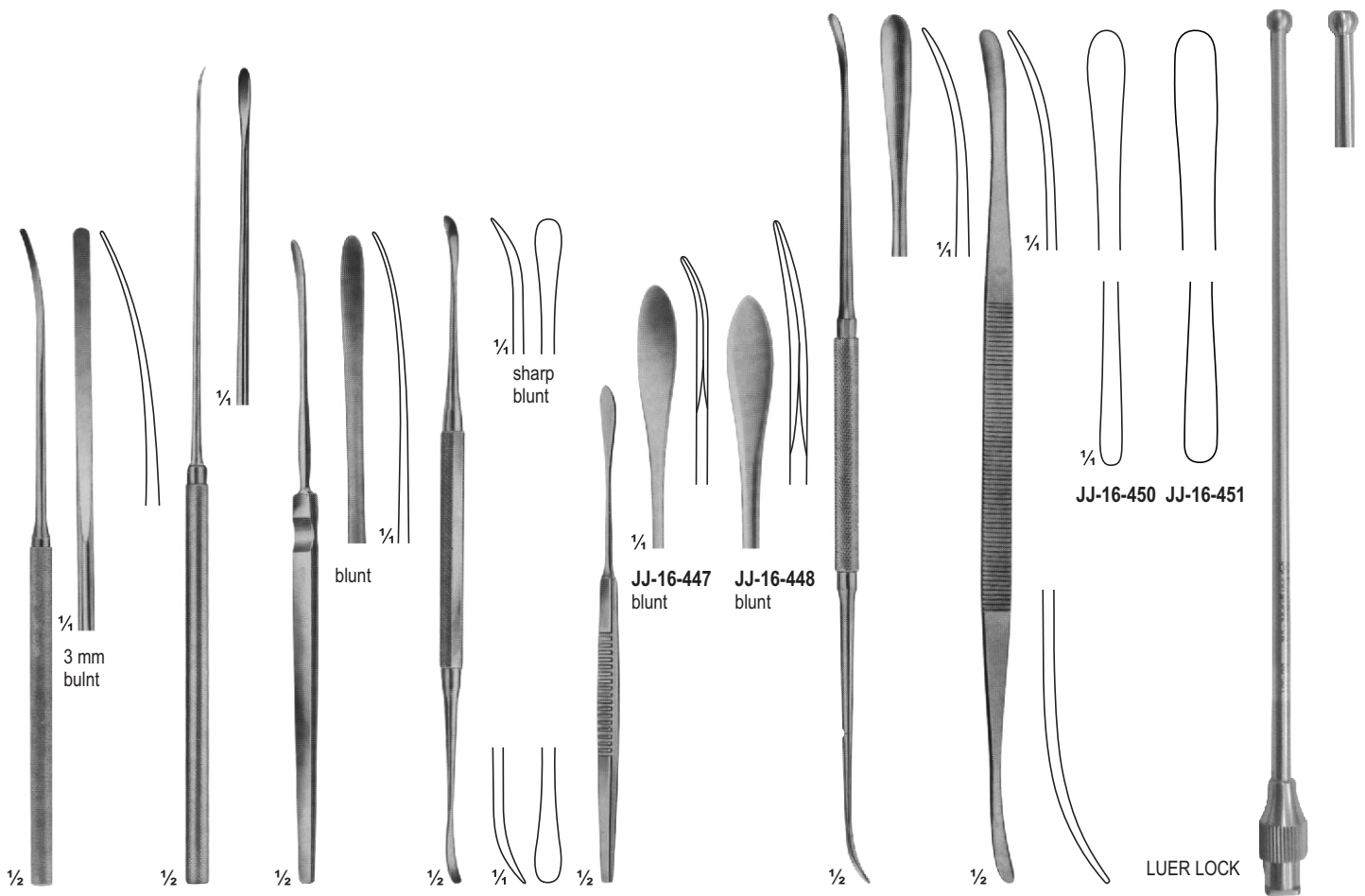

JJ-16-442
180 mm
JJ-16-443
215 mm

JJ-16-444
230 mm

JJ-16-445
HALLE
180 mm

JJ-16-446
FREER
sharp/blunt
185 mm

JJ-16-447 - JJ-16-448
SCHMID
140 mm
235 mm

JJ-16-449
DAVIS
245 mm

JJ-16-450 - JJ-16-451
TONNIS
240 mm

JJ-16-452
SCHMID
Vessel Irrigating
Cannulae
150 mm, 6"
3, 4, 5, 6 mm

INTIMA SPATULAS, VASCULAR DILATORS

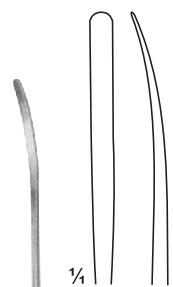

JJ-16-453
18.5 cm
JJ-16-454
21.5 cm

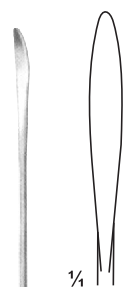

JJ-16-455
14 cm



JJ-16-456
23.5 cm

1/2

JJ-16-453 - JJ-16-454

1/2

JJ-16-455 - JJ-16-456



1/4
5 mm

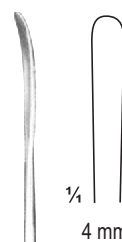

1/4
4 mm



1/4
3 mm

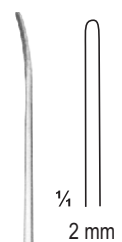

1/4
2 mm

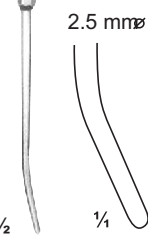

2.5 mmø

1/2

1/4

Fig. 1
ROBB
JJ-16-457
24 cm

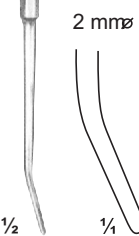

2 mmø

1/2

1/4

Fig. 2
ROBB
JJ-16-458
24 cm

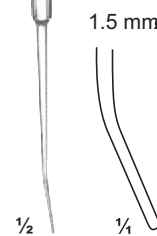

1.5 mmø

1/2

1/4

Fig. 3
ROBB
JJ-16-459
24 cm

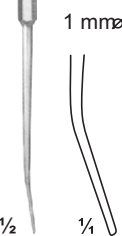

1 mmø

1/2

1/4

Fig. 4
ROBB
JJ-16-460
24 cm



CRILE
JJ-16-461
20 cm



1/4



CRILE
JJ-16-462
20.5 cm



1/4



JJ-16-463 - JJ-16-466
26 cm



1/4

JJ-16-463
1.5 mm ø



JJ-16-464
2 mm ø



JJ-16-465
2.5 mm ø



JJ-16-466
3 mm ø

NERVE HOOKLETS, TOURNIQUETS

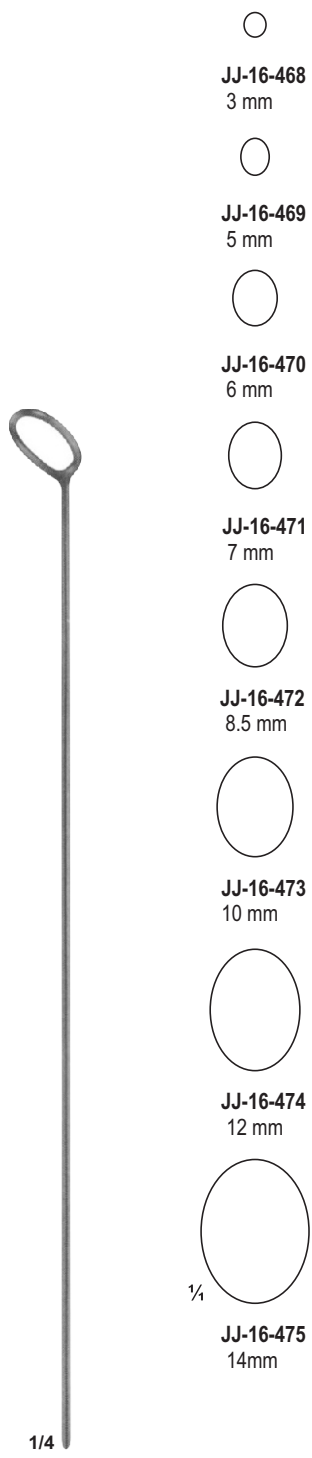

- **JJ-16-468**
3 mm
- **JJ-16-469**
5 mm
- **JJ-16-470**
6 mm
- **JJ-16-471**
7 mm
- **JJ-16-472**
8.5 mm
- **JJ-16-473**
10 mm
- **JJ-16-474**
12 mm
- **JJ-16-475**
14mm

JJ-16-467 - JJ-16-475
Endarterectomy strippers
55 cm



JJ-16-476
Handle for
11 cm

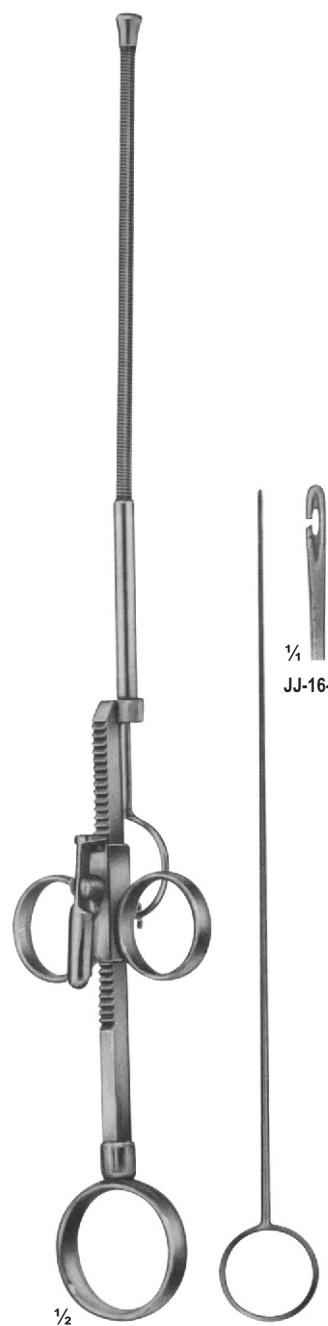

RUMEL-BELBONT
JJ-16-477 - JJ-16-478
32.5 cm
JJ-16-477 - 4 mm Ø
JJ-16-478 - 6.4 mm Ø

JJ-16-479 - JJ-16-480
Guide only

JJ-16-479 JJ-16-480

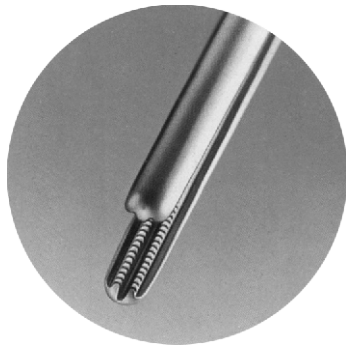
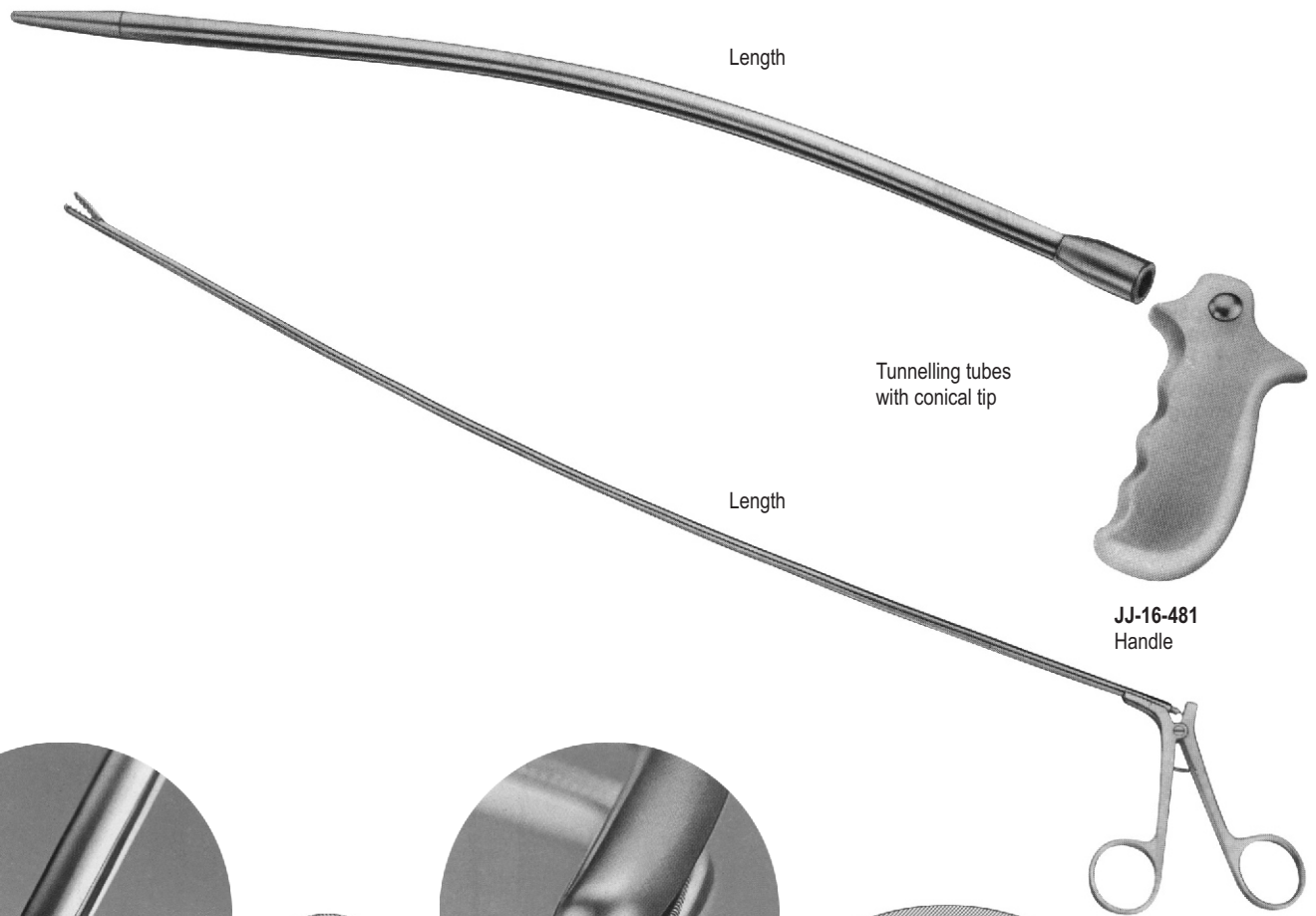

DE BAKEY
JJ-16-482
1 : 2 rows of teeth

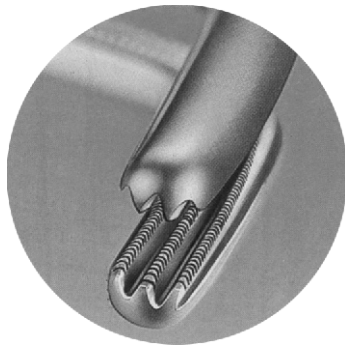
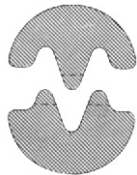

DE BAKEY
JJ-16-483
2 : 3 rows of teeth

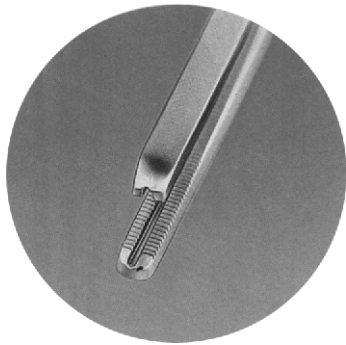
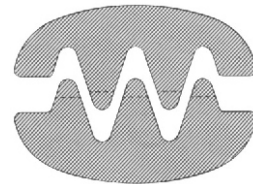

COOLEY
JJ-16-484
2 : 2 rows of teeth

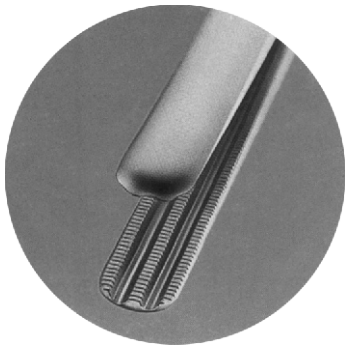
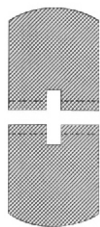

DARDIK
JJ-16-485
2 : 3 rows of teeth

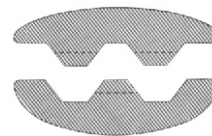

AORTIC DILATORS

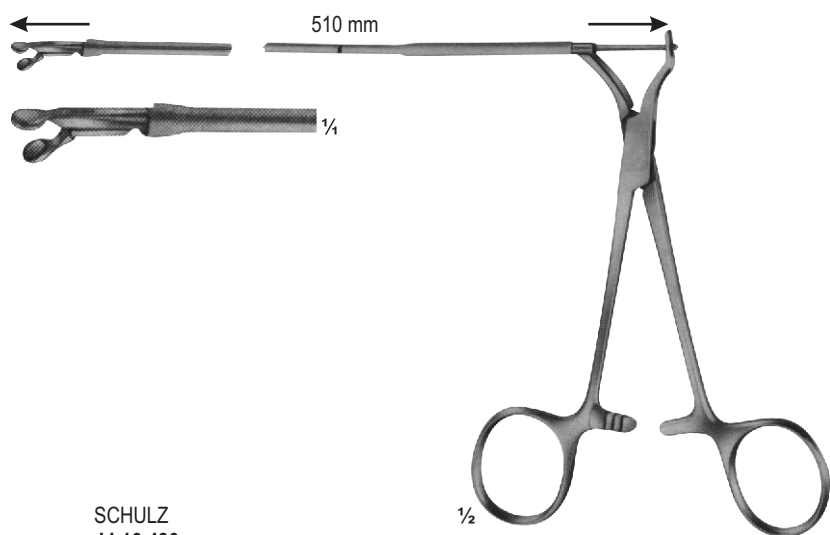

**SCHULZ
JJ-16-486**

Biopptome, mit flexiblen Schaft, 510 mm lang,
with round jaws 3 mm diam.

Biopsy forceps, for biopsy from the right atrium
through cava juglaris, prior to heart implantations.

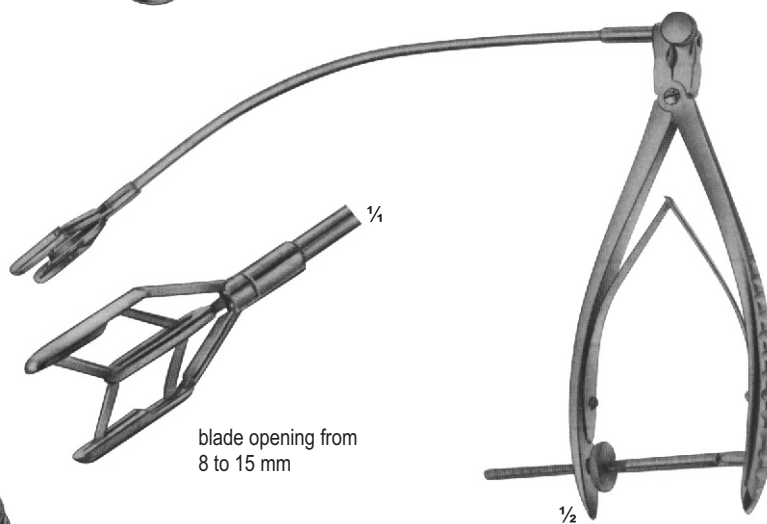

blade opening from
8 to 15 mm

**COOLEY
JJ-16-487**
Dilator for
mitral valve
for children

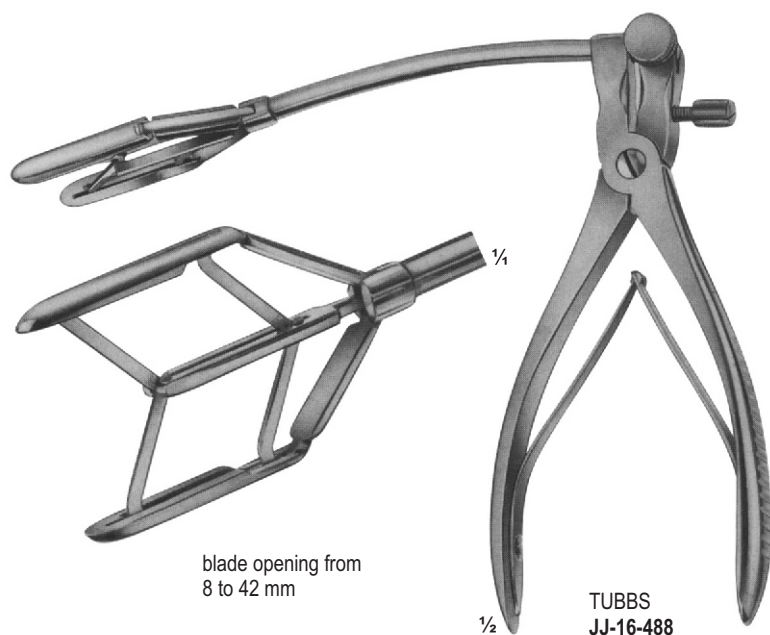

blade opening from
8 to 42 mm

**TUBBS
JJ-16-488**
Dilator for
mitral valve

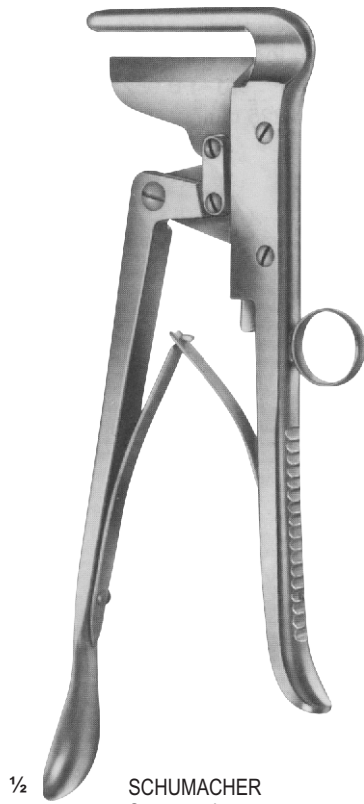

1/2 SCHUMACHER
Sternum shears
JJ-16-489
210 mm



1/3 GIERTZ-STILLE
JJ-16-490
250 mm

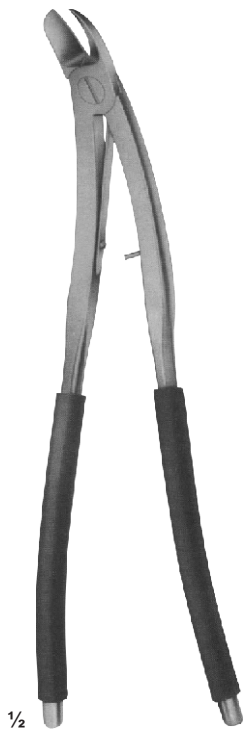

1/2 GLUCK
JJ-16-491
190 mm



1/3 BRUNNER
Universal Pattern
JJ-16-492
340 mm

RIB HOLDING FORCEPS



JJ-16-493
SEMB
Rib-and Bone
Holding forceps
190 mm



JJ-16-494
SEMB
Rib-and Bone
Holding forceps
190 mm

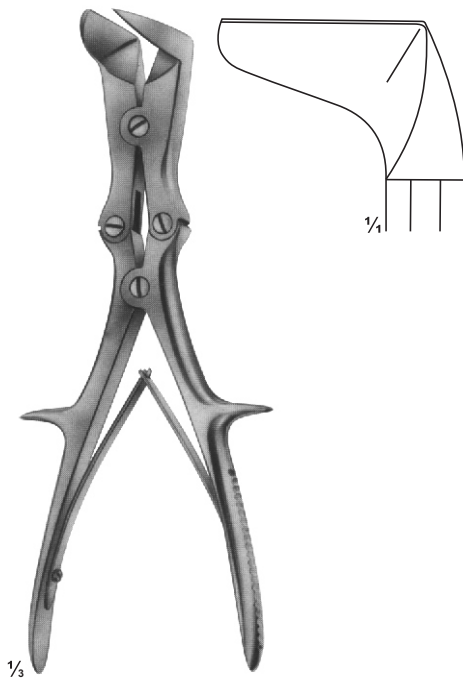

JJ-16-495
LISTON-STILLE
265 mm

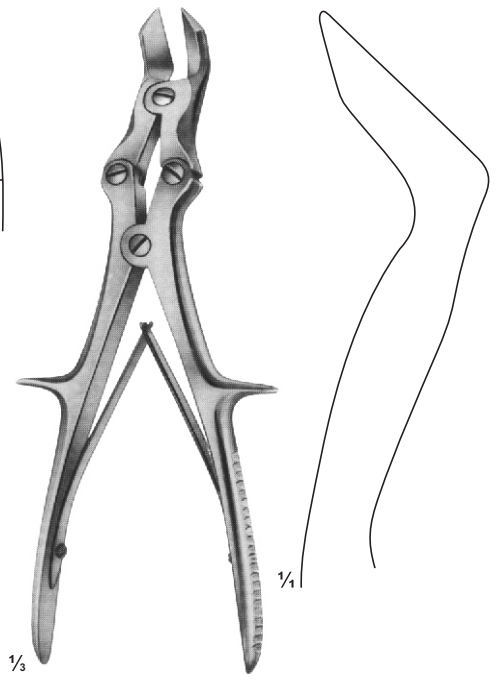

JJ-16-496
LISTON-KEY-HORSLEY
255 mm

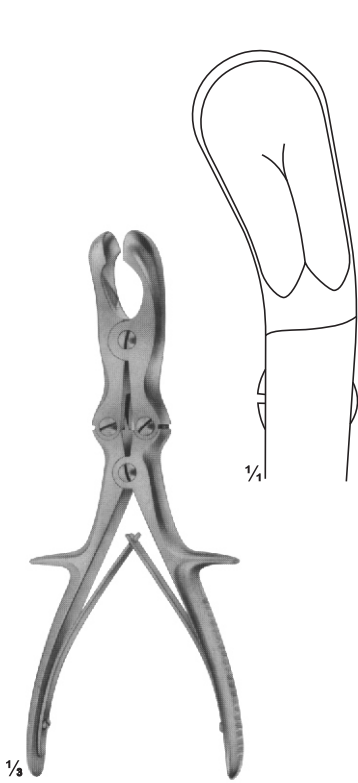

JJ-16-497
SEME
Rib Rongeur to shorten
the rib stumps
240 mm

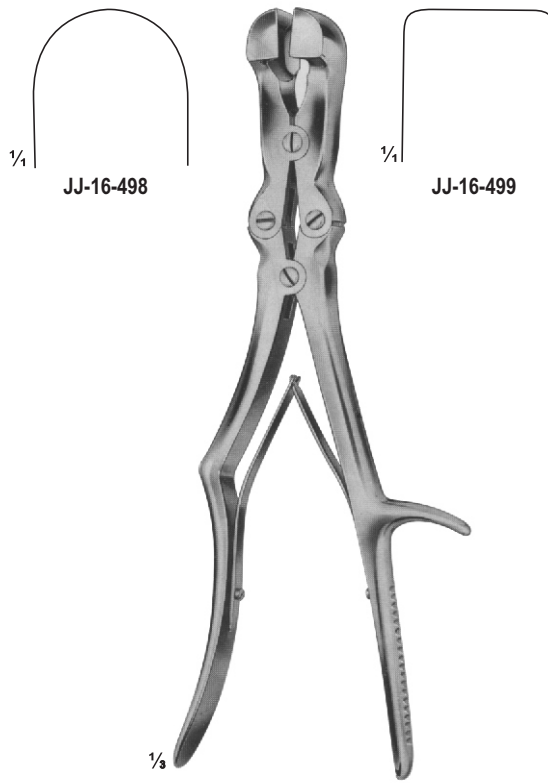

JJ-16-498 - JJ-16-499
SAUERDRUCH-CORYLLOS
Rib rongeurs to shorten
the rib stumps
310 mm

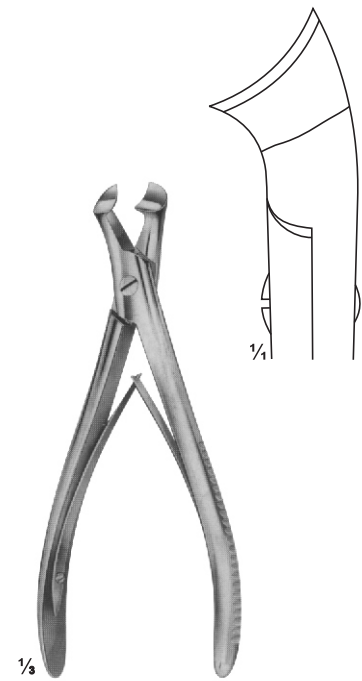

JJ-16-500
MARKWALDER
Rib Rongeur to Round
the rib stumps
190 mm

RIB RASPATORIES

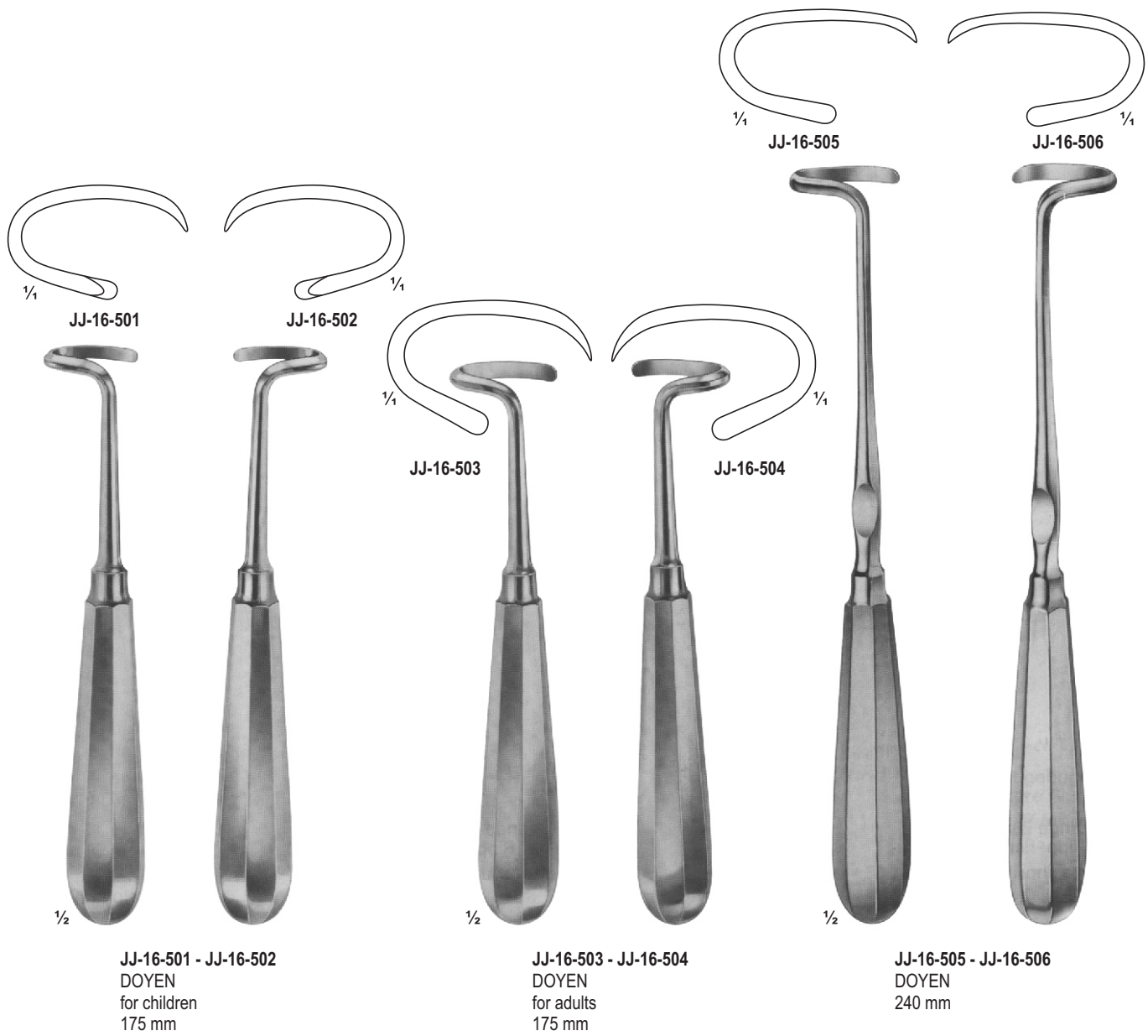



1/2
JJ-16-507 - JJ-16-511
SEMB
230 mm

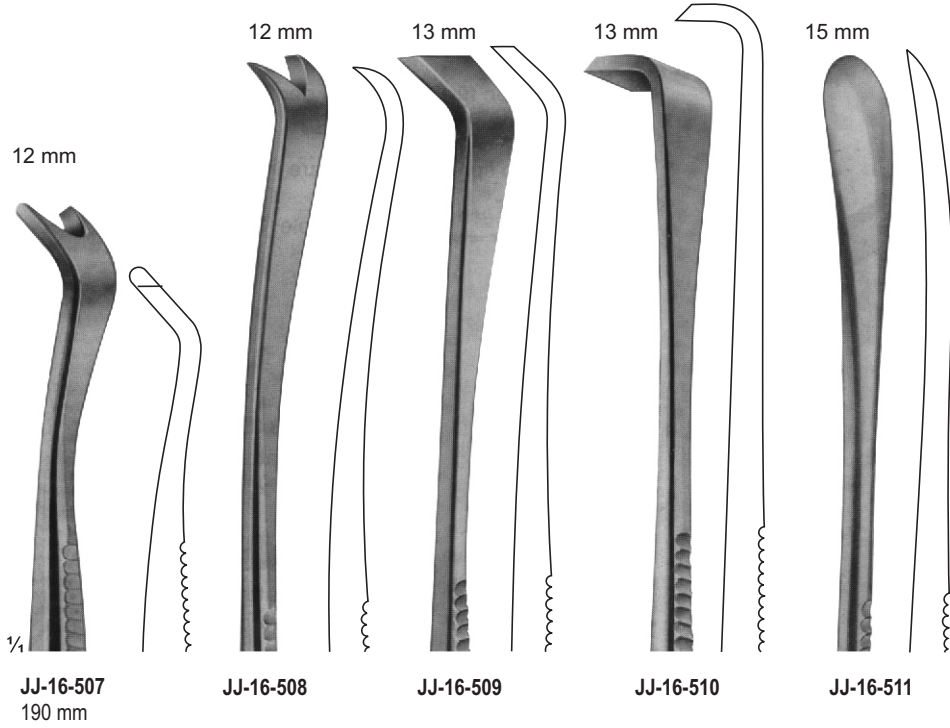

1/4
JJ-16-507
190 mm

JJ-16-508

JJ-16-509

JJ-16-510

JJ-16-511

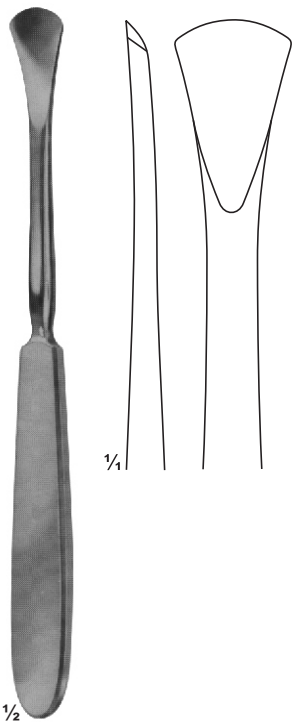

1/2
JJ-16-512
LANGENBECK
190 mm

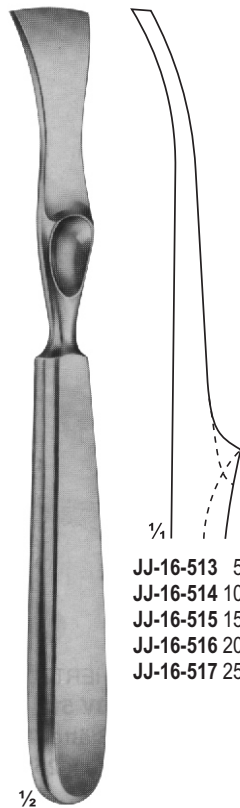

1/2
JJ-16-513 - JJ-16-517
LAMBOTTE
215 mm

- JJ-16-513 5 mm
- JJ-16-514 10 mm
- JJ-16-515 15 mm
- JJ-16-516 20 mm
- JJ-16-517 25 mm

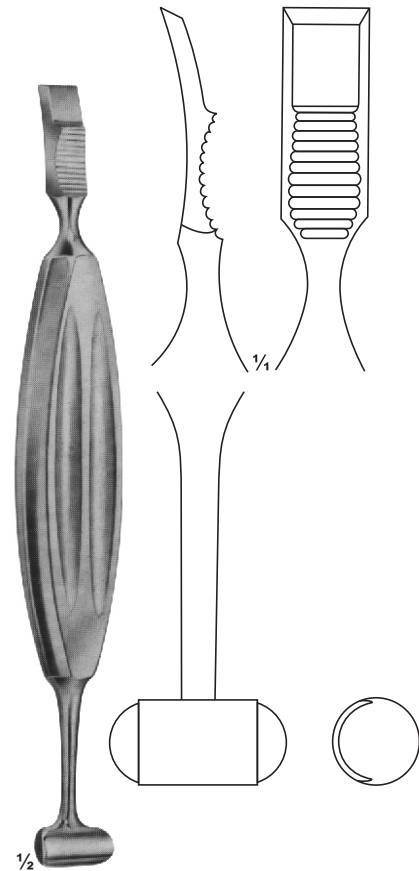

1/2
JJ-16-518
ALEXANDER
210 mm

Page 375–395

- Needle Holders
- Suture Instruments
- Ligature Needles
- Guiding Probes

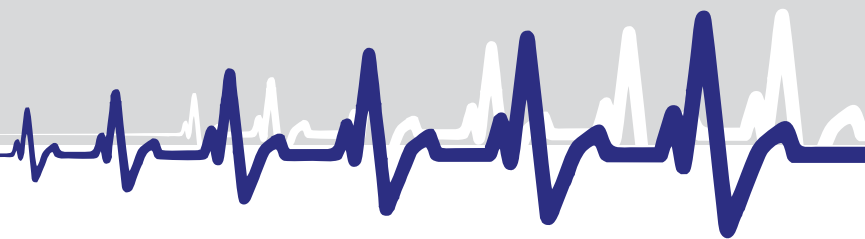

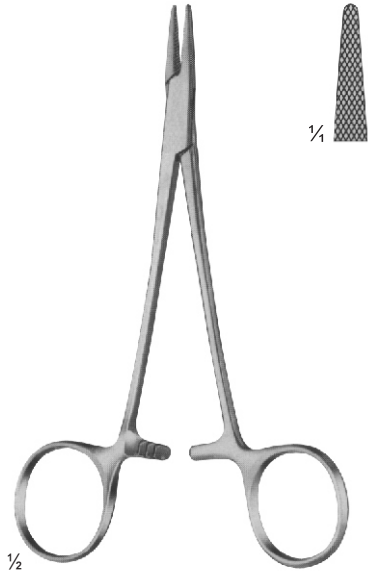

CRILE-MURRAY
JJ-17-101
15 cm



CRILE-WOOD
JJ-17-102
16 cm

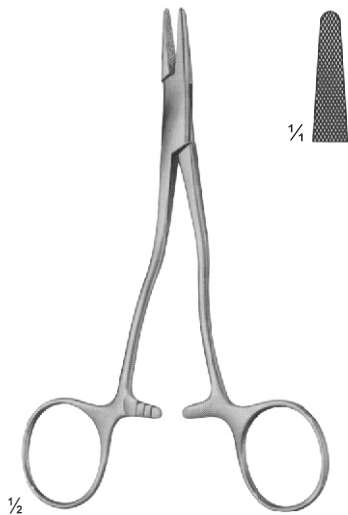

KILNER
JJ-17-103
13.5 cm



ADSON
JJ-17-104
17.5 cm

NEEDLE HOLDERS

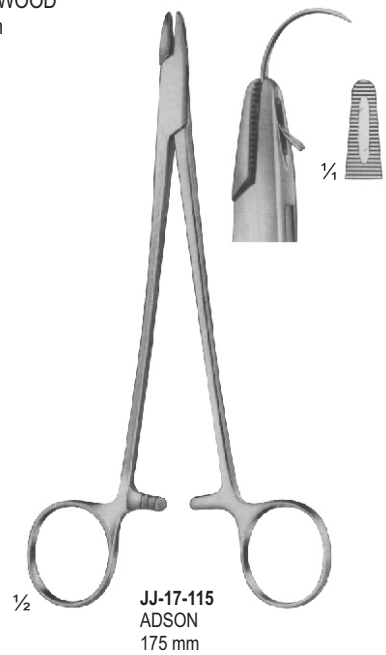
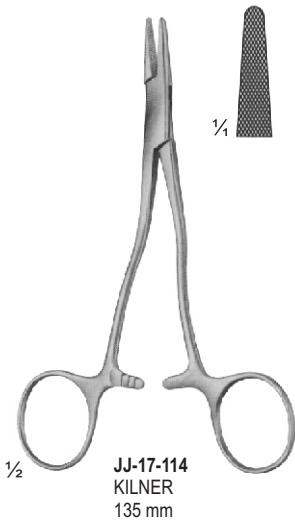
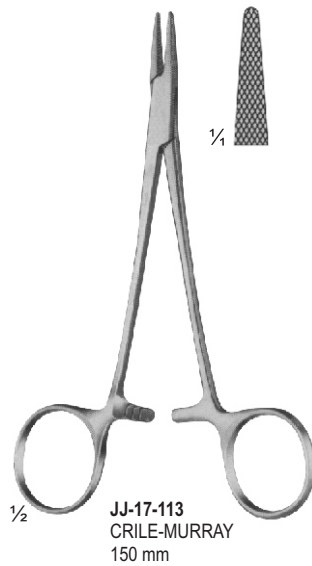
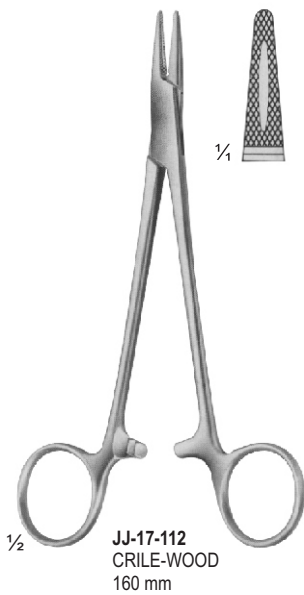
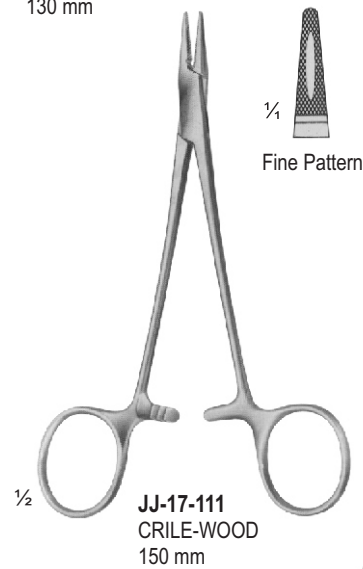
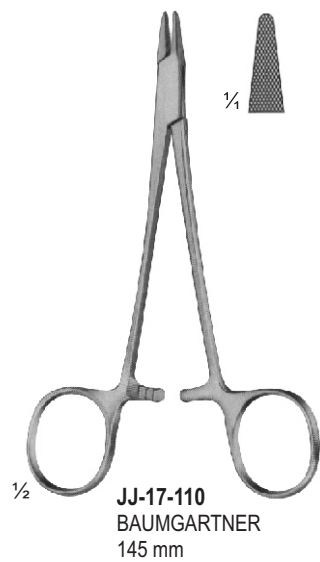
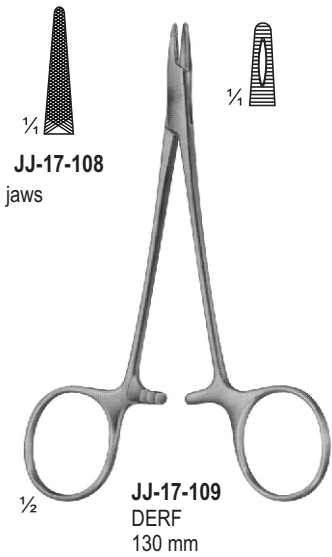
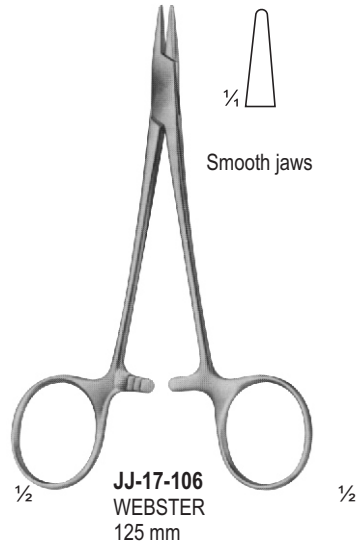
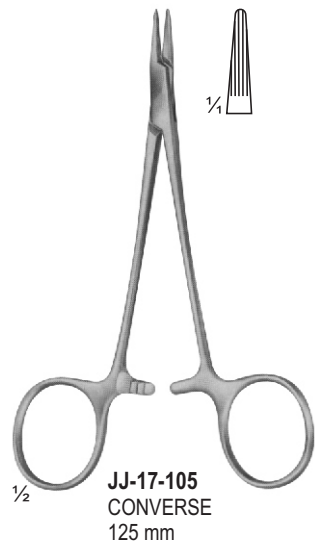

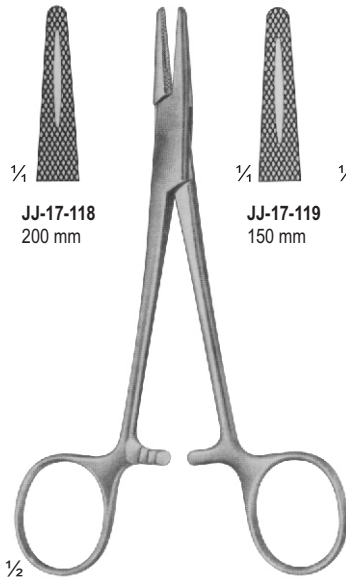
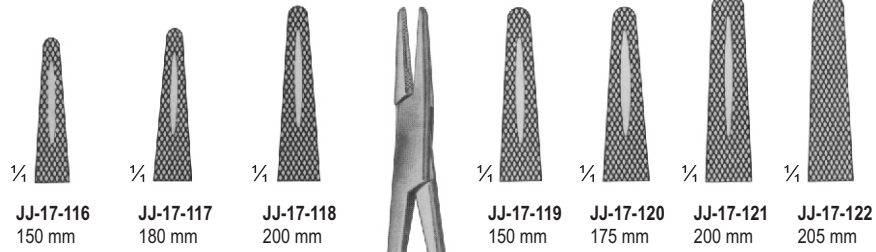

JJ-17-119 - JJ-17-122
HEGAR
Heavy Patterns

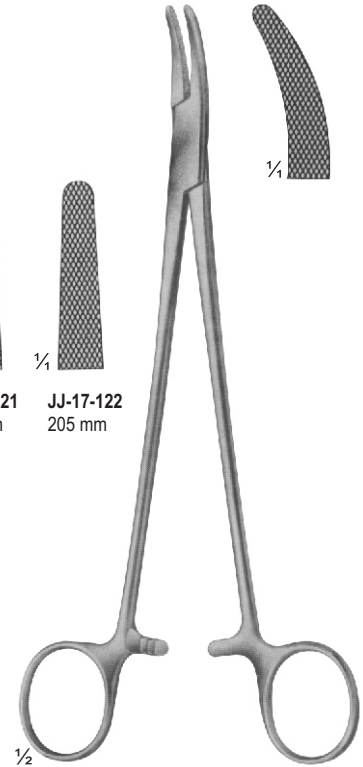

JJ-17-123
HEANEY (HEGAR)
200 mm

1/2

JJ-17-116 - JJ-17-118
MAYO-HEGAR
Medium fine patterns

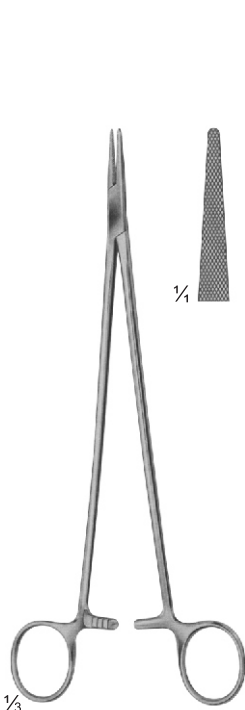

JJ-17-124
JAMESON
230 mm

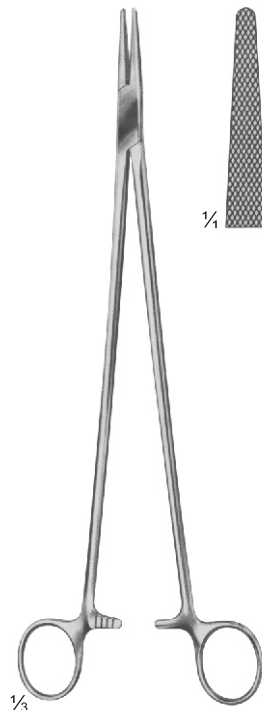

JJ-17-125
WANGENSTEEN
275 mm



JJ-17-126
MASSON
265 mm

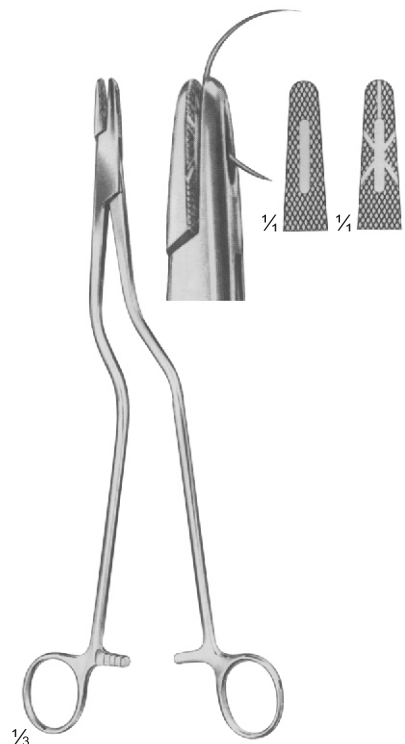

JJ-17-127
MASSON-LUETHY
255 mm

1/3

1/3

1/3

1/3

NEEDLE HOLDERS

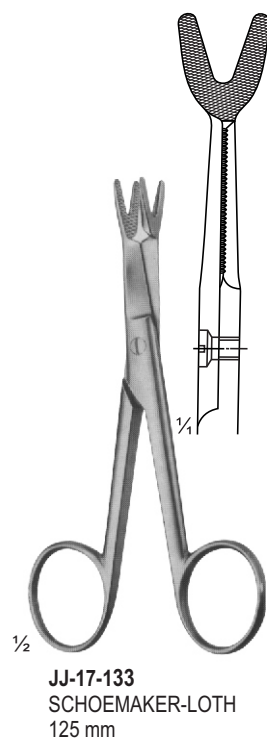
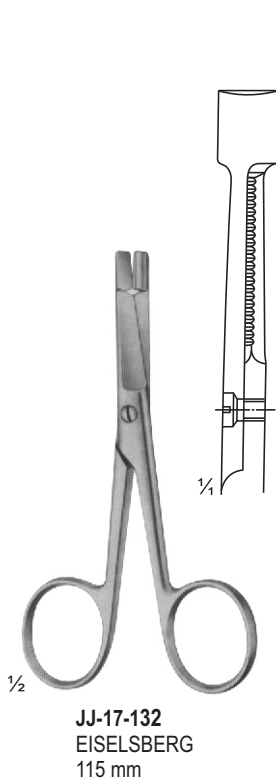
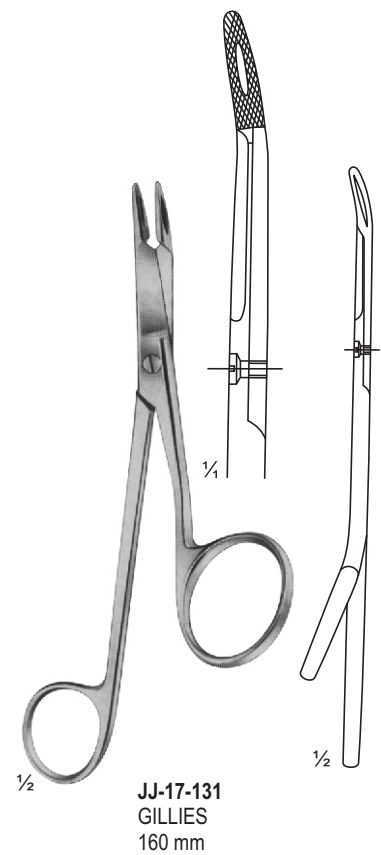
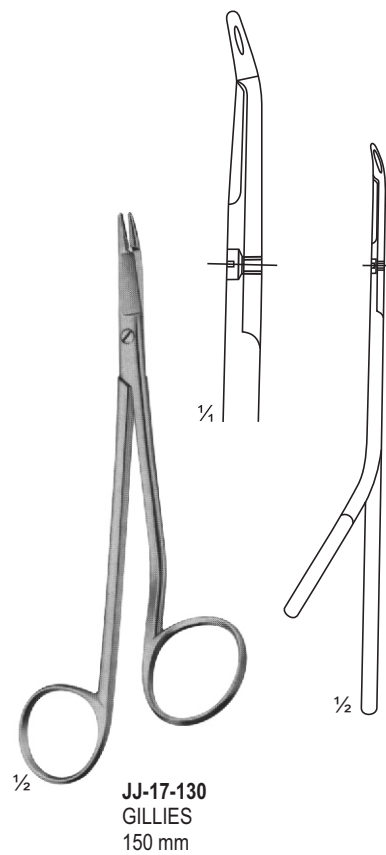
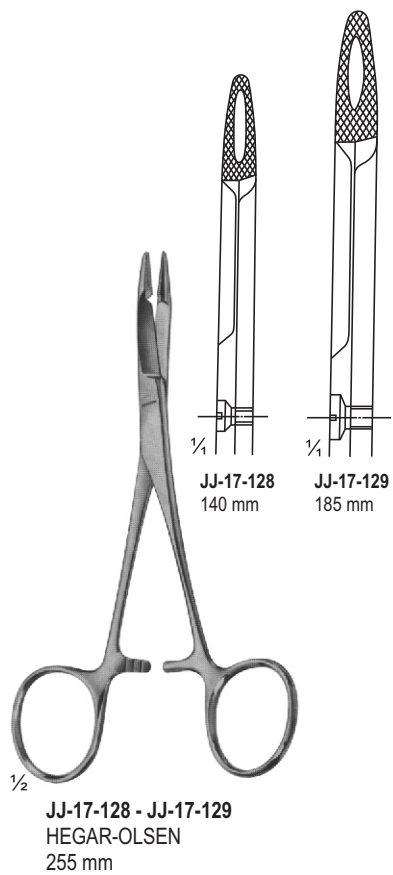

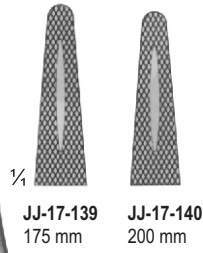
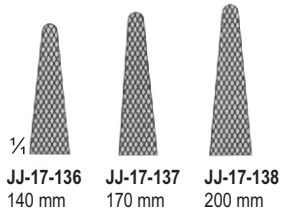

1/2
JJ-17-136 - JJ-17-138
MATHIEU

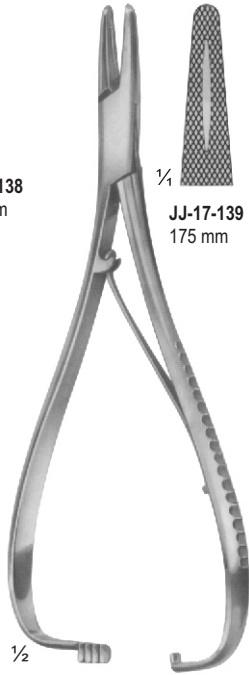

JJ-17-139 - JJ-17-140
MATHIEU-STILLE
Very heavy models

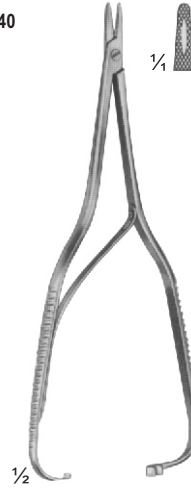

JJ-17-141
BOYNTON
125 mm



JJ-17-142
EISELSBERG-MATHIEU
For palate suture
195 mm



JJ-17-143
MATHIEU-KOCHER

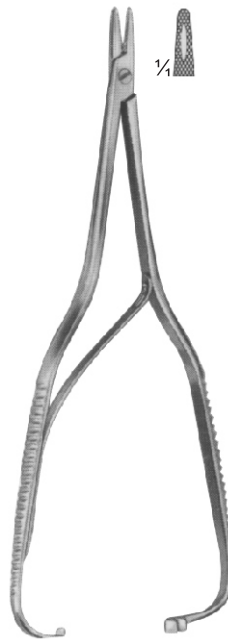

JJ-17-144
BOYNTON
125 mm



JJ-17-145
MILLIN
Ligature holding forceps
245 mm

SUTURE INSTRUMENTS - REVERDIN NEEDLES

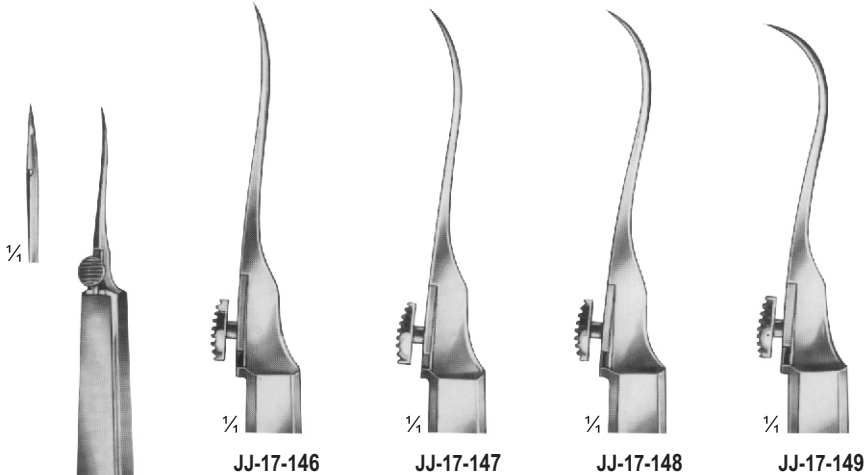

JJ-17-146 - JJ-17-149
REVERDIN
140 mm

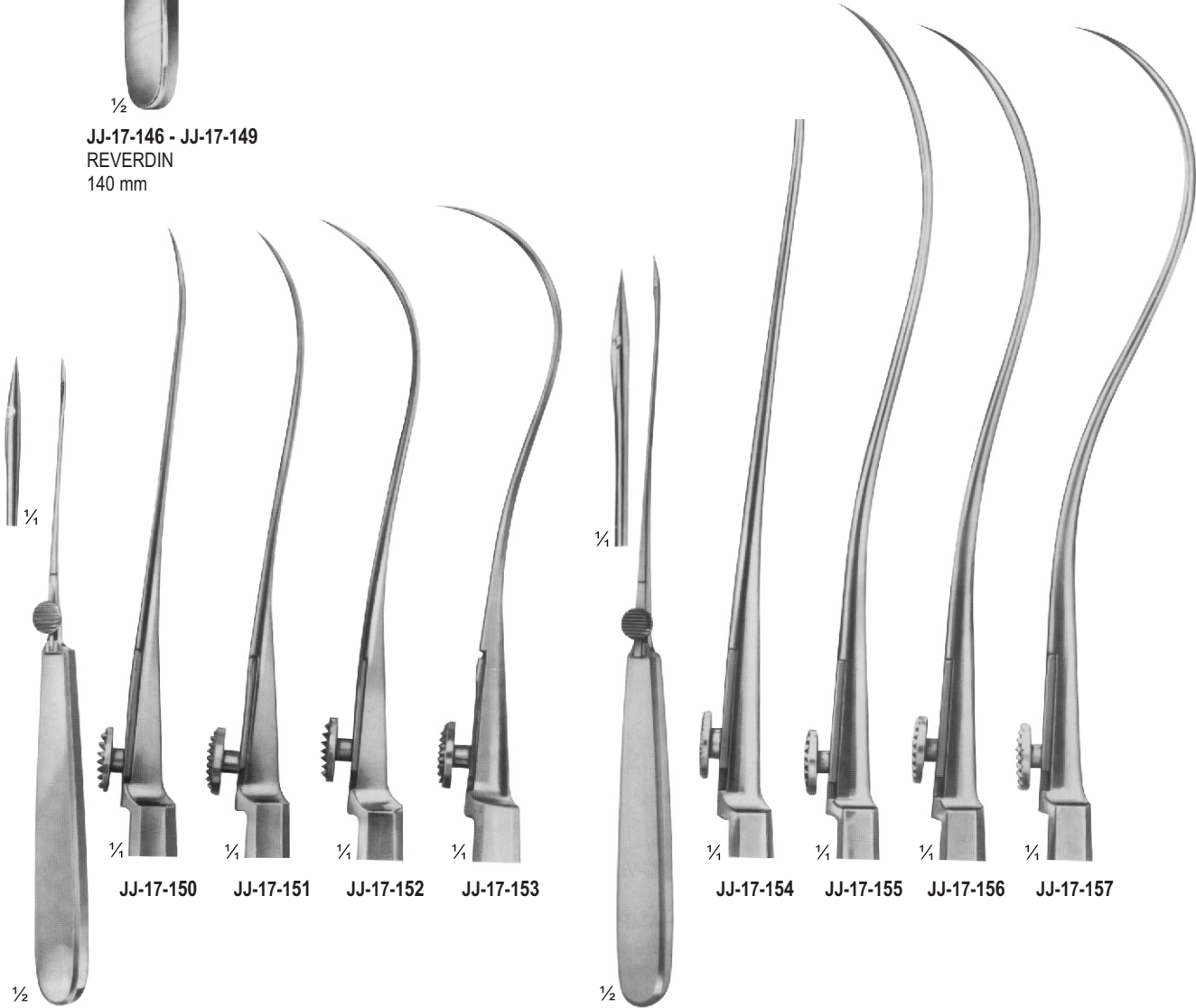

JJ-17-150 - JJ-17-153
REVERDIN
195 mm

JJ-17-154 - JJ-17-157
REVERDIN
220 mm



JJ-17-158
KRONECKER
for right hand
blunt
155 mm



JJ-17-159
KRONECKER
for left hand
blunt
155 mm



JJ-17-160
DESCHAMPS
for right hand
steep turn
225 mm

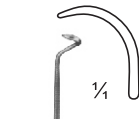

JJ-17-161
DESCHAMPS
for left hand
steep turn
225 mm



JJ-17-162
DESCHAMPS
for right hand
steep turn blunt
225 mm

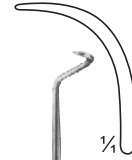

JJ-17-163
DESCHAMPS
for left hand
steep turn blunt
225 mm

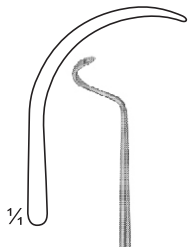

JJ-17-164
DESCHAMPS
for right hand
steep turn blunt
230 mm

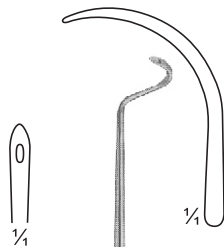

JJ-17-165
DESCHAMPS
for left hand
steep turn blunt
230 mm

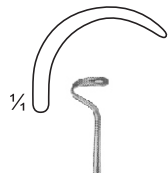

JJ-17-166
DESCHAMPS
for right hand blunt
215 mm



JJ-17-167
DESCHAMPS
for left hand blunt
215 mm



JJ-17-168
DESCHAMPS
for right hand blunt
215 mm



JJ-17-169
DESCHAMPS
for left hand blunt
215 mm

SUTURE INSTRUMENTS - LIGATURE NEEDLES

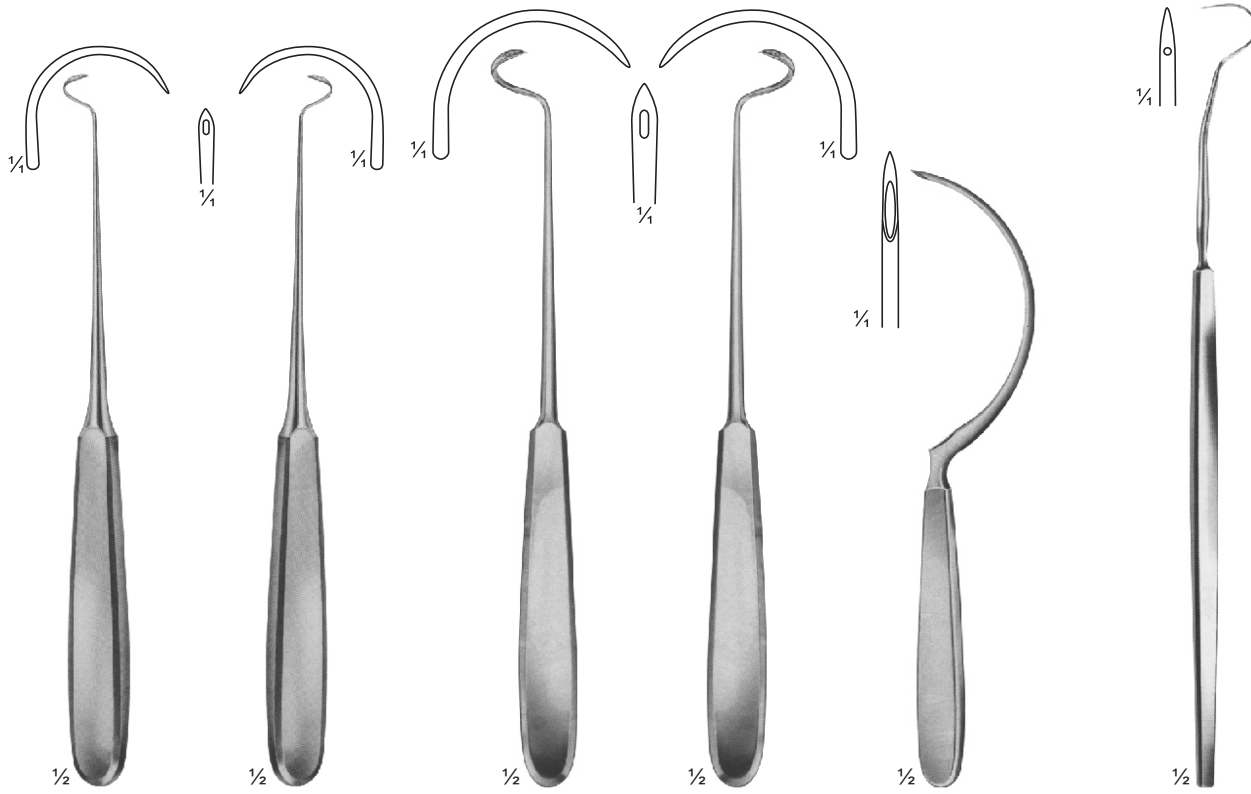

JJ-17-170
HURD
for right hand
sharp
210 mm

JJ-17-171
HURD
for left hand
sharp
210 mm

JJ-17-172
DESCHAMPS
for right hand
sharp
215 mm

JJ-17-173
DESCHAMPS
for left hand
sharp
215 mm

JJ-17-174
JONESCO
Needle for wire suture
185 mm

JJ-17-175
CLAUS VAN EICKEN
Needle for wire suture
250 mm

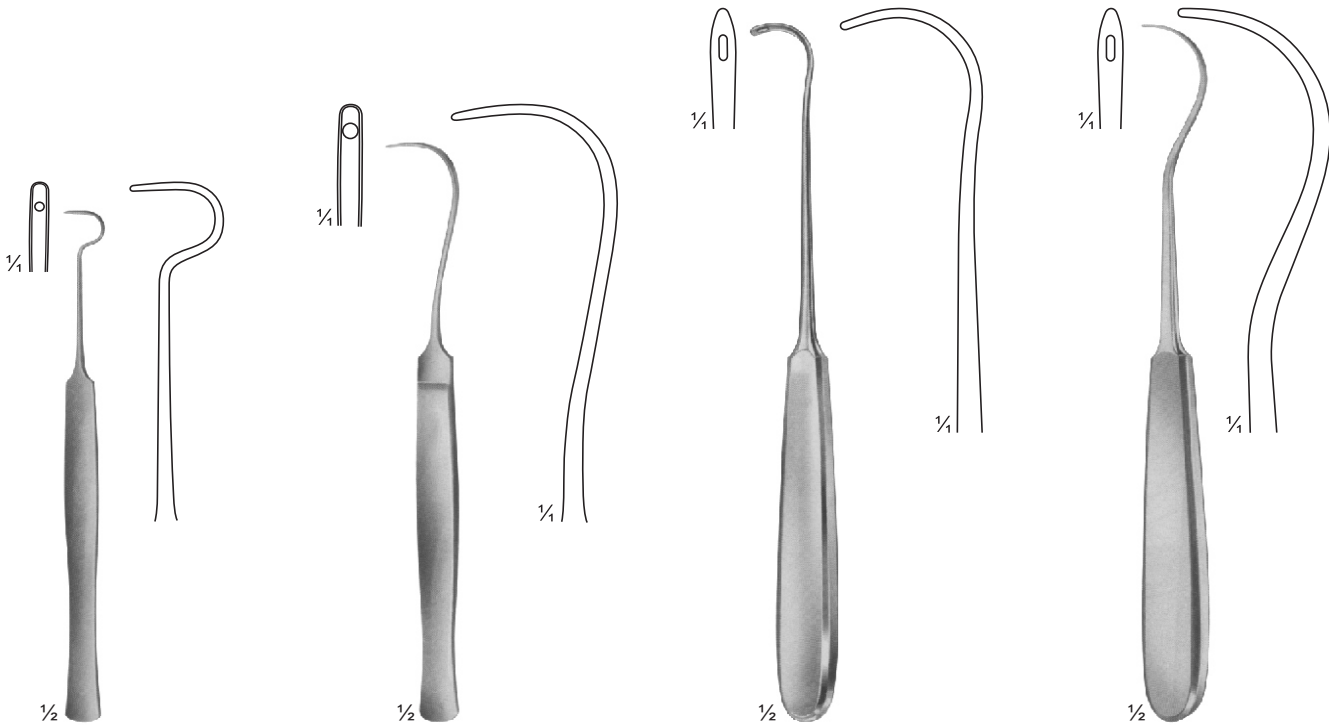

JJ-17-176
150 mm

JJ-17-177
SYME
170 mm

JJ-17-178
COOPER
205 mm

JJ-17-179
KOCHER
205 mm

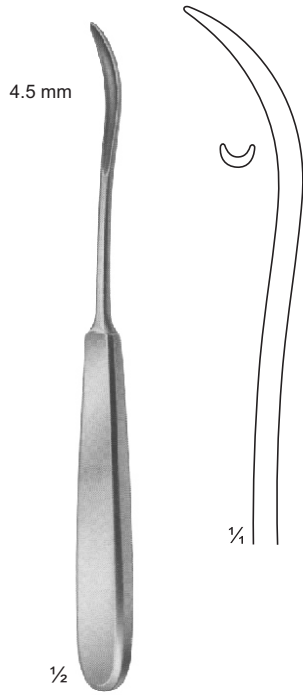

JJ-17-180
KOENIG
195 mm

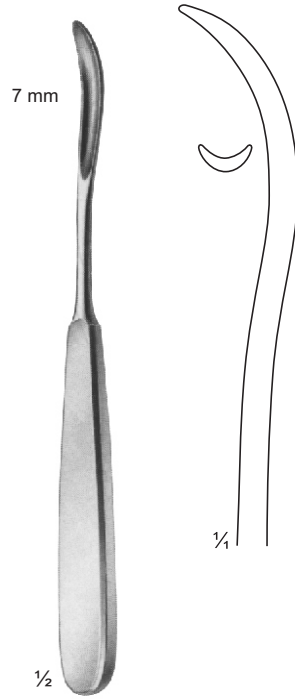

JJ-17-181
KOENIG
200 mm

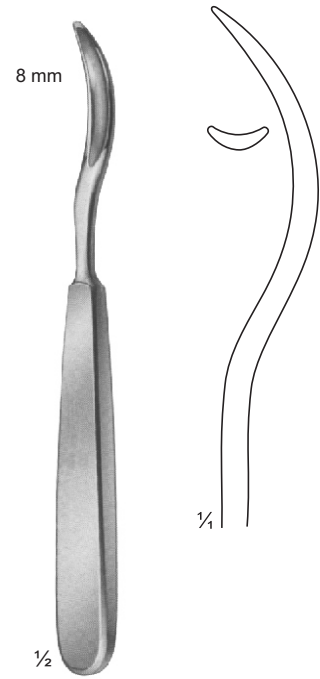

JJ-17-182
SCHMIEDEN
185 mm

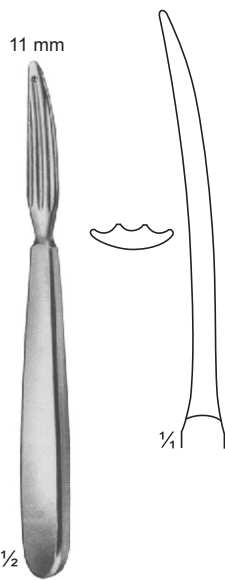

JJ-17-183
KOCHER
150 mm

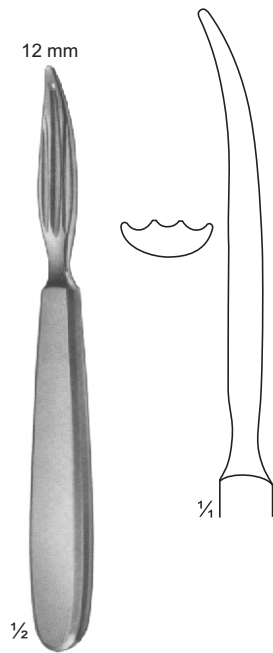

JJ-17-184
KOCHER
170 mm

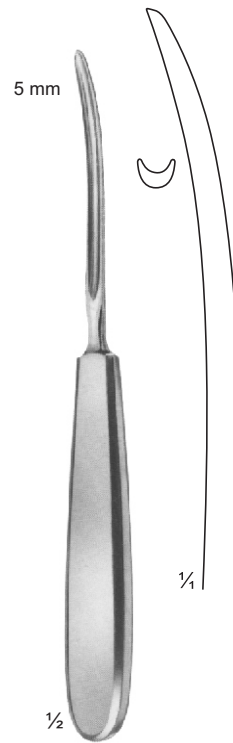

JJ-17-185
PAYR
195 mm

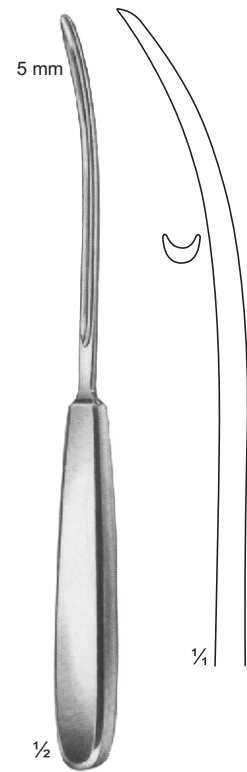

JJ-17-186
PAYR 225 mm

GUIDING PROBES

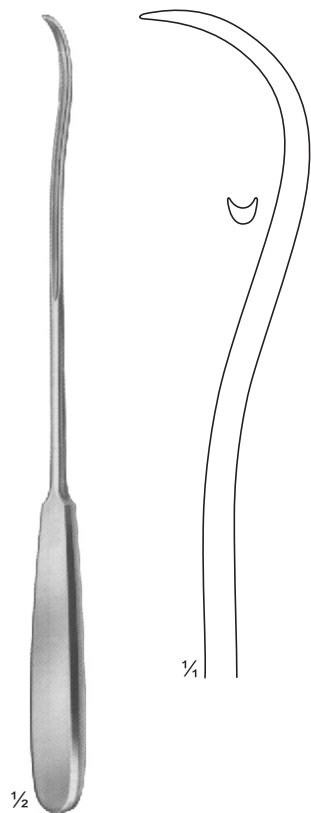

JJ-17-187
280 mm

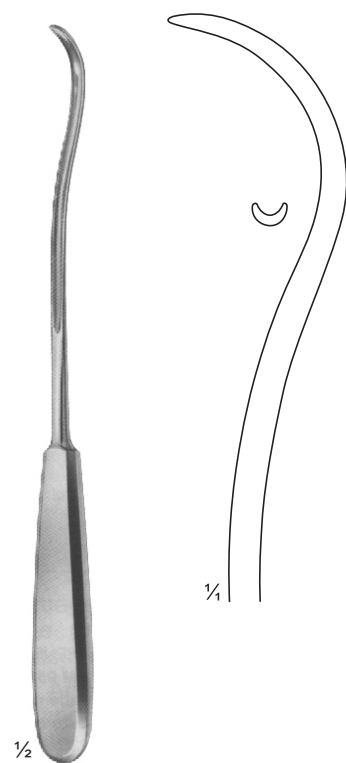

JJ-17-188
KIRSCHNER
255 mm

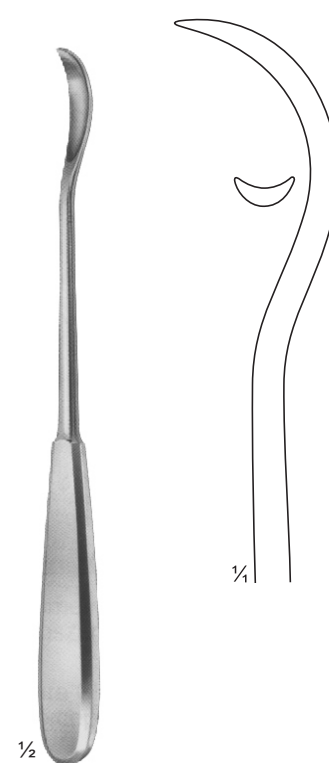

JJ-17-189
BRUNNER
245 mm



JJ-17-190
Ligature Adjuster
230 mm



JJ-17-191
CASPER
Ligature Adjuster
230 mm



JJ-17-192
WIENER MODEL
Suture hook
235 mm

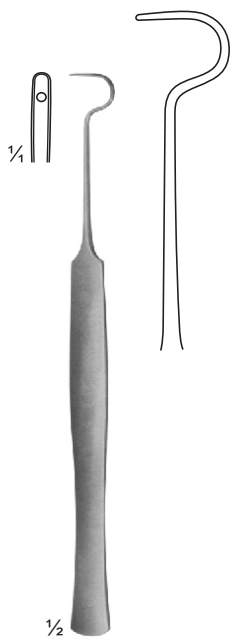

SYME
JJ-17-193
15 cm

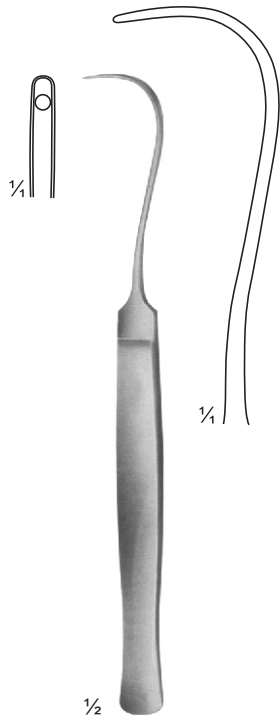

SYME
JJ-17-194
17 cm

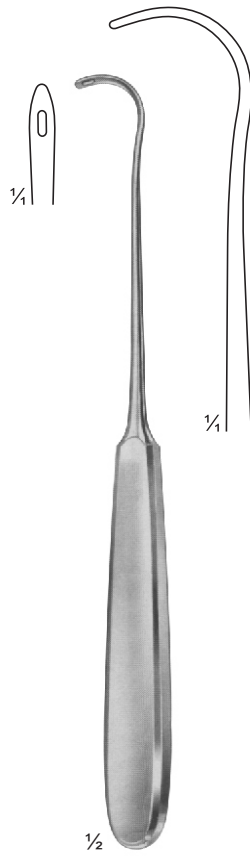

COOPER
JJ-17-195
20.5 cm

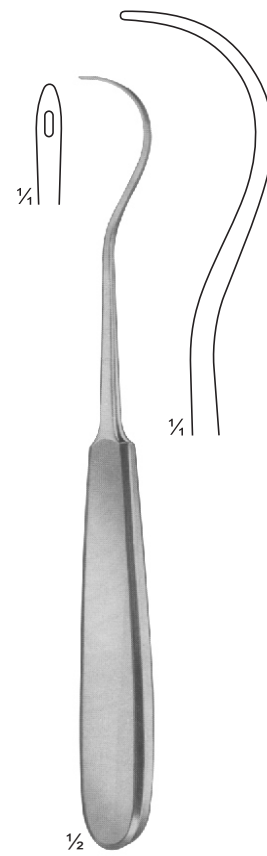

KOCHER
JJ-17-196
20.5 cm



CLAUS VAN EICKEN
Needle for wire suture
JJ-17-197
25 cm

SUTURE INSTRUMENTS - LIGATURE NEEDLES

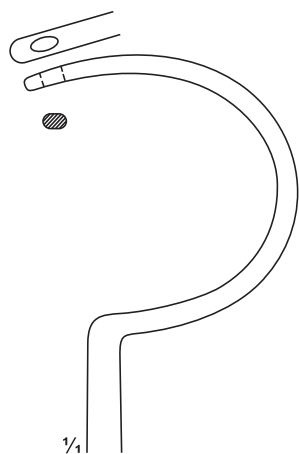

DEMEL
Wire guides
JJ-17-198 - JJ-17-200
JJ-17-198 275 mm
JJ-17-199 285 mm
JJ-17-200 305 mm

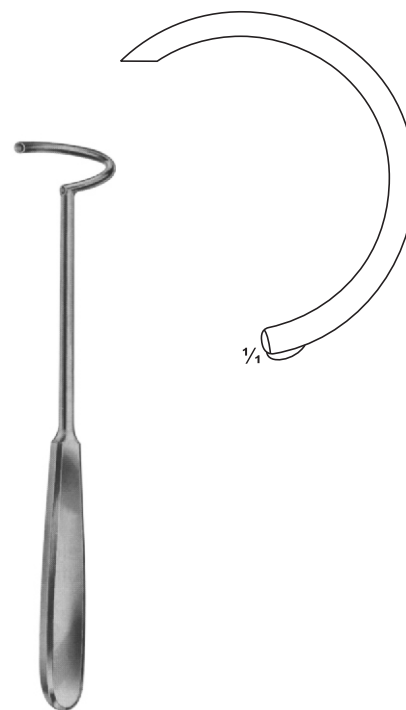

JJ-17-201
225 mm

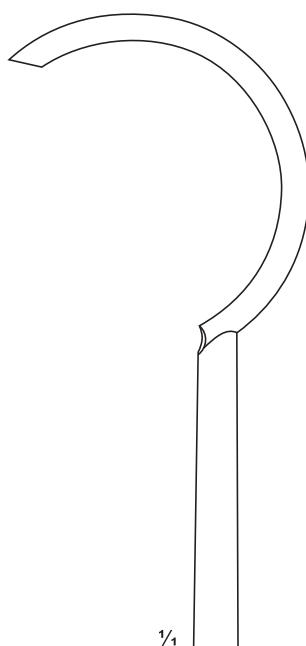

JJ-17-202 - JJ-17-203
JJ-17-202 240 mm
JJ-17-203 270 mm



KALT
JJ-17-204
13.5 cm



DIETRICH
JJ-17-205 - JJ-17-209
JJ-17-205 16 cm
JJ-17-206 18 cm
JJ-17-207 20 cm
JJ-17-208 23 cm
JJ-17-209 26 cm



WEBSTER
JJ-17-210
13 cm



DERF
JJ-17-211
12 cm



HEGAR-BAUMGARTNER
JJ-17-212 - JJ-17-213
JJ-17-212 12.5 cm
JJ-17-213 14 cm

JJ-17-212
12.5 cm

JJ-17-213
14 cm



WEBSTER
JJ-17-214
13 cm

NEEDLE HOLDERS WITH TUNGSTEN CARBIDE INSERTS



HALSEY
JJ-17-215 - JJ-17-216
13 cm



CRILE-WOOD
JJ-17-217 - JJ-17-218

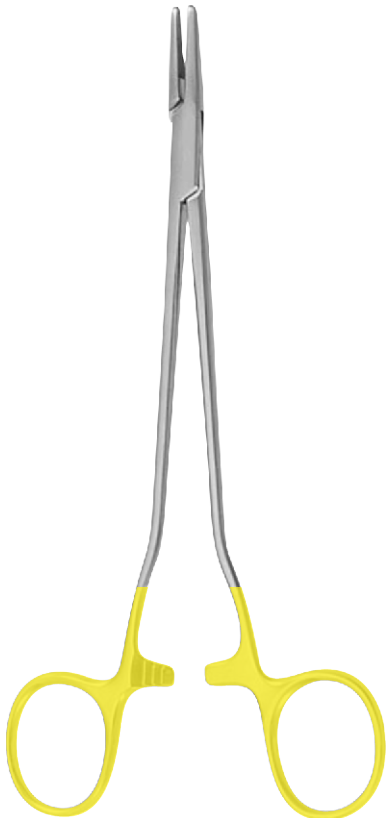
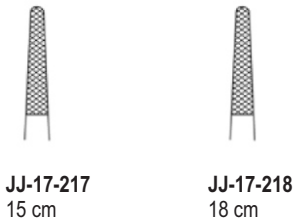

SAROT
JJ-17-219 - JJ-17-221

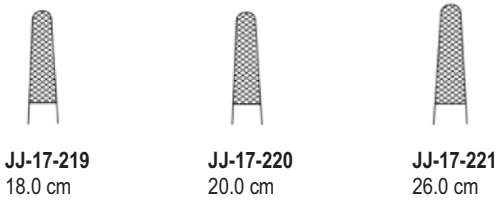



MAYO-HEGAR
JJ-17-222 - JJ-17-227
JJ-17-222 16 cm
JJ-17-223 18 cm
JJ-17-224 20 cm
JJ-17-225 24 cm
JJ-17-226 26 cm
JJ-17-227 30 cm

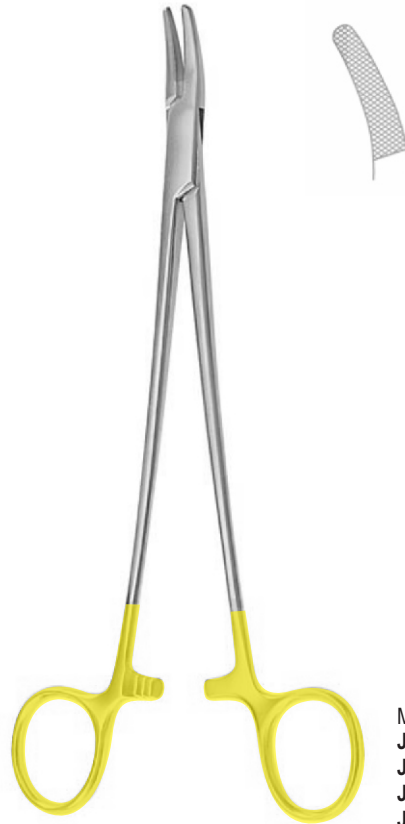

MAYO-HEGAR (HEANEY)
JJ-17-228 - JJ-17-230
JJ-17-228 20 cm
JJ-17-229 24 cm
JJ-17-230 26 cm

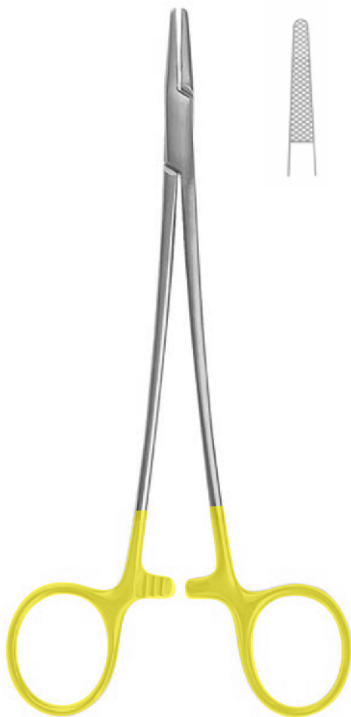

DE BAKEY
JJ-17-231 - JJ-17-236
JJ-17-231 18 cm
JJ-17-232 20 cm
JJ-17-233 23 cm
JJ-17-234 26 cm
JJ-17-235 31 cm
JJ-17-236 37 cm

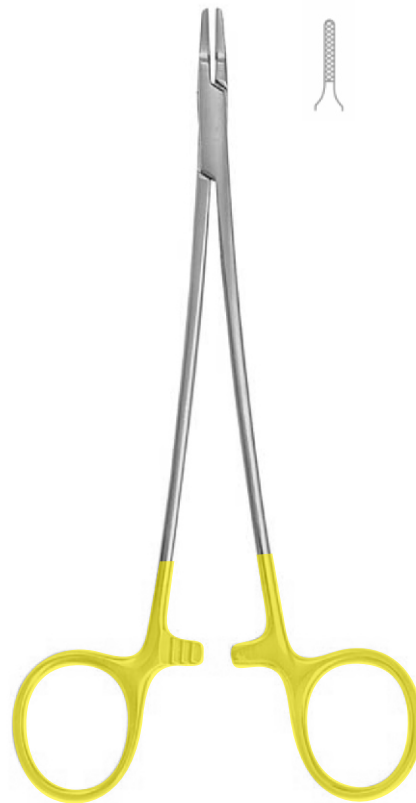

RYDER-VASCULAR
JJ-17-237 - JJ-17-242
JJ-17-237 13 cm
JJ-17-238 15 cm
JJ-17-239 18 cm
JJ-17-240 20 cm
JJ-17-241 23 cm
JJ-17-242 26 cm

NEEDLE HOLDERS WITH TUNGSTEN CARBIDE INSERTS



RYDER
JJ-17-243 - JJ-17-248
 JJ-17-243 13 cm
 JJ-17-244 15 cm
 JJ-17-245 18 cm
 JJ-17-246 20 cm
 JJ-17-247 23 cm
 JJ-17-248 26 cm

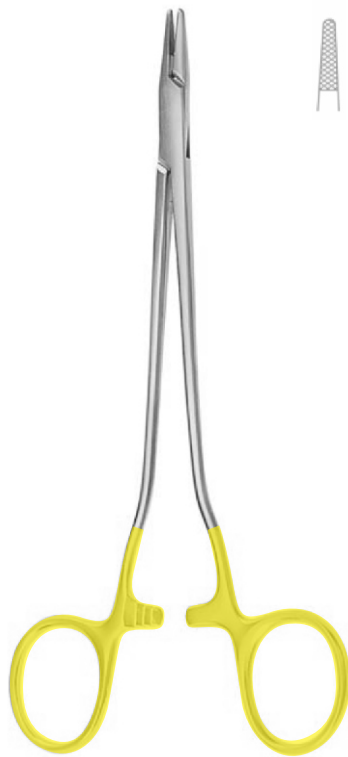

SCHWEDISCHES MODELL
JJ-17-249 - JJ-17-251
 JJ-17-249 15 cm
 JJ-17-250 17 cm
 JJ-17-251 20 cm

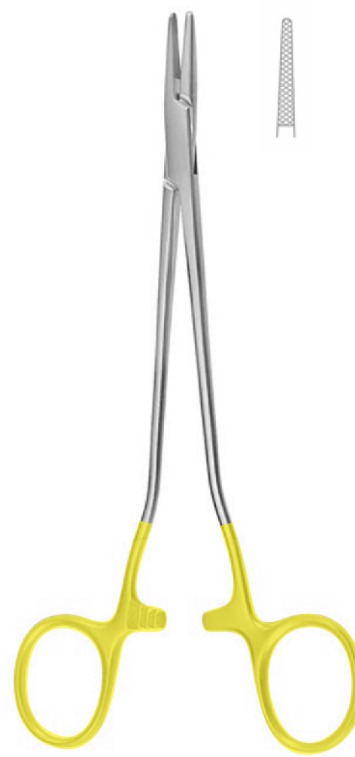

MAYO-HEGAR (HEANEY)
JJ-17-252 - JJ-17-255
 JJ-17-252 14 cm
 JJ-17-253 18 cm
 JJ-17-254 20 cm
 JJ-17-255 23 cm

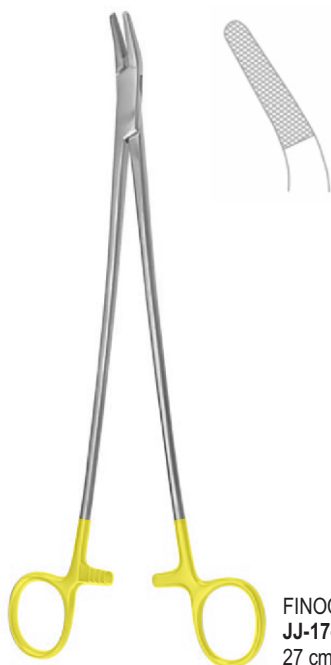

FINOCCHIETTO
JJ-17-256
 27 cm



MASSON
JJ-17-257
 27 cm



WANGENSTEEN
JJ-17-258
 27 cm

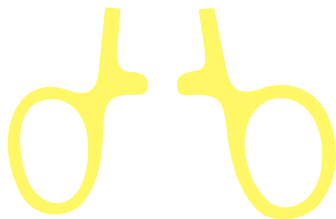

BOZEMANN
JJ-17-259 - JJ-17-261
JJ-17-259 20 cm
JJ-17-260 24 cm
JJ-17-261 26 cm



BERRY STERNAL
JJ-17-262 - JJ-17-263

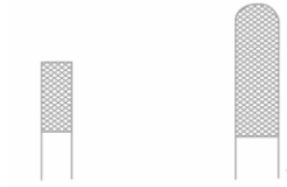

JJ-17-262
FOR STERNUM
SUTURE
15 cm

JJ-17-263
WIRE TWISTER
20 cm



HEGAR
JJ-17-264 - JJ-17-265
JJ-17-264 20 cm
JJ-17-265 24 cm

NEEDLE HOLDERS WITH TUNGSTEN CARBIDE INSERTS



STRATTE
JJ-17-266 - JJ-17-267
JJ-17-266 22 cm
JJ-17-267 23 cm



GILLIES
JJ-17-268
16 cm



OLSEN-HEGAR
JJ-17-269 - JJ-17-271
JJ-17-269 14 cm
JJ-17-270 17 cm
JJ-17-271 18 cm



TOENNIS
JJ-17-272
18 cm



LICHTENBERG
JJ-17-273 - JJ-17-274
JJ-17-273 17 cm
JJ-17-274 20 cm



MATHIEU-KOCHER
JJ-17-275 - JJ-17-277
JJ-17-275 14 cm
JJ-17-276 17 cm
JJ-17-277 20 cm



MATHIEU
JJ-17-278 - JJ-17-280
JJ-17-278 14 cm
JJ-17-279 17 cm
JJ-17-280 20 cm



MATHIEU
JJ-17-281 - JJ-17-283
JJ-17-281 14 cm
JJ-17-282 17 cm
JJ-17-283 20 cm



ZWEIFEL
JJ-17-284 - JJ-17-285
JJ-17-284 20 cm
JJ-17-285 23 cm



LANGENBECK
JJ-17-286 - JJ-17-288
JJ-17-286 18 cm
JJ-17-287 20 cm
JJ-17-288 23 cm

NEEDLE HOLDERS WITH TUNGSTEN CARBIDE INSERTS



CASTROVIEJO
JJ-17-289 - JJ-17-292
14.5 cm



JJ-17-289



JJ-17-290



JJ-17-291



JJ-17-292



CASTROVIEJO
JJ-17-293 - JJ-17-296
18 cm



JJ-17-293



JJ-17-294



JJ-17-295



JJ-17-296



BARRAQUER
JJ-17-297 - JJ-17-300
14.5 cm



JJ-17-297



JJ-17-298



JJ-17-299



JJ-17-300



HEPP SCHEIDEL
JJ-17-301
18 cm



Page 396-406

- Gall Bladder, Liver and Spleen Instruments
- Genito Urinary Instruments

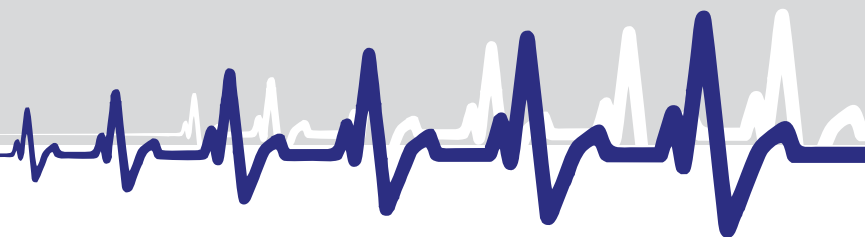

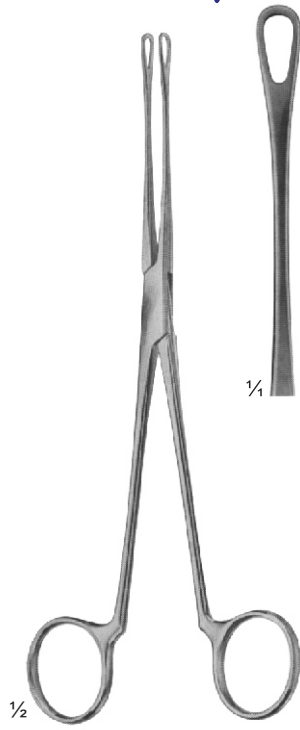

JJ-18-101
BLAKE
205 mm

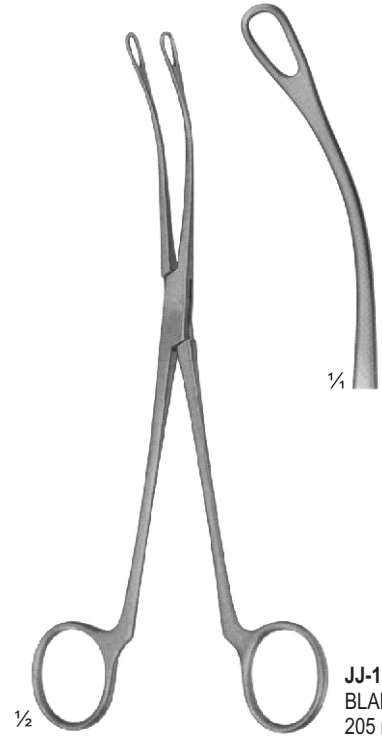

JJ-18-102
BLAKE
205 mm

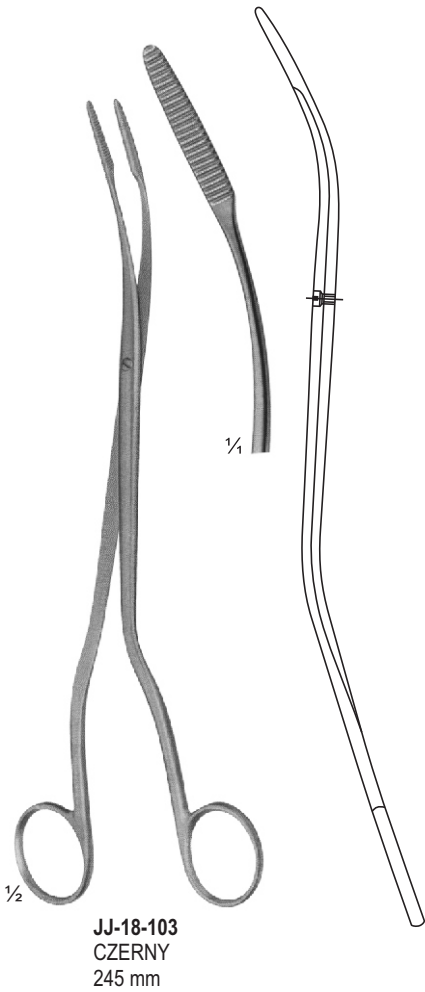

JJ-18-103
CZERNY
245 mm

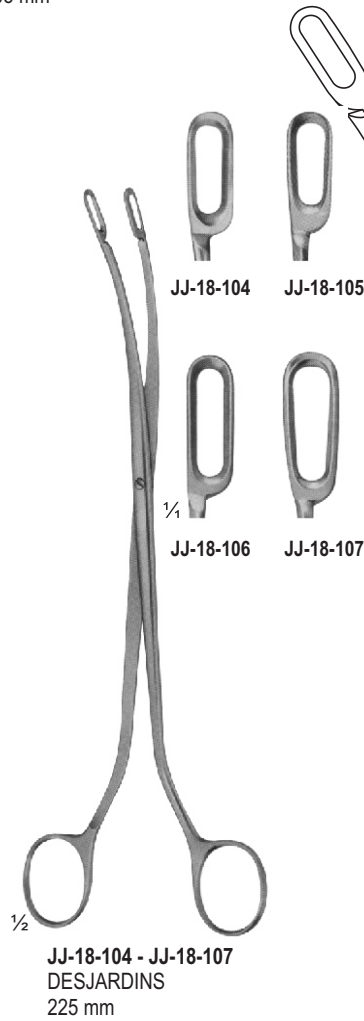

JJ-18-104 - JJ-18-107
DESJARDINS
225 mm

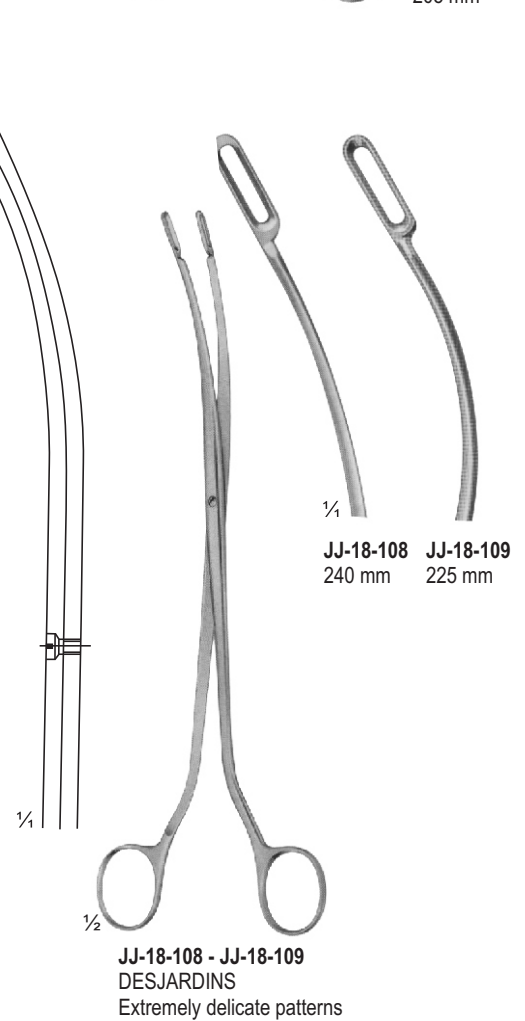

JJ-18-108 - JJ-18-109
DESJARDINS
Extremely delicate patterns

KIDNEY STONE FORCEPS



JJ-18-110

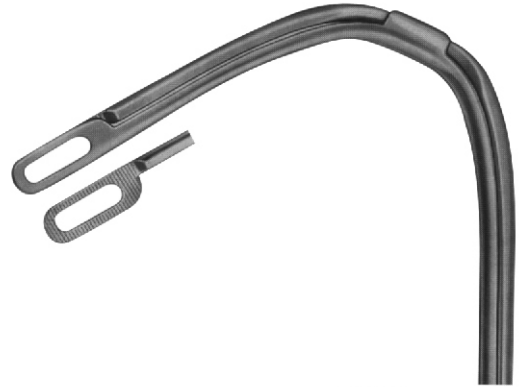

JJ-18-114



JJ-18-111



JJ-18-115



1/2

JJ-18-110 - JJ-18-113
RANDALL
225 mm



JJ-18-112



1/4
JJ-18-116



1/4
JJ-18-113

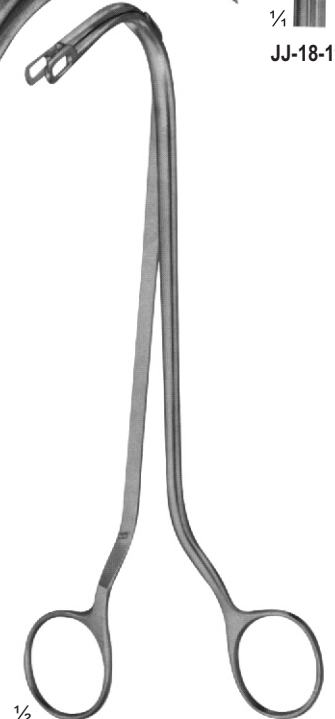

1/2

JJ-18-114 - JJ-18-116
RANDALL
190 mm

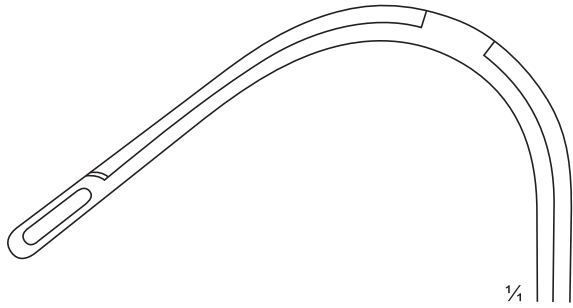

Fig. 1
JJ-18-117
230 mm

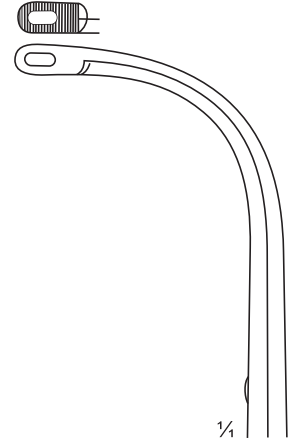

Fig. 1
JJ-18-119
160 mm

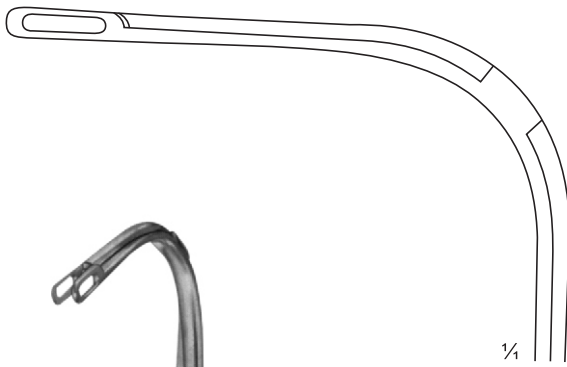

Fig. 2
JJ-18-118
240 mm

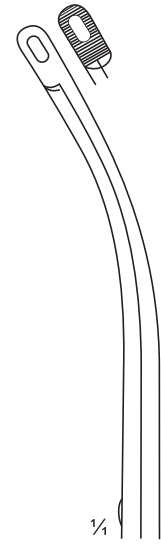
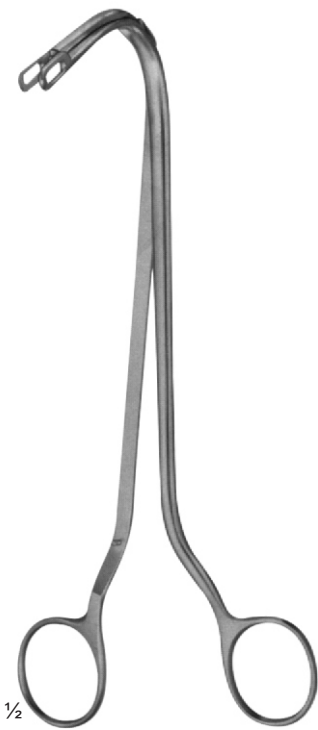
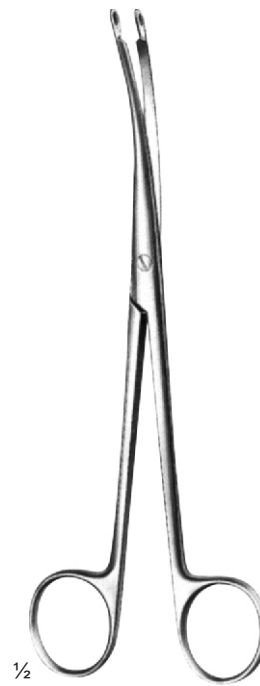

Fig. 1
JJ-18-120
170 mm



1/2

RANDALL
JJ-18-117 - JJ-18-118



1/2

HEIMING
JJ-18-119 - JJ-18-120

NEPHROSTOMY FORCEPS



ELSÄSSER
JJ-18-121 - JJ-18-122
210 mm

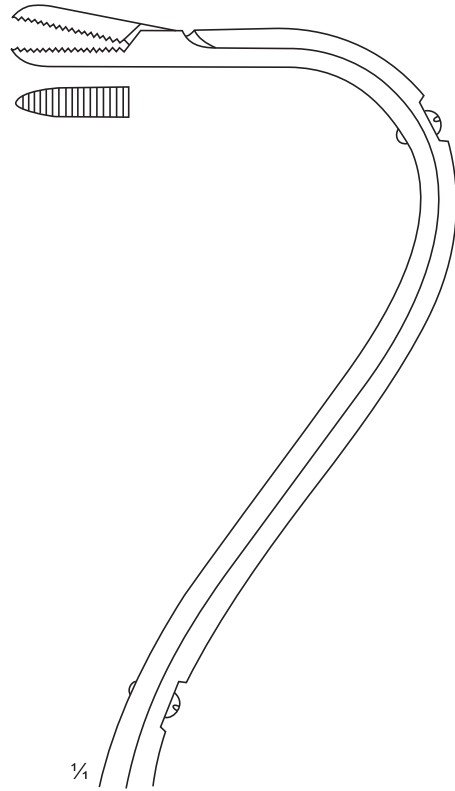

Fig. 1
JJ-18-121

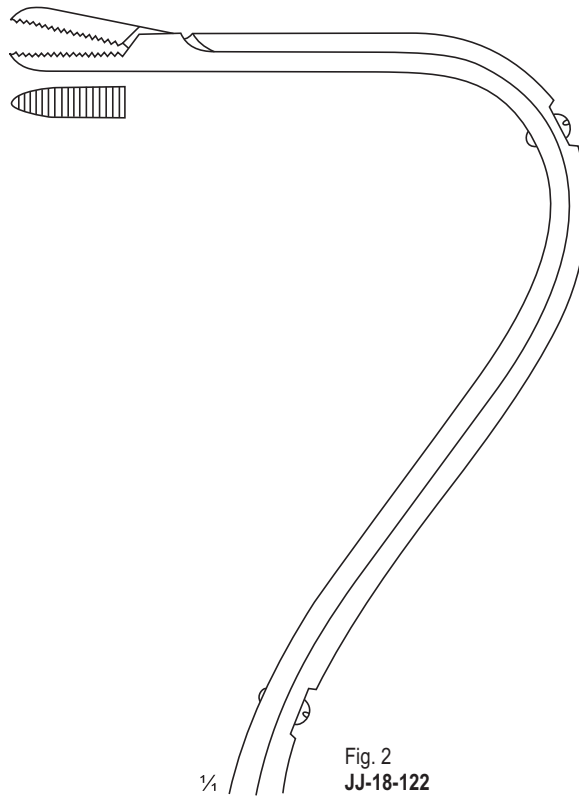
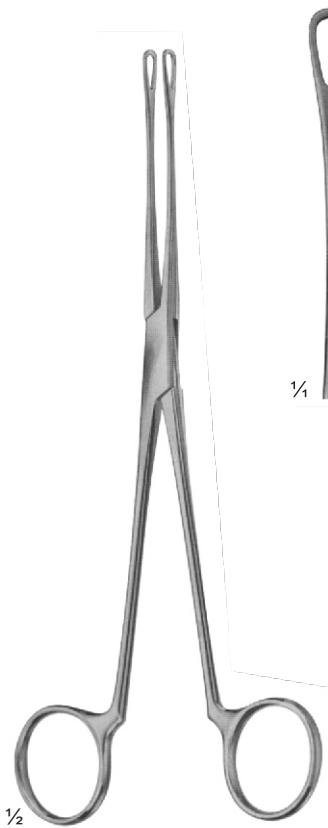
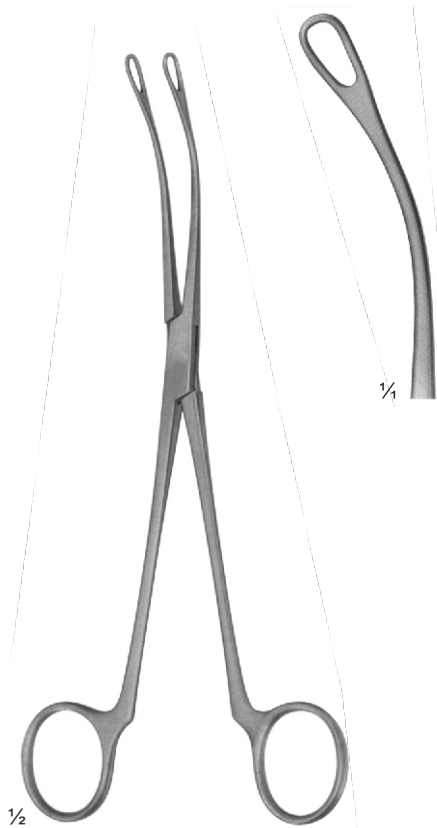

Fig. 2
JJ-18-122



BLAKE
JJ-18-123
205 mm



BLAKE
JJ-18-124
205 mm



MAYO-BLAKE
JJ-18-125
210 mm



MAYO-BLAKE
JJ-18-126
210 mm

GALL STONE, CAPSULE FORCEPS

ATRAUMA

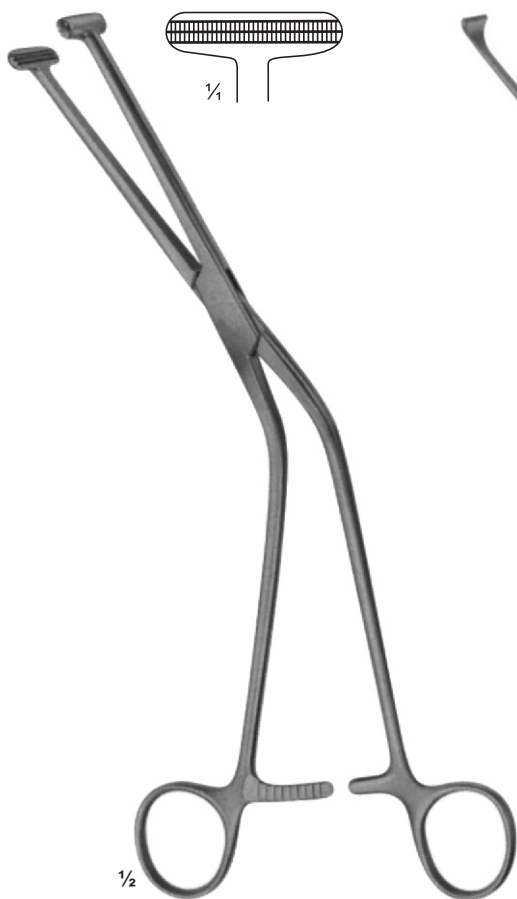

MILLIN
Lobe grasping forceps
JJ-18-127
235 mm

ATRAUMA

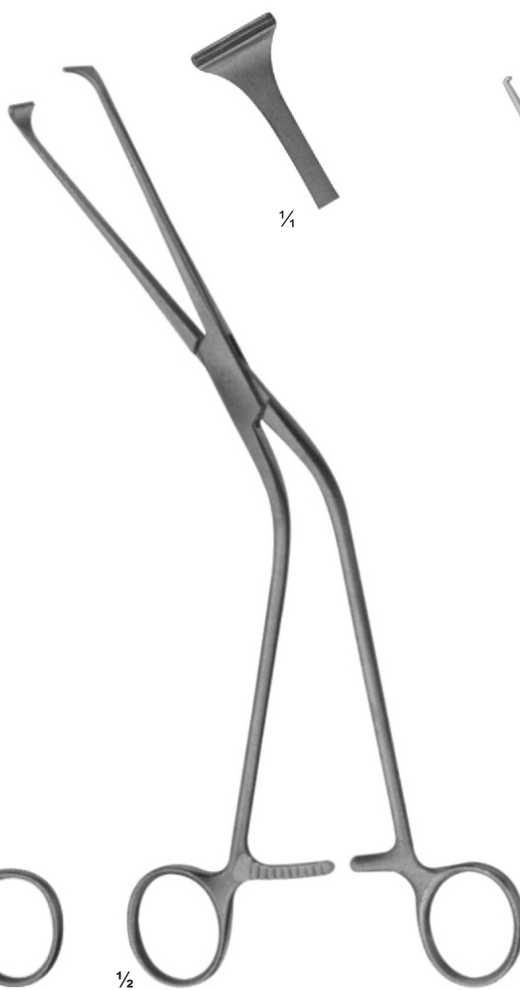

MILLIN
Lobe grasping forceps
JJ-18-128
245 mm



MILLIN
Ligature holding forceps
JJ-18-129
245 mm



LEGUEU
JJ-18-130
270 mm



KOCHER
JJ-18-131
260 mm



KOCHER
JJ-18-132
260 mm

PROSTATIC RETRACTORS

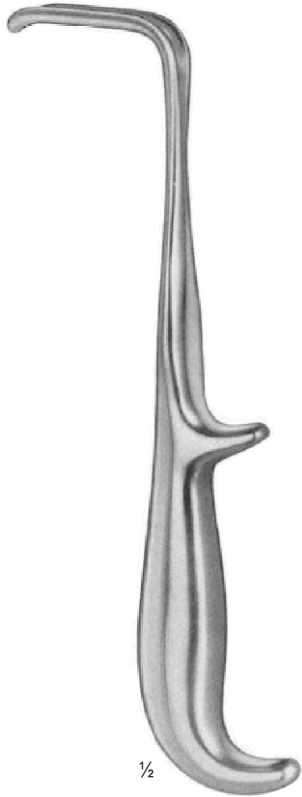

1/2

YOUNG
JJ-18-133
210 mm



1/2

YOUNG
JJ-18-134
220 mm



1/2

YOUNG
JJ-18-135
210 mm



1/2

YOUNG
JJ-18-136
220 mm

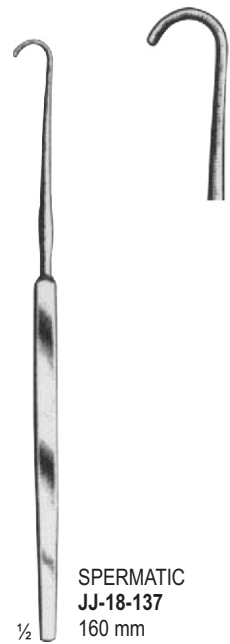

1/2

SPERMATIC
JJ-18-137
160 mm

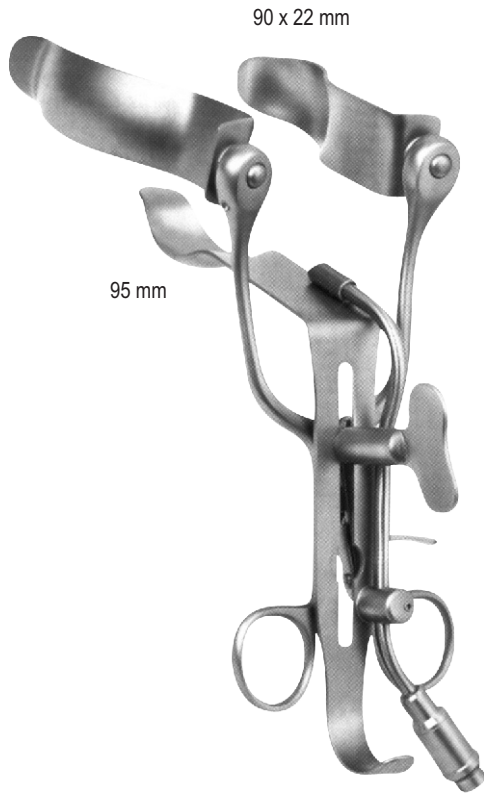

90 x 22 mm

95 mm

ALAN-PARKS
JJ-18-138
150 mm

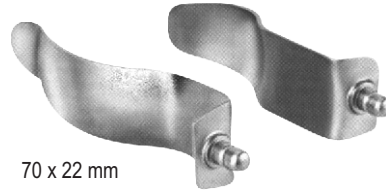

70 x 22 mm



FIBER OPTIC
JJ-18-139

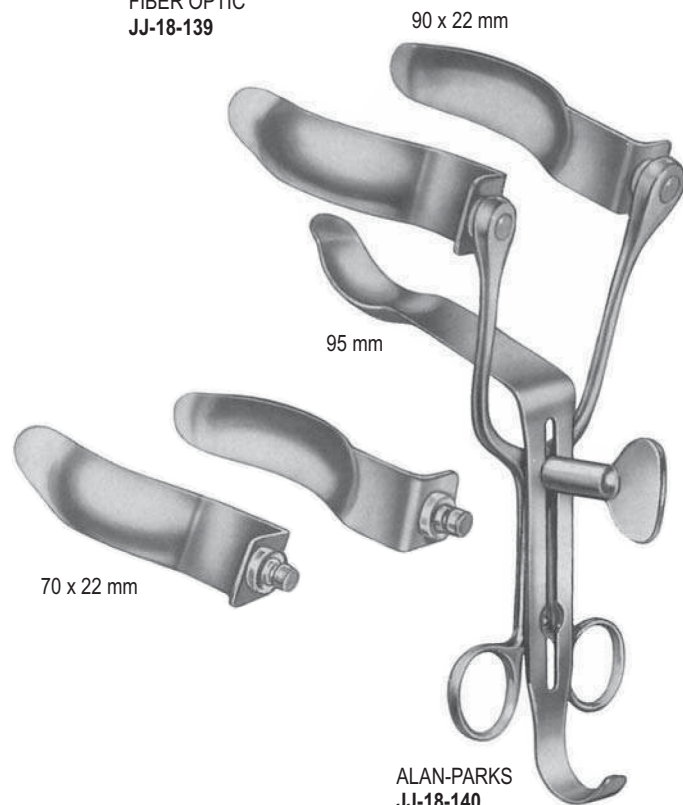

90 x 22 mm

95 mm

70 x 22 mm

ALAN-PARKS
JJ-18-140
150 mm

GALL DUCT PROBES

Ø 3.5 mm



JJ-18-141
HAJEK
Irrigating cannula,
silver
165 mm

Ø 5 mm



JJ-18-142
MOYNIHAN
Gall duct probes,
malleable
365 mm

Ø 5 mm



JJ-18-143
MAYO
Gall duct probes,
malleable
330 mm

Ø 3.5 mm

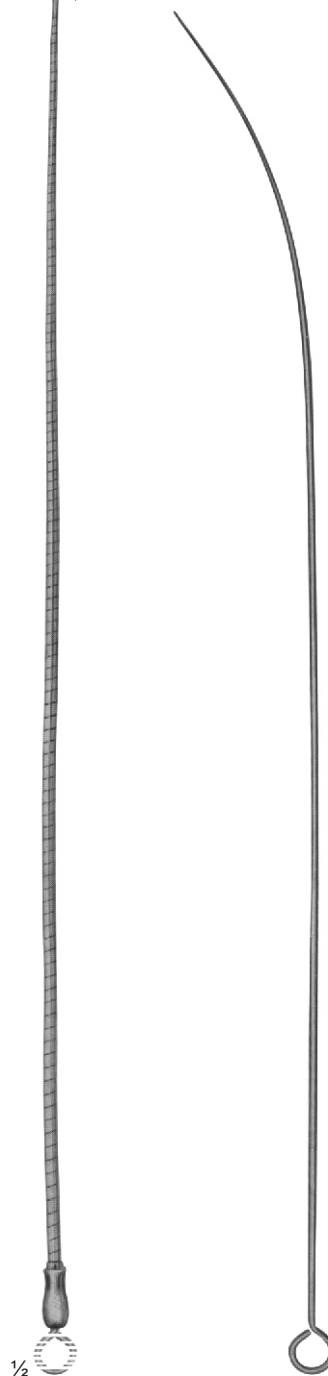

JJ-18-144
OCHSNER
Gall duct probes, flexible
400 mm

Ø 3.8 mm



JJ-18-145



JJ-18-146



JJ-18-147

JJ-18-145 - JJ-18-147
DESJARDINS
Gall duct probes,
flexible
285 mm



- JJ-18-148 8
- JJ-18-149 9
- JJ-18-150 10
- JJ-18-151 11
- JJ-18-152 12
- JJ-18-153 13
- JJ-18-154 14
- JJ-18-155 15
- JJ-18-156 16
- JJ-18-157 17
- JJ-18-158 18
- JJ-18-159 19
- JJ-18-160 20
- JJ-18-161 21
- JJ-18-162 22
- JJ-18-163 23
- JJ-18-164 24
- JJ-18-165 25
- JJ-18-166 26
- JJ-18-167 27
- JJ-18-168 28
- JJ-18-169 29
- JJ-18-170 30

JJ-18-148 - JJ-18-170
DITTEL
Metall bougies and
dilating sounds, stiff
345 mm



JJ-18-171 - JJ-18-183
BAKES
Common bile duct
dilators, malleable
315 mm, 320 mm

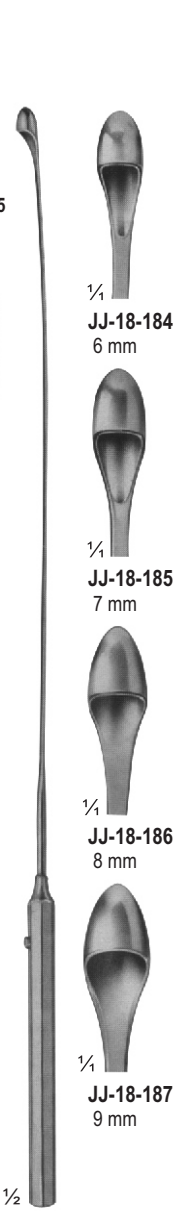
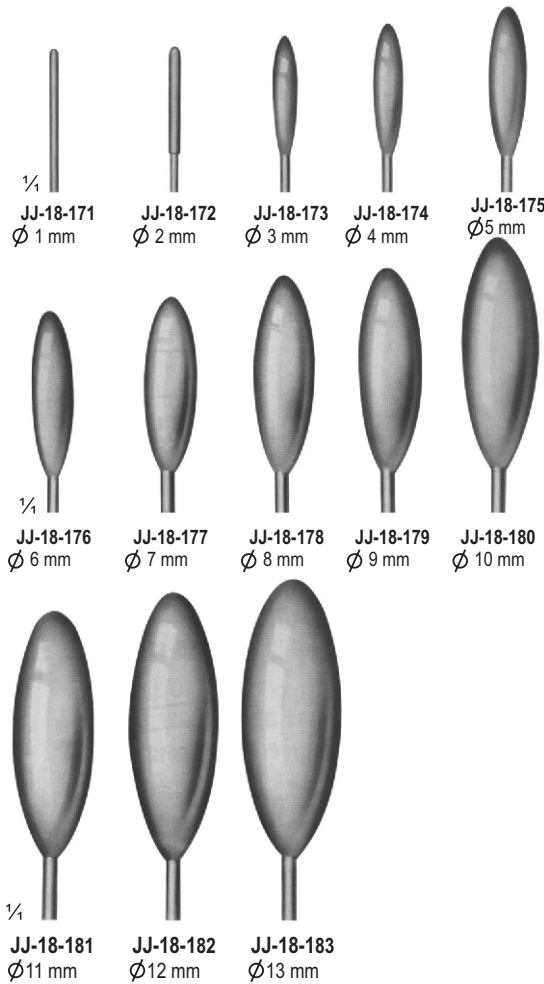

JJ-18-184 - JJ-18-187
DESJARDINS
Probes and catch
with flexible shaft
300 mm

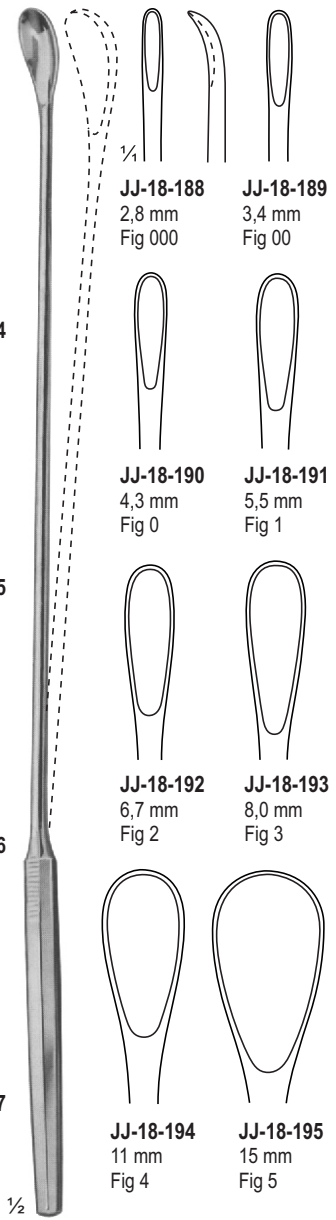

JJ-18-188 - JJ-18-195
LUER-KORTE modif
with malleable shaft
310 mm

Page 407-463

- Mallets
- Tempers, Chisels, Gouges
- Bone Holding Forceps
- Rongeurs
- Bone Cutting Forceps
- Meniscus Instruments
- Wire Extension
- Hand Drills, Awls
- Reamers
- Bone Biopsy Instruments
- Finger Nail Instruments

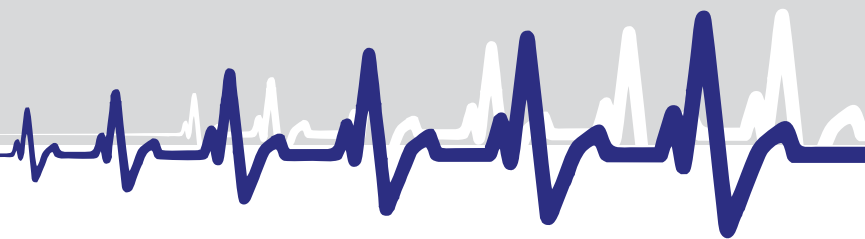

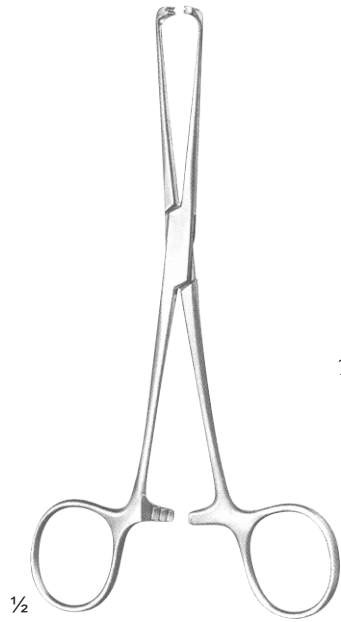

STEINMANN
JJ-19-101
160 mm

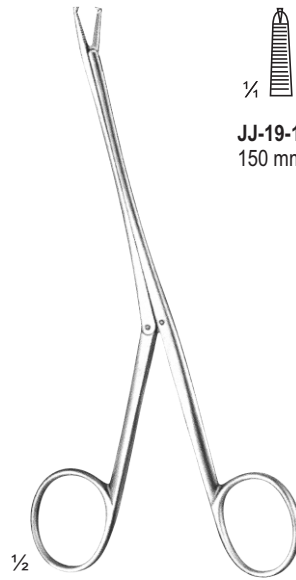
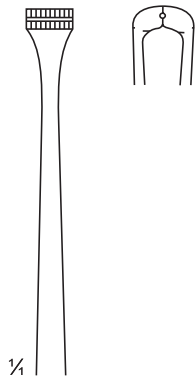

BRAND
JJ-19-102 - JJ-19-104

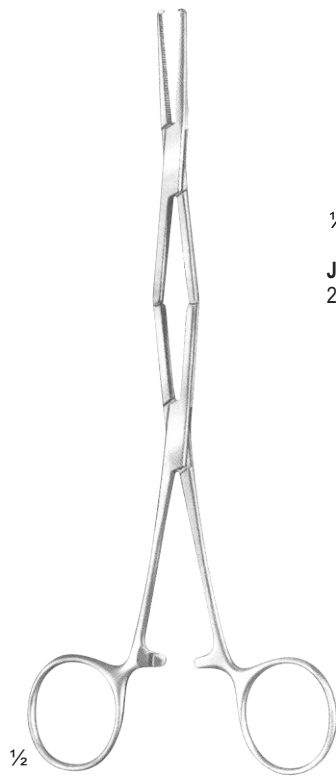
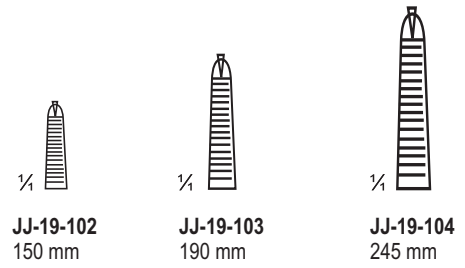

JJ-19-105 - JJ-19-106

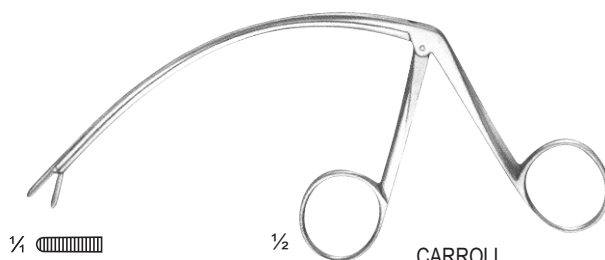
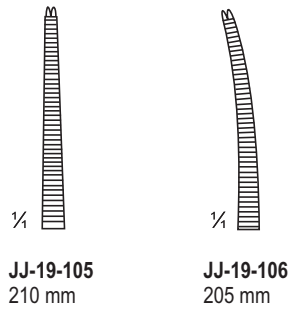

CARROLL
JJ-19-107
115 mm

TENDON HOLDING FORCEPS, TENDON INTERLACING FORCEPS

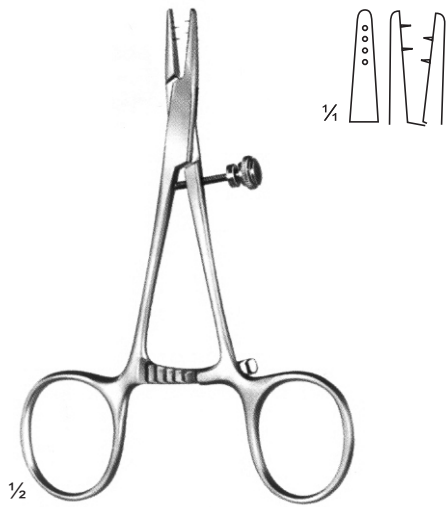

JJ-19-108
115 mm

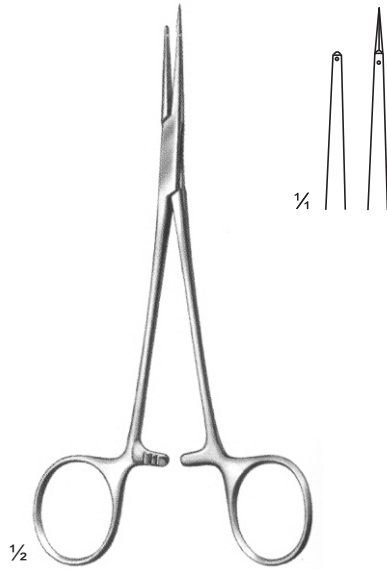

JJ-19-109
150 mm



KLEINERT-KUTZ
JJ-19-110
210 mm
Shaft Length
140 mm

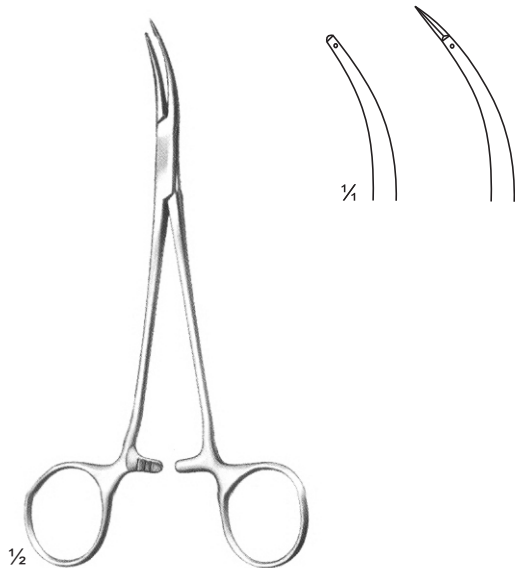

JJ-19-111
150 mm

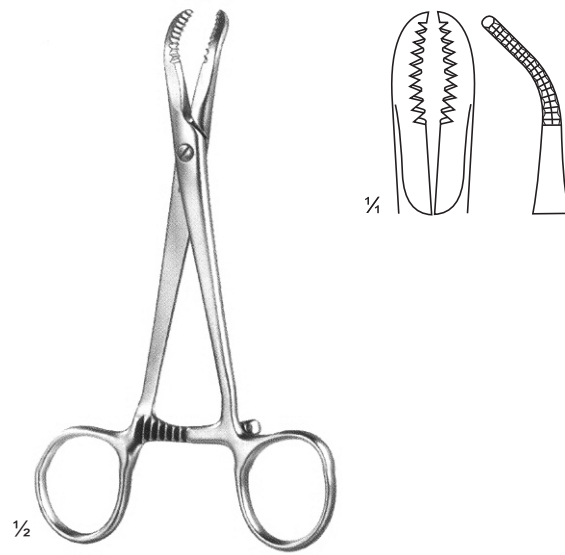

JJ-19-112
145 mm
Bone Holding
Forceps



Repositioning forceps,
for small fragments
JJ-19-113
135 mm

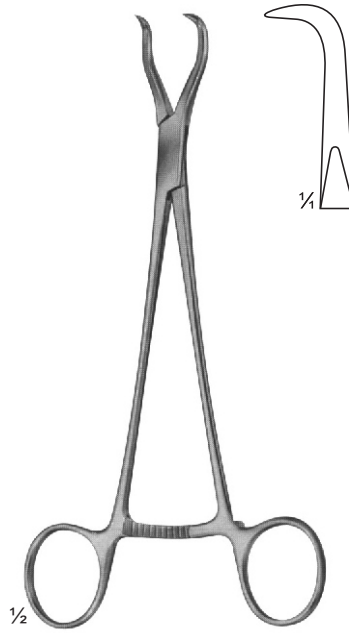

HAASE
Repositioning forceps,
for mandibular
fractures
JJ-19-114
165 mm

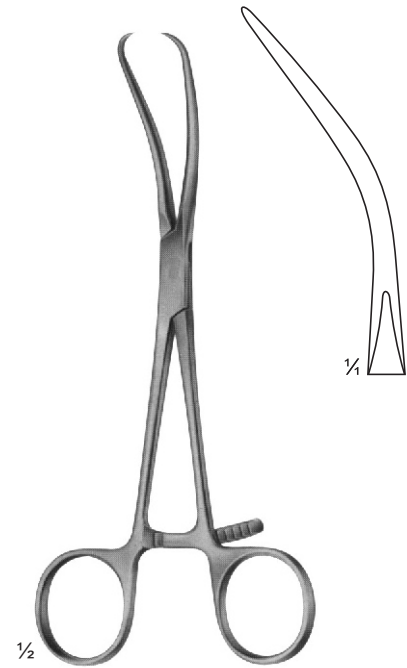

REILL
Repositioning forceps,
JJ-19-115
170 mm

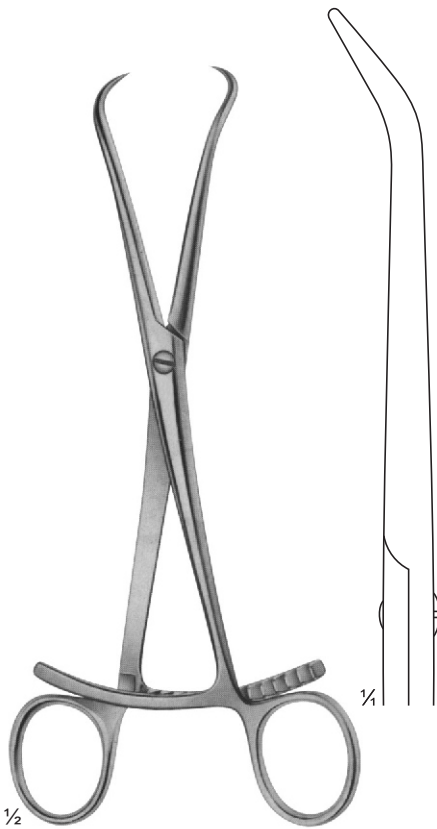

Repositioning forceps
JJ-19-116
205 mm

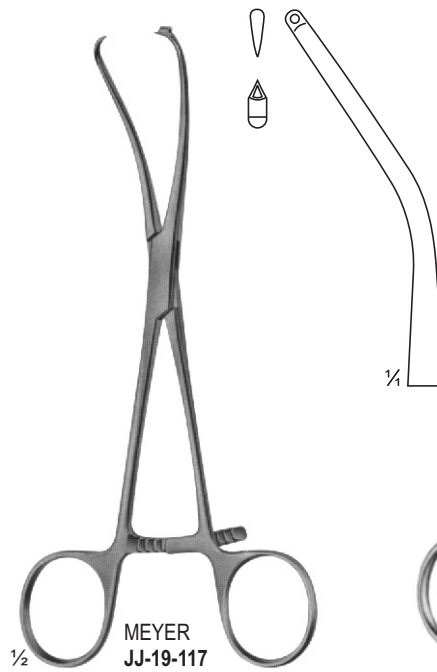

MEYER
JJ-19-117
Repositioning forceps
for fingers, with drill
guide for KIRSCHNER
wires up to diam. 1.0 mm
17 cm

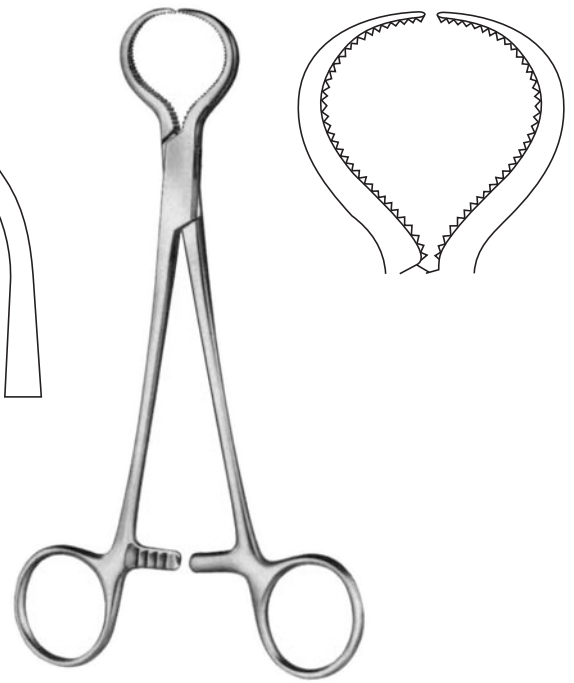

LEWIN
JJ-19-118
180 mm

REPOSITIONING, BONE HOLDING FORCEPS



PATELLA FORCEPS
JJ-19-119
185 mm

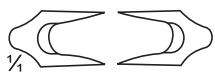

Forceps with
ratchet fixation
JJ-19-120
140 mm



JJ-19-121
120 mm



SETTER
JJ-19-122
135 mm

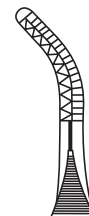

SETTER
JJ-19-123
170 mm



SETTER
JJ-19-124
235 mm

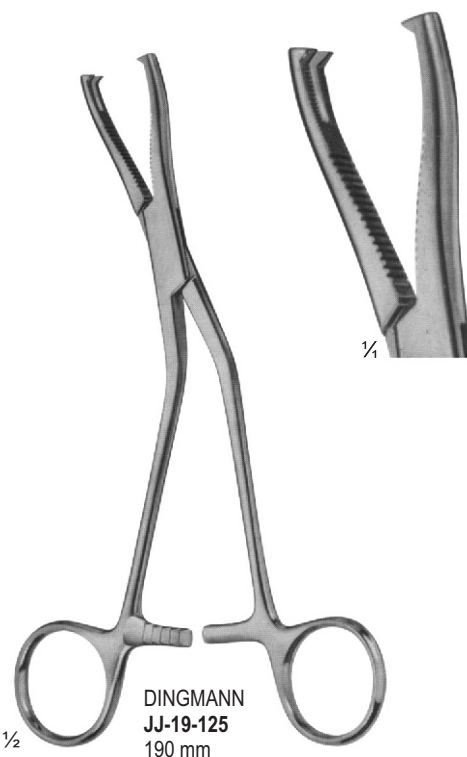

DINGMANN
JJ-19-125
190 mm



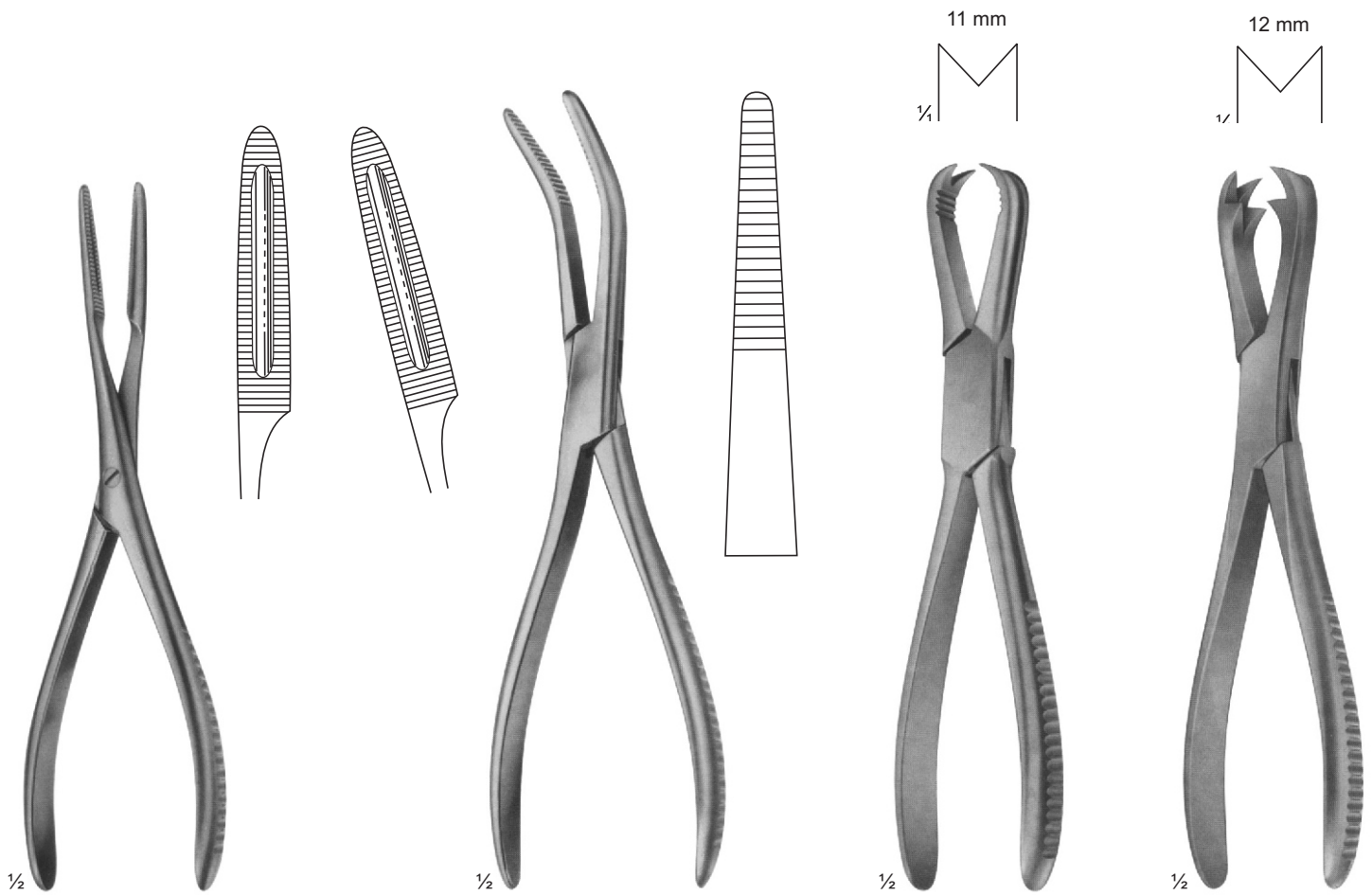

Sequestrum
forceps
JJ-19-126
200 mm

VAN BUREN
Sequestrum
forceps
JJ-19-127
230 mm

LANGENBECK
Sequestrum
forceps
JJ-19-128
205 mm

FERGUSSON
JJ-19-129
205 mm

BONE HOLDING, REPOSITIONING FORCEPS

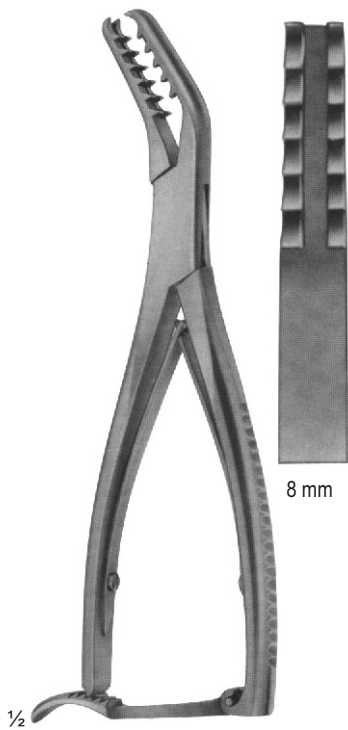

SEM B
JJ-19-130
190 mm

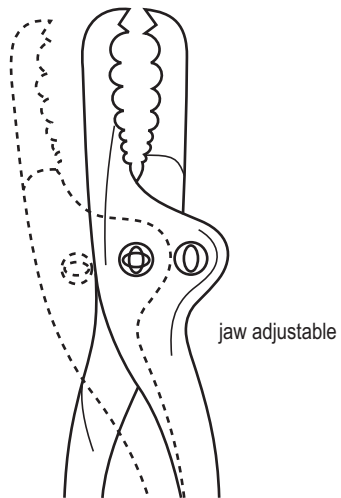
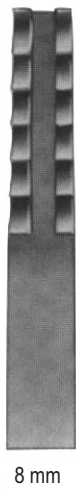

SEM B
JJ-19-131
195 mm

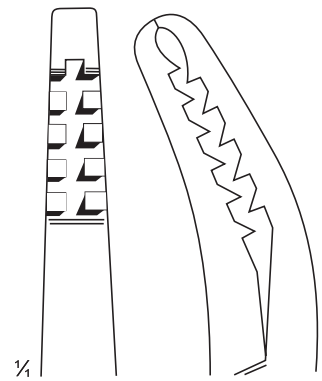

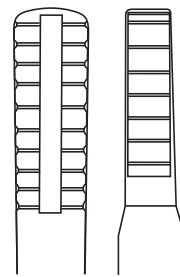
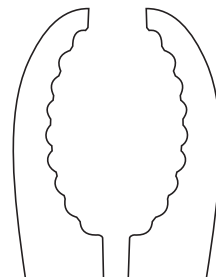
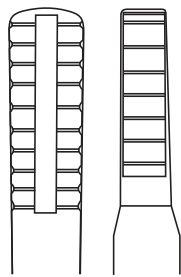
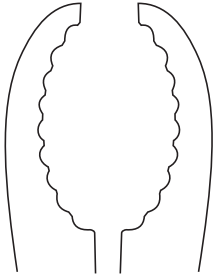

1/2

ULRICH
JJ-19-132 - JJ-19-134
With thread Fixation

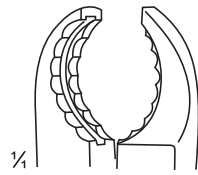

1/4

JJ-19-132
230 mm

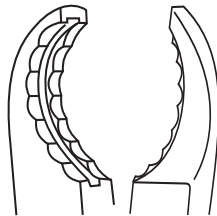

JJ-19-133
250 mm

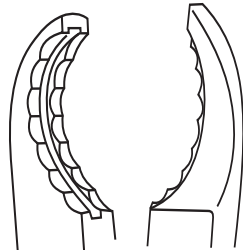

JJ-19-134
280 mm



1/2

ULRICH
JJ-19-135 - JJ-19-137
With thread Fixation

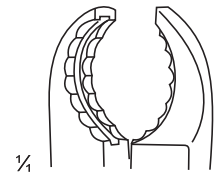

1/4

JJ-19-135
230 mm

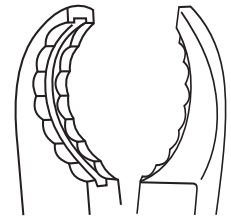

JJ-19-136
250 mm

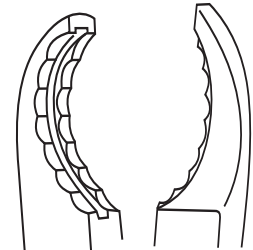

JJ-19-137
270 mm

BONE HOLDING FORCEPS



**FARABEUF
JJ-19-138
230 mm**



**FARABEUF
JJ-19-139
255 mm**



**FARABEUF-LAMBOTTE
JJ-19-140
255 mm**

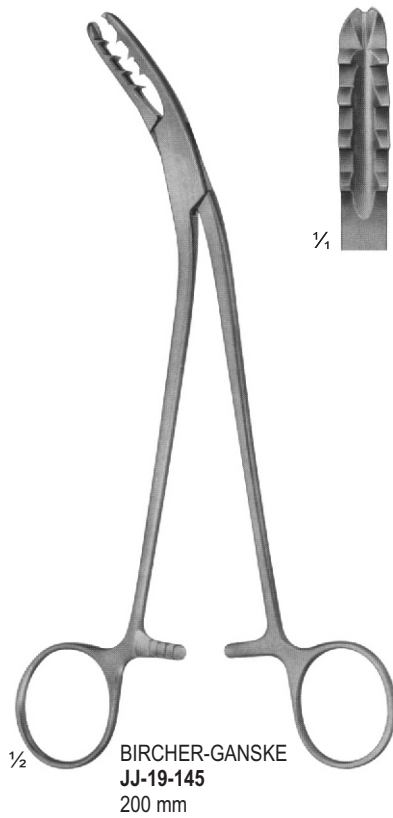
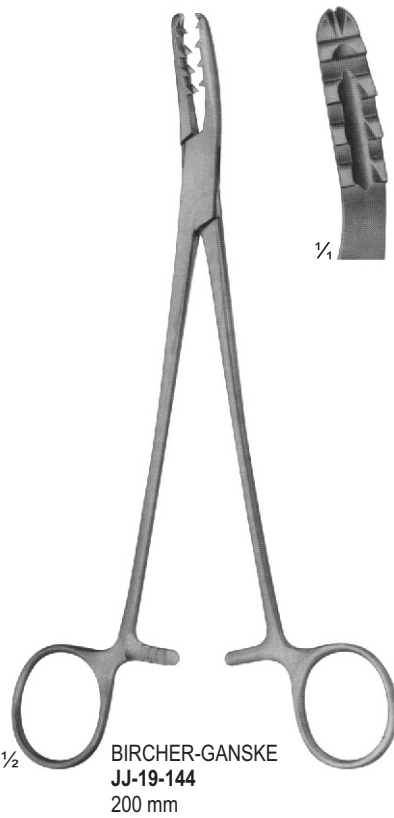
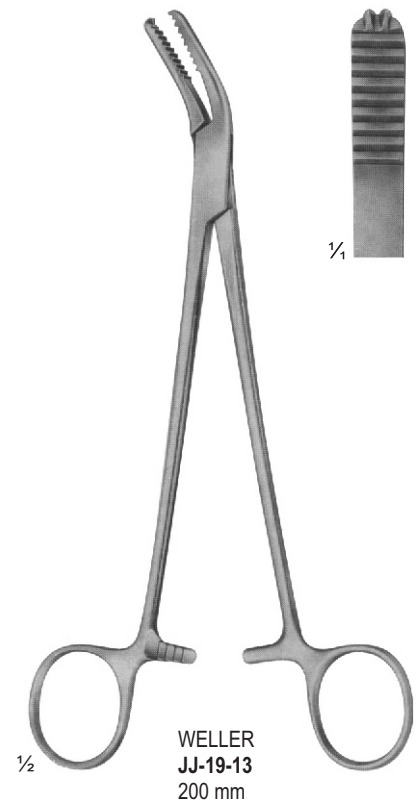
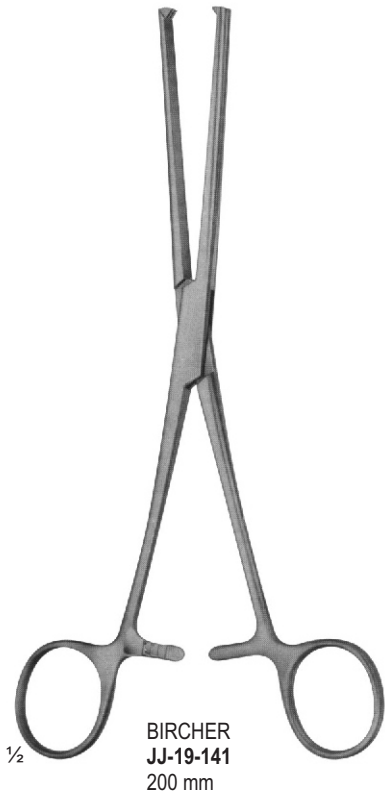

MALLETS

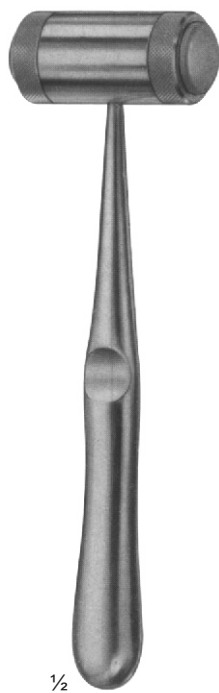

∅ 20 mm

1/2

JJ-19-147
MEAD
185 g
with interchangeable
plastic disks
190 mm
pair of spare disks

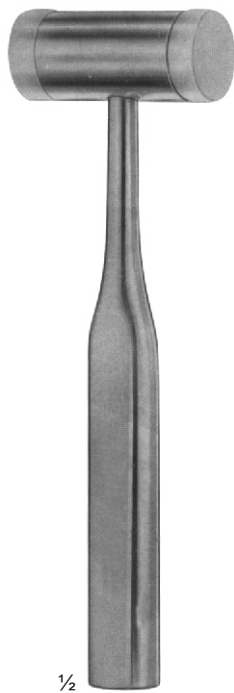

1/2

JJ-19-148
140 g
with interchangeable
plastic disks
185 mm
JJ-19-149
pair of spare disks



∅ 25 mm

1/2

JJ-19-150
COTTLE
140 g
1 Seite convex
1 Side convex
185 mm



∅ 22 mm

1/2

JJ-19-151
165 g
lead filled head
190 mm

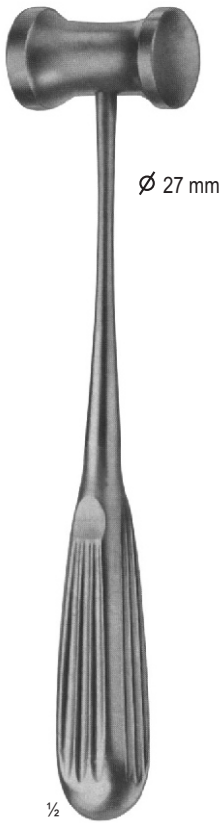

HAJEK
140 g
JJ-19-152
215 mm



ST-053
215 g
with interchangeable
plastic disks
245 mm
ST-054
pair of spare disks

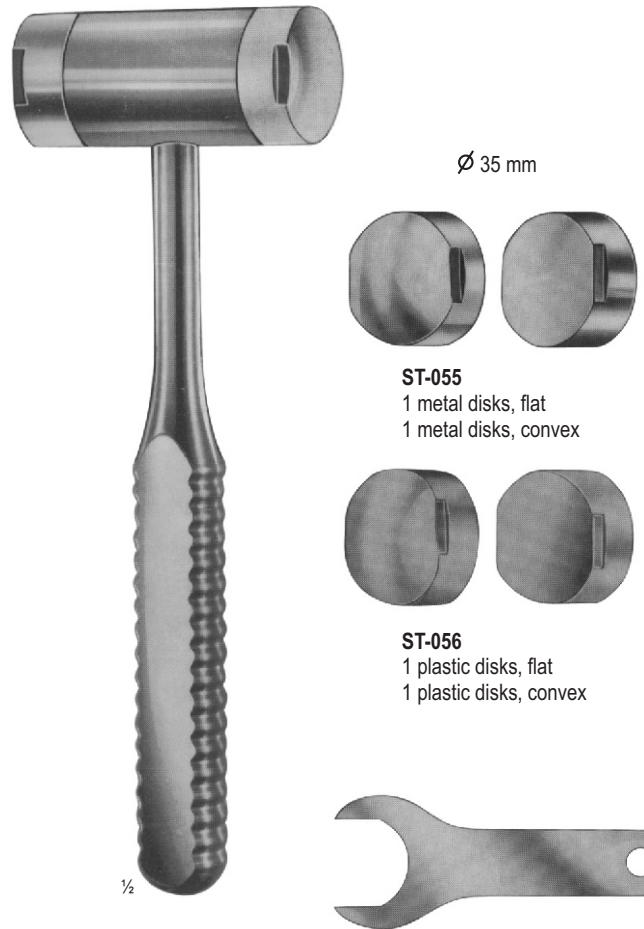

WAGNER
complete with:
1 pair of metal disks and
1 pair of plastic disks and
1 wrench 566
ST-055 - ST-057
235 mm

Wrench
ST-057

Mallet without disks 130 g

MALLETS



BERGMANN
JJ-19-158
245 mm

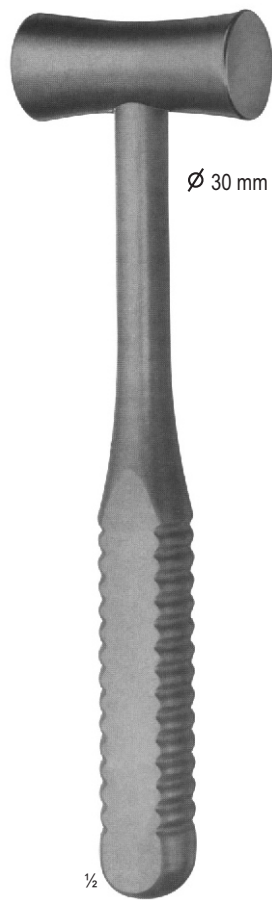

BERGMANN
JJ-19-159
235 mm



OMBREDANNE
JJ-19-160
240 mm

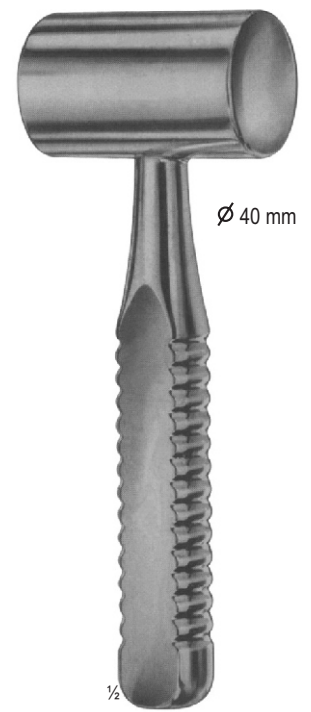

HEATH
copper filled head
700 g
JJ-19-161
185 mm



WILLIGER
JJ-19-162 - JJ-19-164
Lead Filled

JJ-19-162	
Weight	Head
275 g	Ø 26 mm
JJ-19-163	
Weight	Head
320 g	Ø 28 mm
JJ-19-164	
Weight	Head
340 g	Ø 30 mm



DOYEN
JJ-19-165 - JJ-19-167

JJ-19-165	
Weight	Head
120 g	Ø 25 mm
JJ-19-166	
Weight	Head
180 g	Ø 30 mm
JJ-19-167	
Weight	Head
260 g	Ø 35 mm

MALLETS

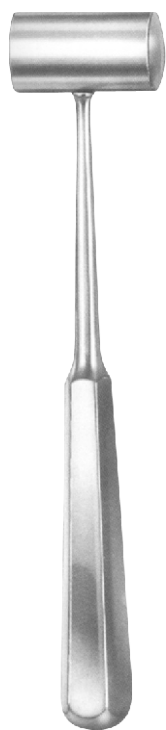

1/2

PARTSCH
JJ-19-168
With Hollow Handle
190 mm

Weight Head
175 g Ø27 mm



VIKERS
JJ-19-169
190 mm

Weight Head
185 g Ø25 mm



HERBERT
JJ-19-170
For Ulna Head Prosthesis
190 mm

Weight Head
215 g Ø25 mm

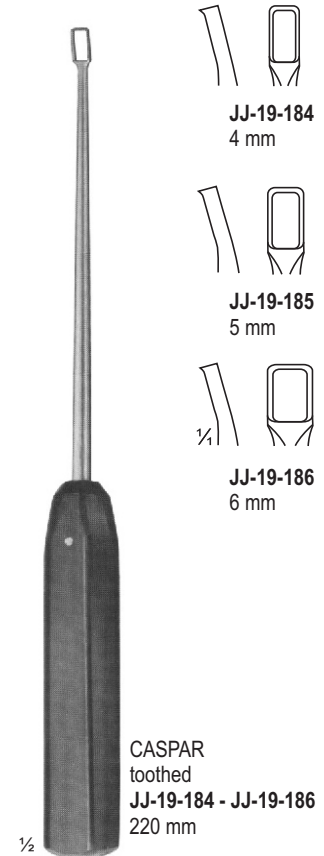
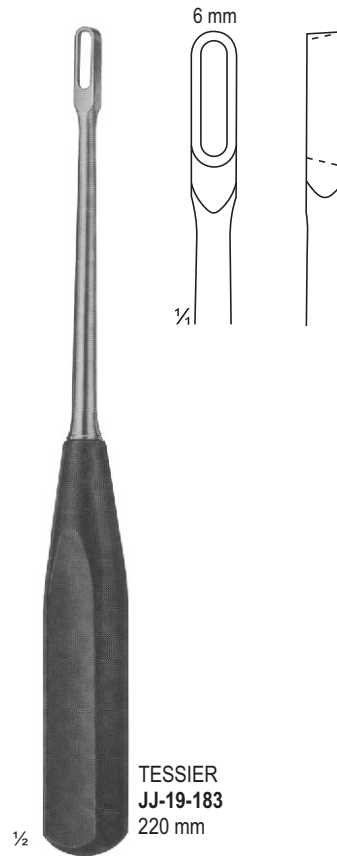
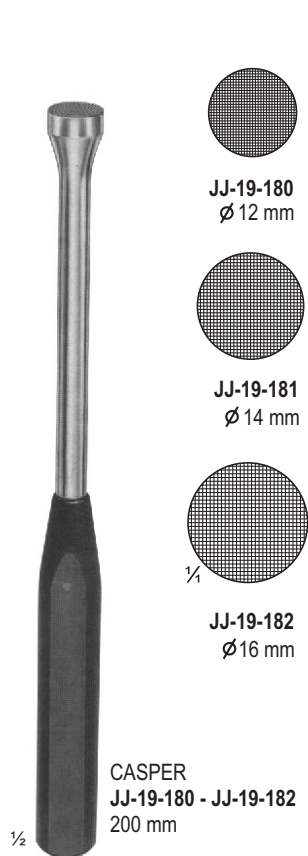
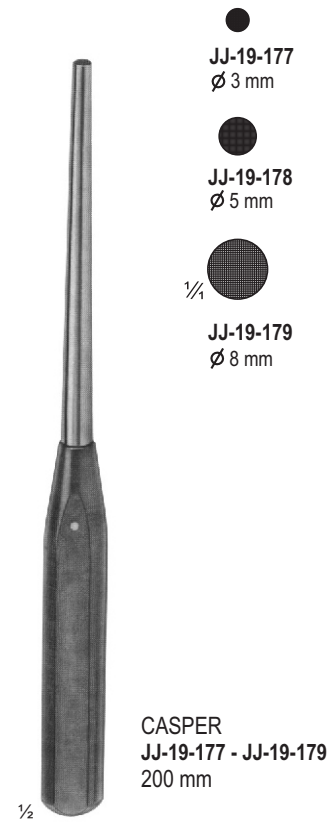
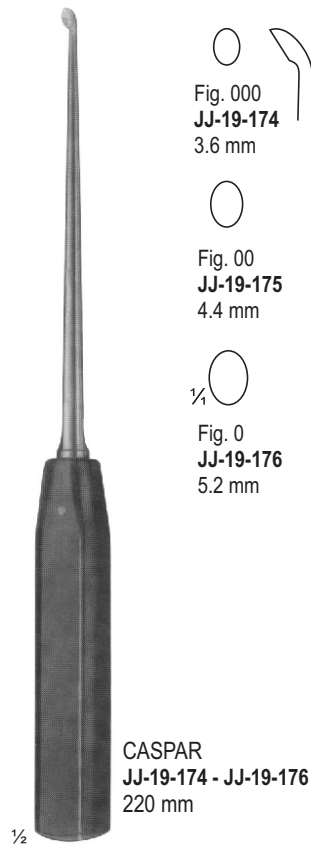
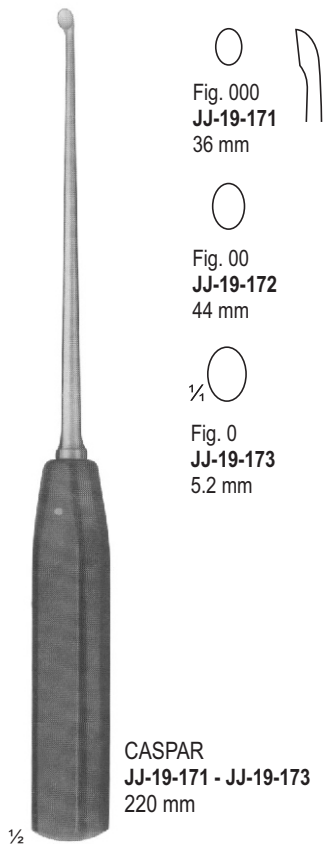

OSTEOTOMES, GOUGES

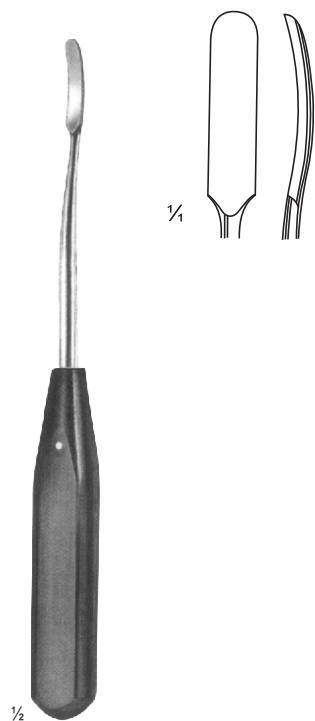

1/2
JJ-19-187
 180 mm
 6 mm

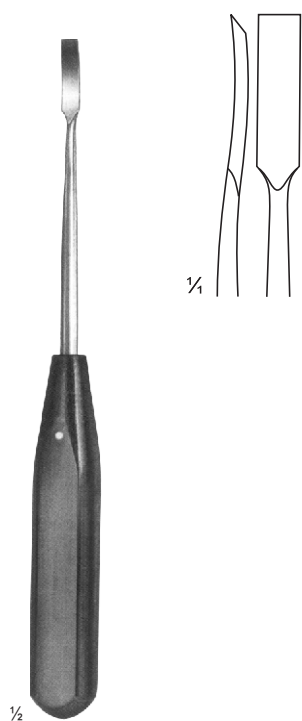

1/2
JJ-19-188
 180 mm
 6 mm

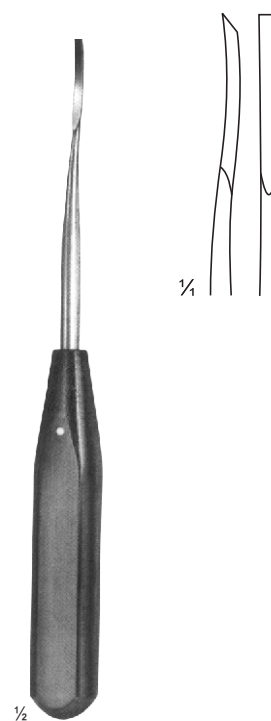

1/2
JJ-19-189
 180 mm
 3 mm

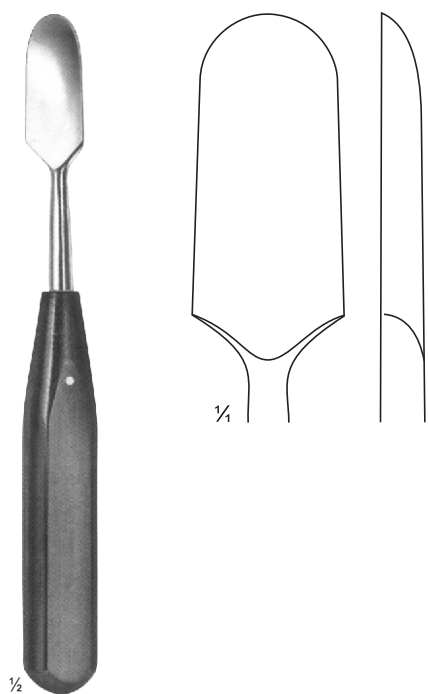

1/2
JJ-19-190
 180 mm
 20 mm

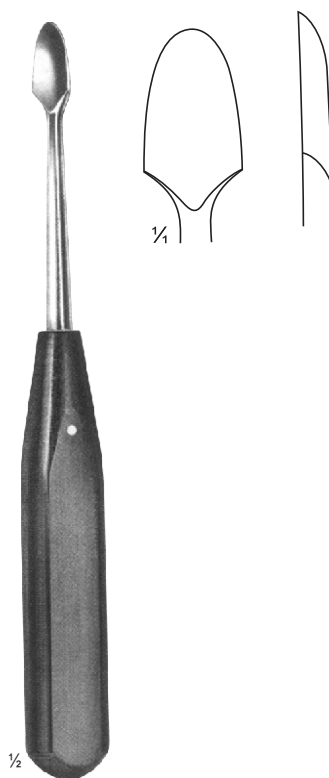

1/2
JJ-19-191
 200 mm
 14 mm

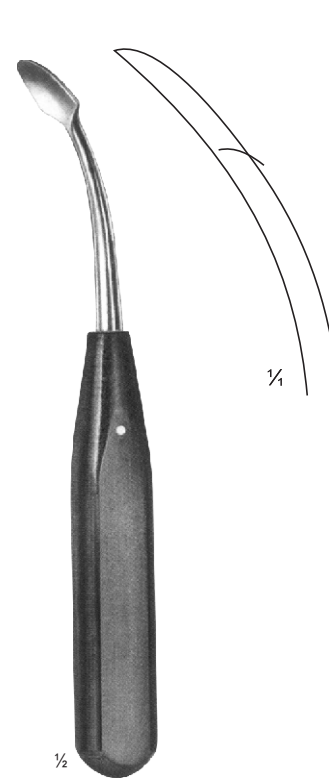

1/2
JJ-19-192
 190 mm
 14 mm

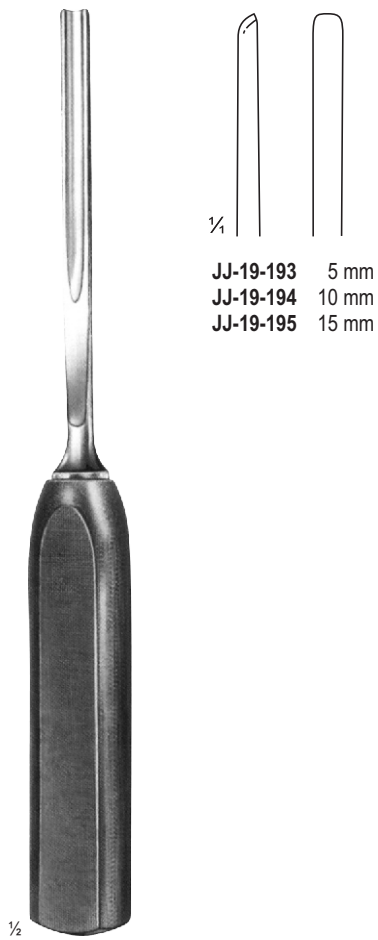

LEXER
JJ-19-193 - JJ-19-195
245 mm

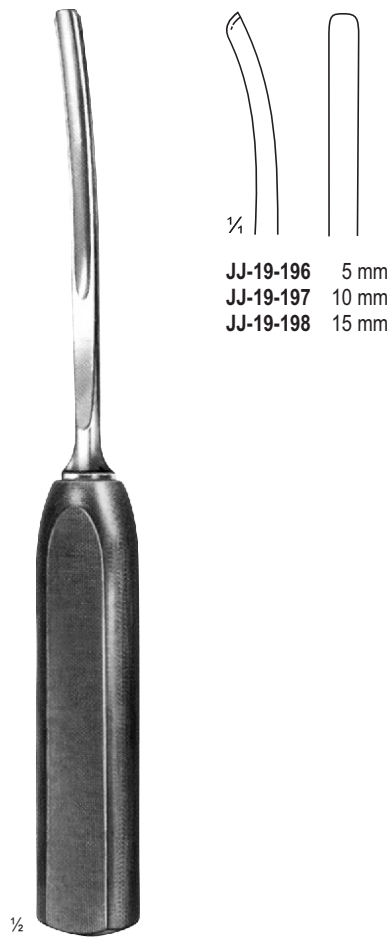

LEXER
JJ-19-196 - JJ-19-198
245 mm

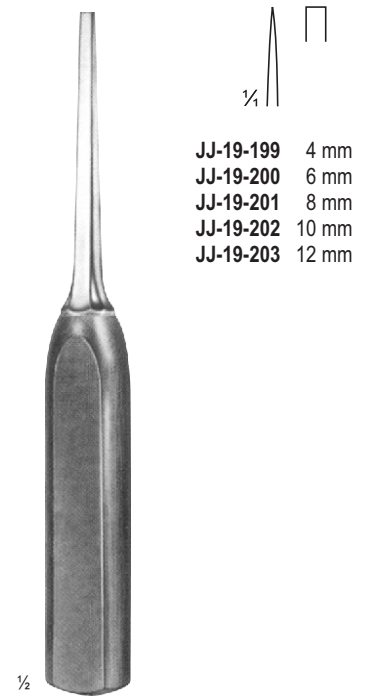

LEXER-MINI
JJ-19-199 - JJ-19-203
180 mm

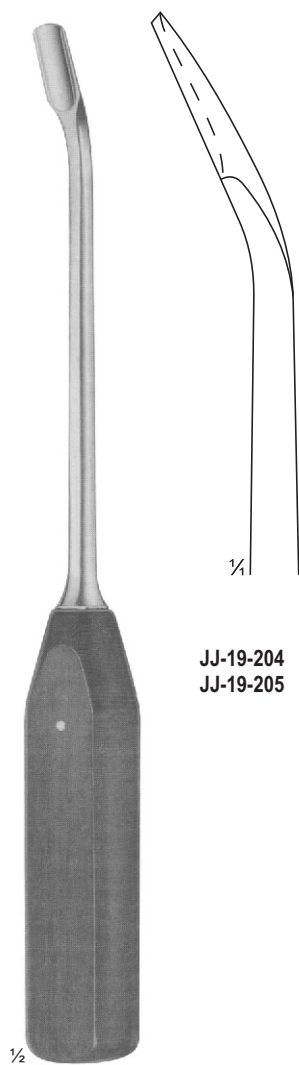

JJ-19-204 10 mm
JJ-19-205 15 mm

LEXER
JJ-19-204 - JJ-19-205
Gouges,
angled
275 mm

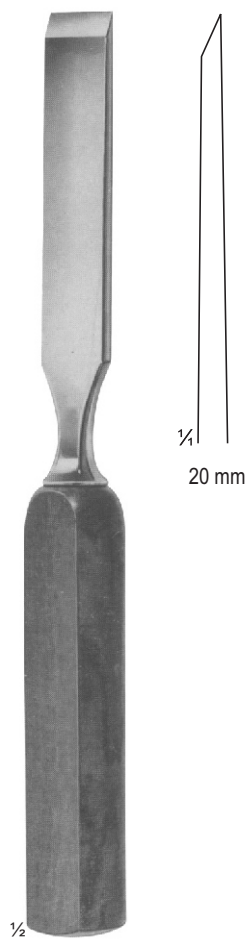

Chisel
JJ-19-206
245 mm

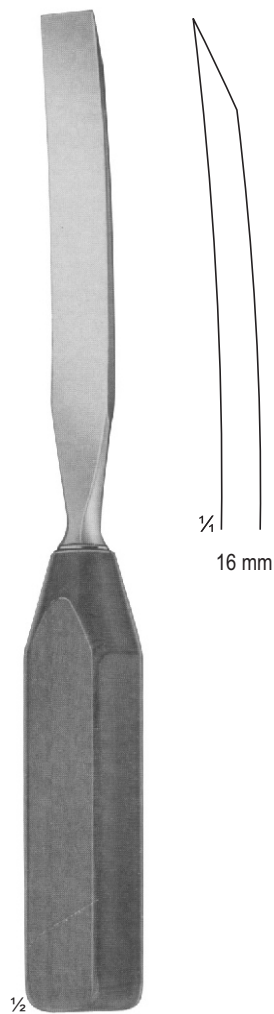

Chisel
curved
JJ-19-207
265 mm

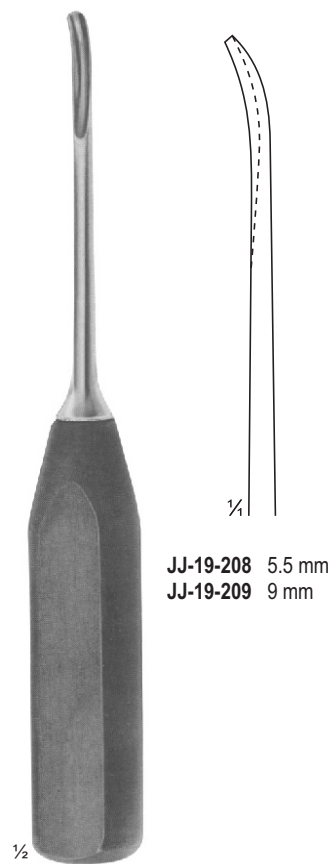

JJ-19-208 5.5 mm
JJ-19-209 9 mm

ZIELKE
JJ-19-208 - JJ-19-209
Gouge for
scoliose-operations
230 mm



1/2

JJ-19-210 - JJ-19-213
270 mm

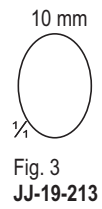
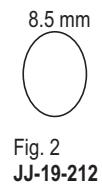
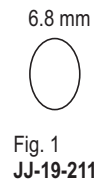
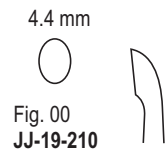

1/2

SYPERT
JJ-19-214 - JJ-19-221
380 mm

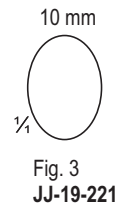
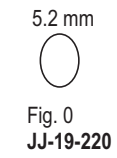
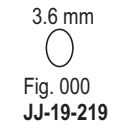
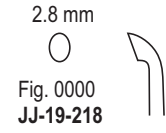
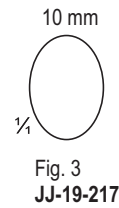
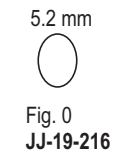
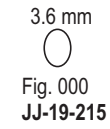
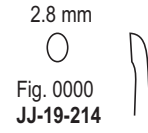

OSTEOTOMES, CHISELS AND GOUGES WITH HANDLE



LANGENBECK
JJ-19-222 - JJ-19-223



JJ-19-222
200 mm



JJ-19-223
200 mm



QUERVAIN
JJ-19-224
200 mm

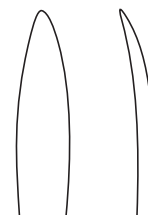

COBB
JJ-19-225 - JJ-19-227



JJ-19-225
28 cm



JJ-19-226
280 mm



JJ-19-227
280 mm



JJ-19-228 - JJ-19-233
JJ-19-228 170 mm
JJ-19-229 170 mm
JJ-19-230 170 mm
JJ-19-231 170 mm
JJ-19-232 190 mm
JJ-19-233 190 mm



½

HOKE
JJ-19-234 - JJ-19-238
170 mm

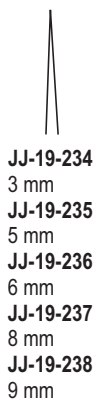

- JJ-19-234
3 mm
- JJ-19-235
5 mm
- JJ-19-236
6 mm
- JJ-19-237
8 mm
- JJ-19-238
9 mm



½

HIBBS
JJ-19-239 - JJ-19-243
245 mm

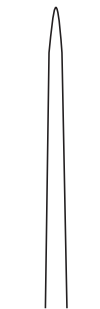

- JJ-19-239
6 mm
- JJ-19-240
13 mm
- JJ-19-241
19 mm
- JJ-19-242
25 mm
- JJ-19-243
32 mm



½

HIBBS
JJ-19-244 - JJ-19-248
245 mm

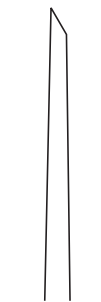

- JJ-19-244
6 mm
- JJ-19-245
13 mm
- JJ-19-246
19 mm
- JJ-19-247
25 mm
- JJ-19-248
32 mm

OSTEOTOMES



1/2

SMITH-PETERSEN
JJ-19-249 - JJ-19-255
205 mm



- JJ-19-249**
6 mm
- JJ-19-250**
9 mm
- JJ-19-251**
13 mm
- JJ-19-252**
16 mm
- JJ-19-253**
19 mm
- JJ-19-254**
25 mm
- JJ-19-255**
32 mm



1/2

SMITH-PETERSEN
JJ-19-256 - JJ-19-262
205 mm



- JJ-19-256**
6 mm
- JJ-19-257**
9 mm
- JJ-19-258**
13 mm
- JJ-19-259**
16 mm
- JJ-19-260**
19 mm
- JJ-19-261**
25 mm
- JJ-19-262**
32 mm



1/2

SMITH-PETERSEN
JJ-19-263 - JJ-19-266
205 mm



- JJ-19-263**
9 mm
- JJ-19-264**
14 mm
- JJ-19-265**
19 mm
- JJ-19-266**
25 mm



1/2

SMITH-PETERSEN
JJ-19-267 - JJ-19-270
205 mm



- JJ-19-267**
9 mm
- JJ-19-268**
14 mm
- JJ-19-269**
19 mm
- JJ-19-270**
25 mm

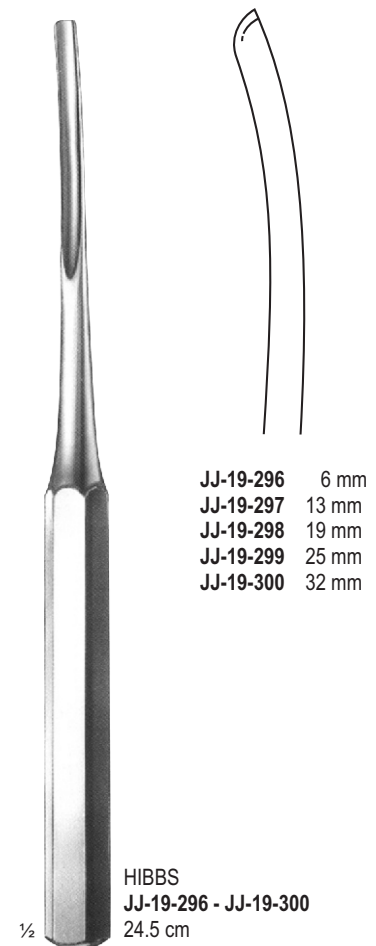
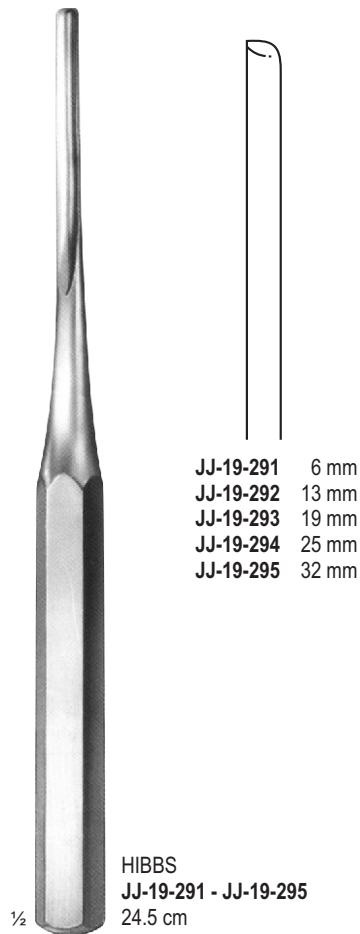
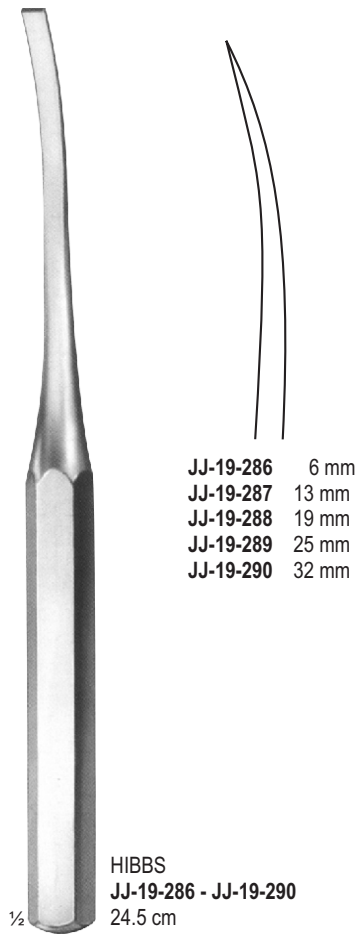
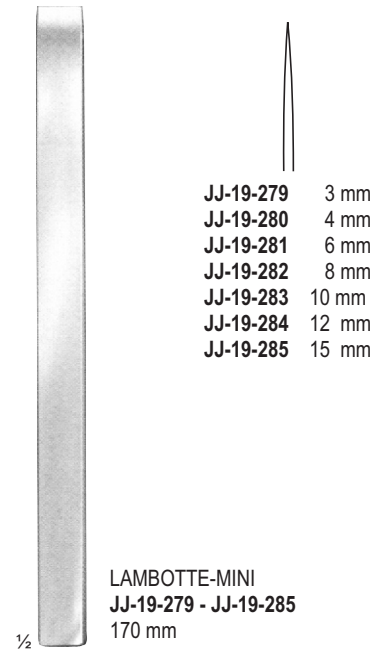
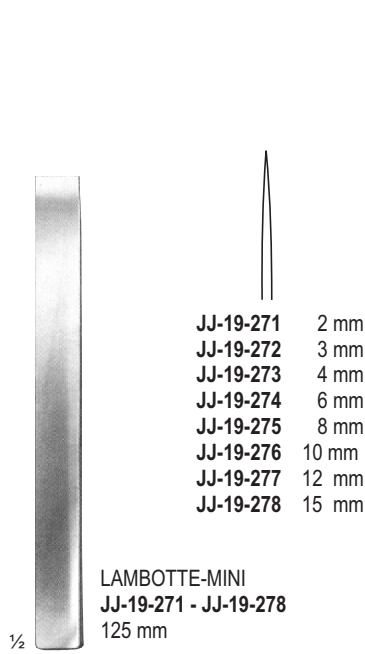

TAMPERS - OSTEOTOMES, CHISELS AND GOUGES

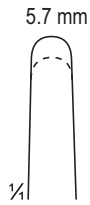

Haase
JJ-19-301
100 mm



1/4 □
JJ-19-302
5.7 mm
1/4 □
JJ-19-303
3.5 mm

PASSOW
JJ-19-302 - JJ-19-303
120 mm



FREER
Chisel
JJ-19-304
160 mm

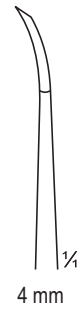

FREER
Chisel, curved
JJ-19-305
160 mm

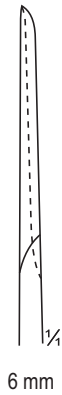

FREER
Gouge
JJ-19-306
150 mm

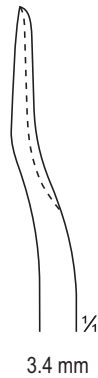

Scaphoid gouge,
downwards curved
JJ-19-307
135 mm



Scaphoid gouge,
upwards curved
JJ-19-308
135 mm



Mannerfelt
JJ-19-309 - JJ-19-311
JJ-19-309 4 mm
JJ-19-310 6 mm
JJ-19-311 8 mm
155 mm

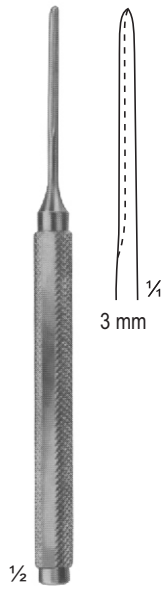

JJ-19-312
Mannerfelt
155 mm

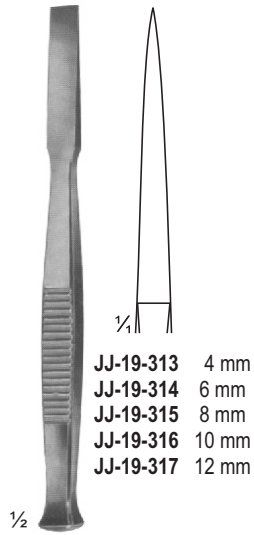

JJ-19-313 - JJ-19-317
Osteotome
140 mm

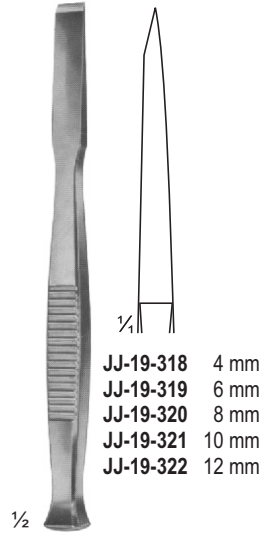

JJ-19-318 - JJ-19-322
Chisels
140 mm

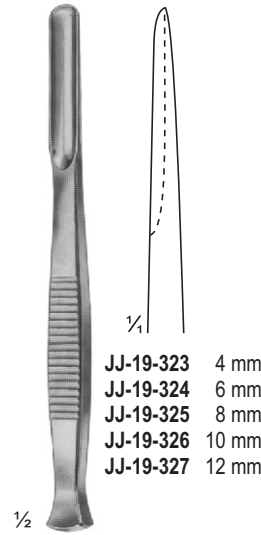

JJ-19-323 - JJ-19-327
Gouges
140 mm

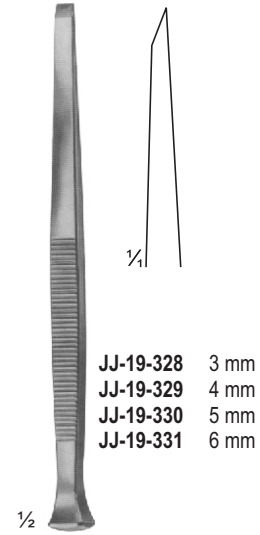

PARTSCH
JJ-19-328 - JJ-19-331
CHISELS
140 mm

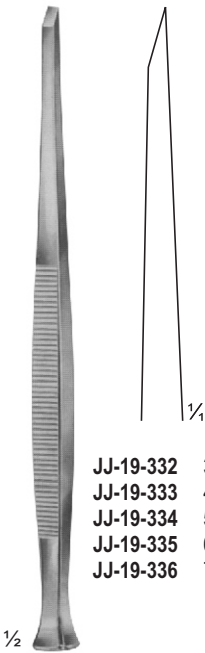

PARTSCH
JJ-19-332 - JJ-19-336
Chisels
170 mm

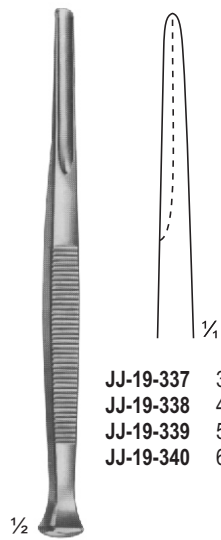

PARTSCH
JJ-19-337 - JJ-19-340
Gouges
140 mm

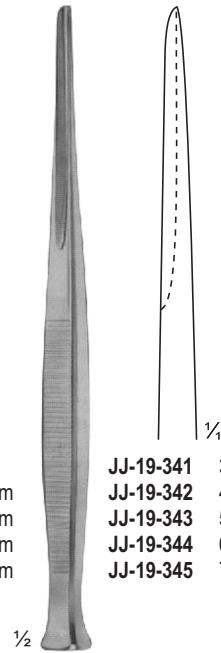

PARTSCH
JJ-19-341 - JJ-19-345
Gouges
170 mm

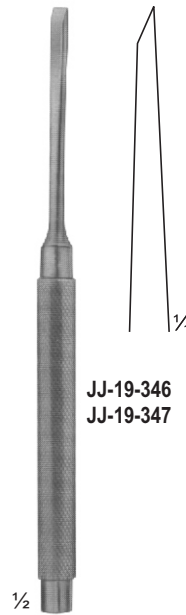

LUCAS
JJ-19-346 - JJ-19-347
Chisels
160 mm

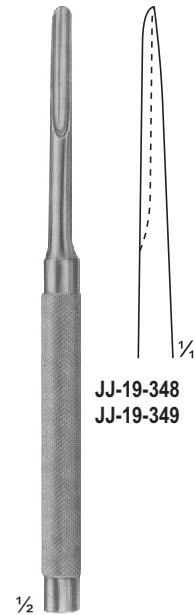

LUCAS
JJ-19-348 - JJ-19-349
Gouges
160 mm

OSTEOTOMES CHISELS AND GOUGES

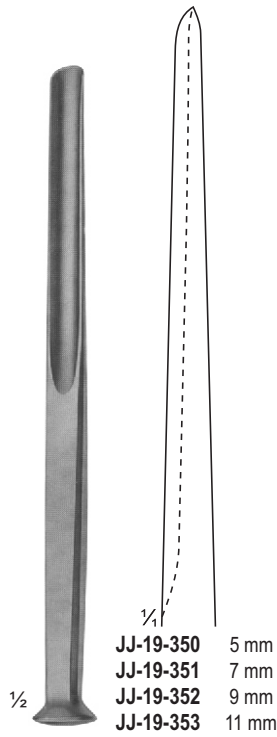

ALEXANDER
JJ-19-350 - JJ-19-353
 Gouges
 170 mm

- JJ-19-350** 5 mm
- JJ-19-351** 7 mm
- JJ-19-352** 9 mm
- JJ-19-353** 11 mm

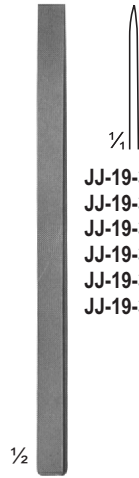

LAMBOTTE
JJ-19-354 - JJ-19-359
 Osteotome
 125 mm

- JJ-19-354** 4 mm
- JJ-19-355** 6 mm
- JJ-19-356** 8 mm
- JJ-19-357** 10 mm
- JJ-19-358** 12 mm
- JJ-19-359** 15 mm

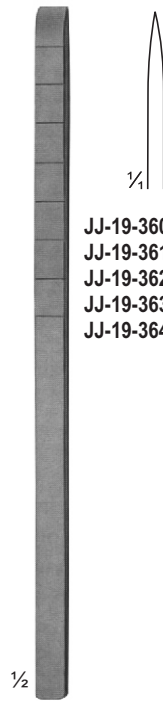

COTTLE
JJ-19-360 - JJ-19-364
 Osteotome with depth markings
 180 mm

- JJ-19-360** 4 mm
- JJ-19-361** 6 mm
- JJ-19-362** 8 mm
- JJ-19-363** 10 mm
- JJ-19-364** 12 mm

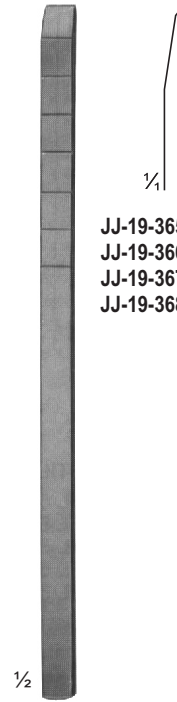

COTTLE
JJ-19-365 - JJ-19-368
 Chisel-Osteotomes with depth markings
 180 mm

- JJ-19-365** 4 mm
- JJ-19-366** 7 mm
- JJ-19-367** 9 mm
- JJ-19-368** 12 mm

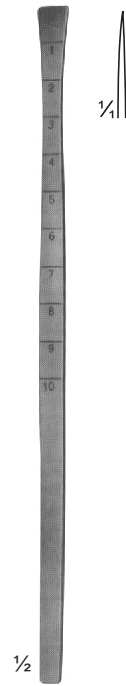

COTTLE
JJ-19-369
 Fishtail Chisel, with protected ends
 180 mm

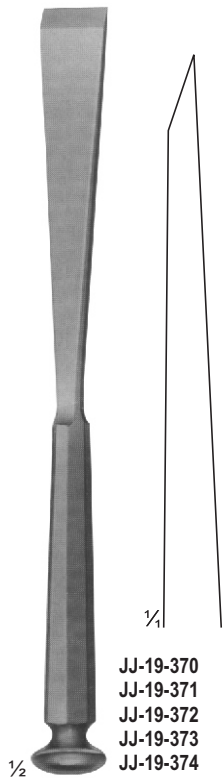

STILLE
JJ-19-370 - JJ-19-374
 Chisels
 205 mm

- JJ-19-370** 10 mm
- JJ-19-371** 12 mm
- JJ-19-372** 15 mm
- JJ-19-373** 20 mm
- JJ-19-374** 25 mm

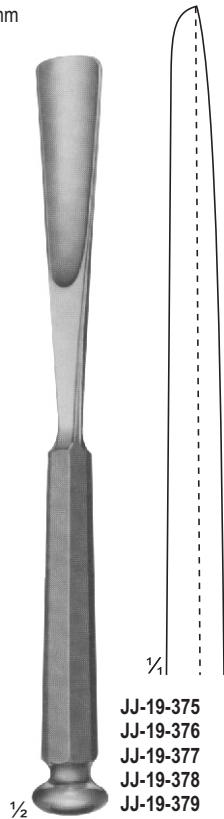

STILLE
JJ-19-375 - JJ-19-379
 Gouges
 205 mm

- JJ-19-375** 10 mm
- JJ-19-376** 12 mm
- JJ-19-377** 15 mm
- JJ-19-378** 20 mm
- JJ-19-379** 25 mm

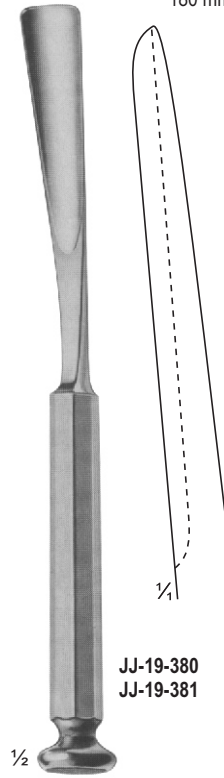

WALTER
JJ-19-380 - JJ-19-381
 Osteotomes gouges for taking grafts from the rib
 205 mm

- JJ-19-380** 10 mm
- JJ-19-381** 15 mm

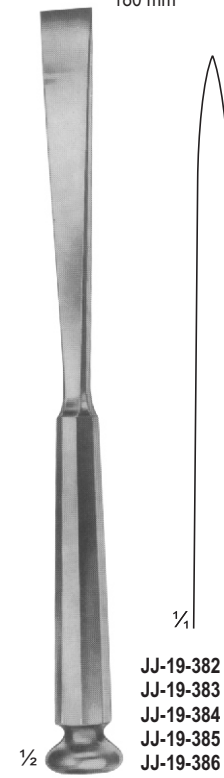

STILLE
JJ-19-382 - JJ-19-386
 Osteotomes
 205 mm

- JJ-19-382** 8 mm
- JJ-19-383** 12 mm
- JJ-19-384** 15 mm
- JJ-19-385** 20 mm
- JJ-19-386** 25 mm

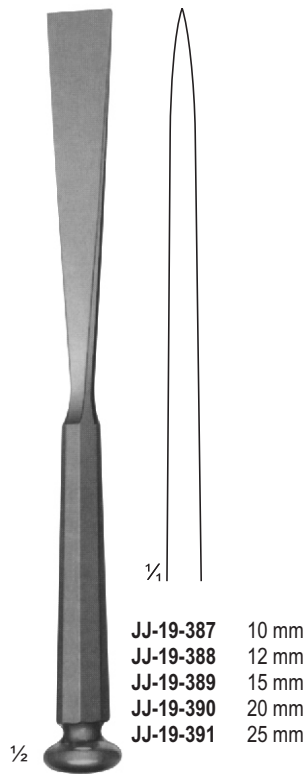

STILLE
JJ-19-387 - JJ-19-391
Osteotomes
205 mm

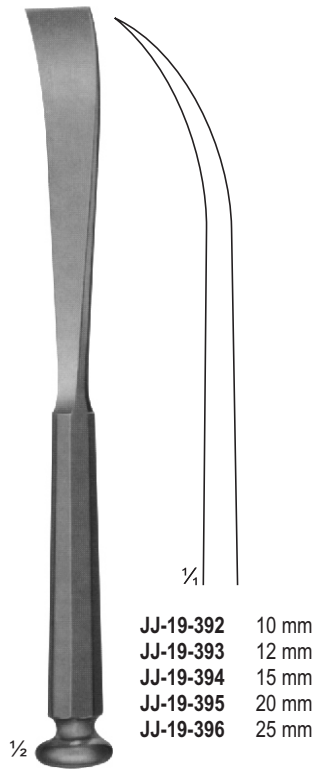

STILLE
JJ-19-392 - JJ-19-396
Osteotomes, curved
205 mm

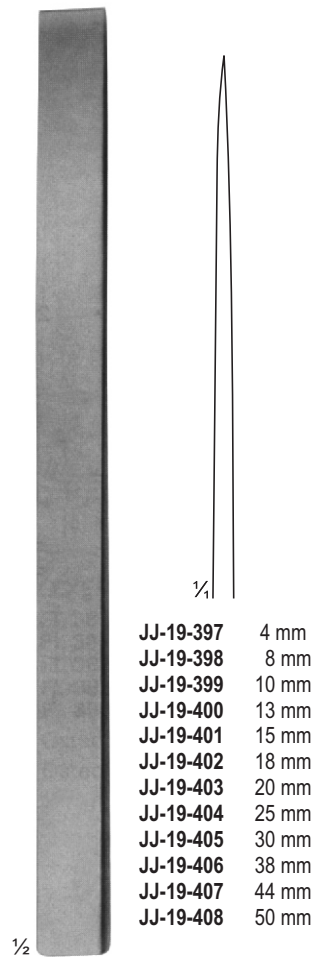



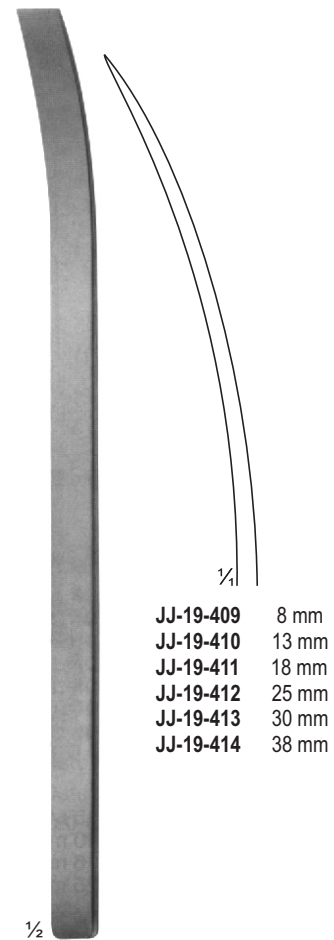







LAMBOTTE
JJ-19-397 - JJ-19-408
Osteotomes
245 mm

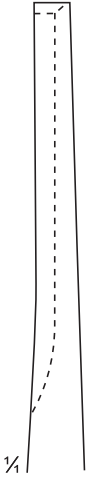

LAMBOTTE
JJ-19-409 - JJ-19-414
Osteotomes, curved
245 mm

OSTEOTOMES, CHISELS AND GOUGES WITH HARTPRESS -HANDLE

 <p>1/2</p>	 <p>1/4</p>	<p>JJ-19-415 4 mm JJ-19-416 6 mm JJ-19-417 8 mm JJ-19-418 10 mm JJ-19-419 12 mm</p>	 <p>1/2</p>	 <p>1/4</p>	<p>JJ-19-420 4 mm JJ-19-421 6 mm JJ-19-422 8 mm JJ-19-423 10 mm JJ-19-424 12 mm</p>	 <p>1/2</p>	 <p>1/4</p>	<p>JJ-19-425 5 mm JJ-19-426 7 mm JJ-19-427 10 mm JJ-19-428 15 mm JJ-19-439 20 mm JJ-19-430 25 mm JJ-19-431 30 mm</p>	
<p>LEXER-MINI JJ-19-415 - JJ-19-419 Osteotomes 180 mm</p>	 <p>1/2</p>	 <p>1/4</p>	<p>LEXER-MINI JJ-19-420 - JJ-19-424 Gouges 180 mm</p>	 <p>1/2</p>	 <p>1/4</p>	<p>LEXER JJ-19-425 - JJ-19-431 Osteotomes 220 mm</p>	 <p>1/2</p>	 <p>1/4</p>	<p>JJ-19-440 5,5 mm JJ-19-441 9,0 mm</p>
<p>LEXER JJ-19-432 - JJ-19-438 Gouges 220 mm</p>	<p>LEXER JJ-19-439 Gouge for removing broken screws 220 mm</p>	<p>ZIELKE JJ-19-440 - JJ-19-441 Gouge for scoliose-operations 230 mm</p>							

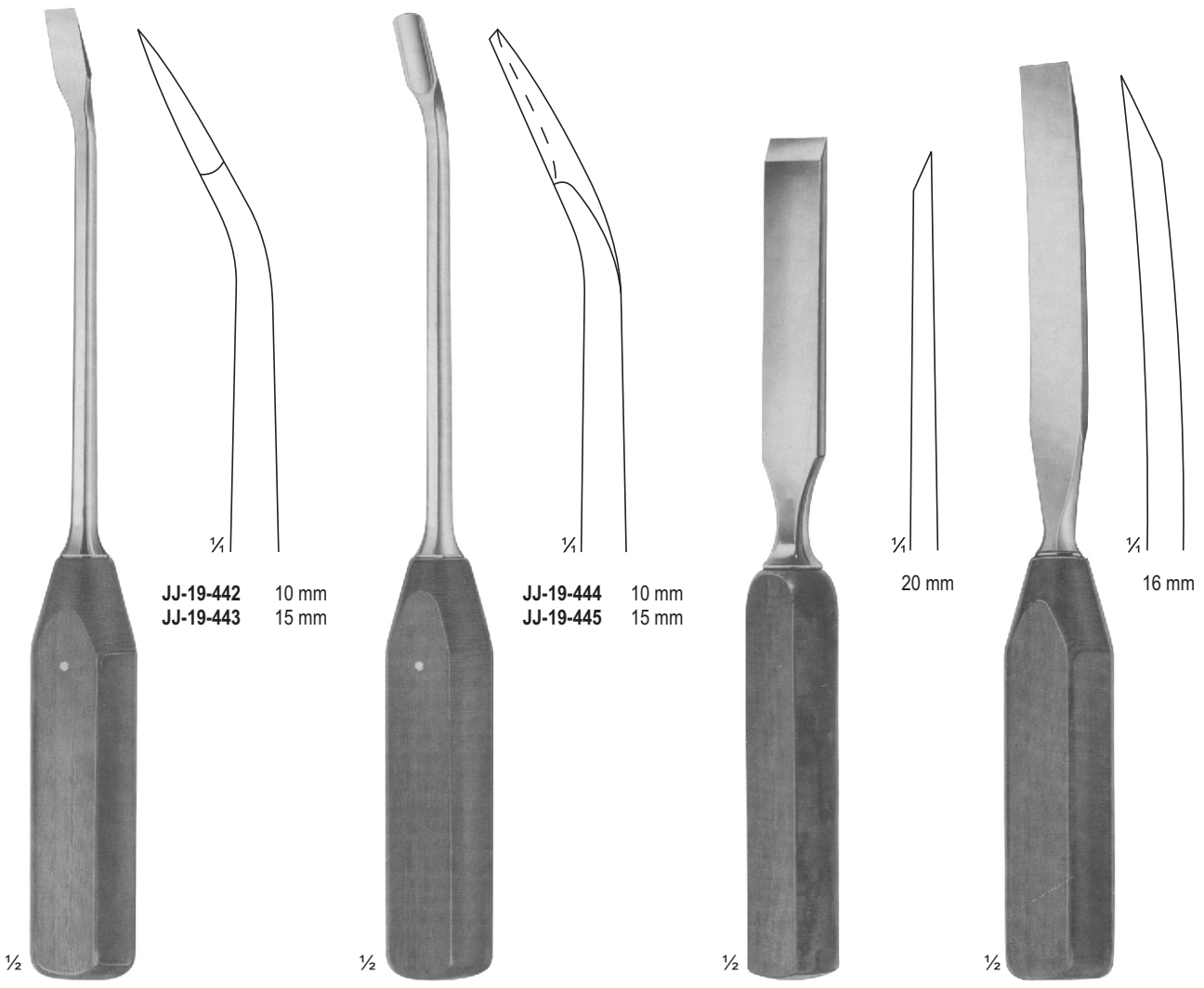

JJ-19-442 10 mm
JJ-19-443 15 mm

JJ-19-444 10 mm
JJ-19-445 15 mm

20 mm

16 mm

LEXER
JJ-19-442 - JJ-19-443
Osteotomes,
angled
275 mm

LEXER
JJ-19-444 - JJ-19-445
Gouges,
angled
275 mm

JJ-19-446
Chisel
245 mm

JJ-19-447
Chisel, curved
265 mm

BONE HOLDING FORCEPS

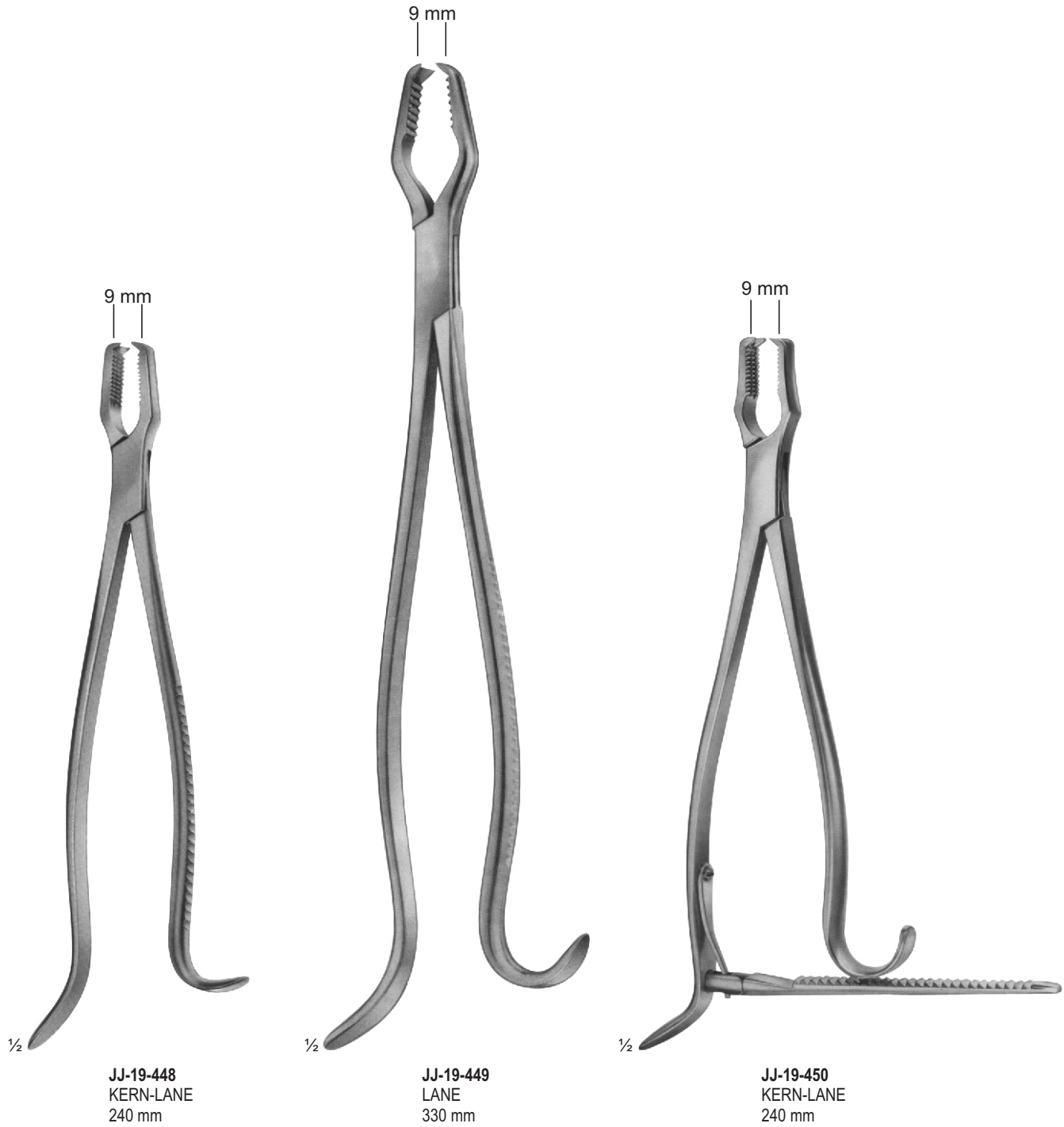



JJ-19-451 - JJ-19-455
JJ-19-451 145 mm
JJ-19-452 190 mm
JJ-19-453 240 mm
JJ-19-454 260 mm
JJ-19-455 280 mm

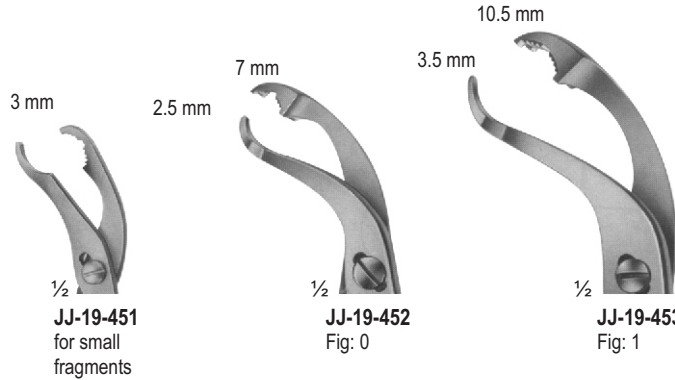

JJ-19-451
for small
fragments

JJ-19-452
Fig: 0

JJ-19-453
Fig: 1

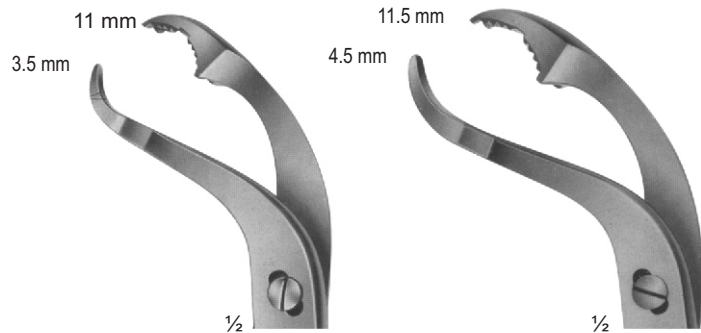

JJ-19-454
Fig: 2

JJ-19-455
Fig: 3

Self-centering forceps
with thread fixation



JJ-19-456 - JJ-19-458
VERBRUGGE
with lip joint

255 mm
265 mm
270 mm

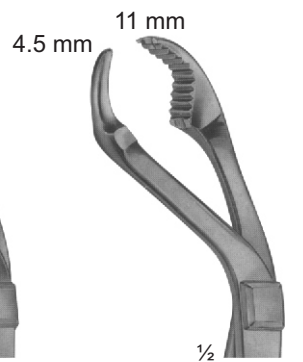

JJ-19-456
Fig: 1

JJ-19-457
Fig: 2



JJ-19-458
Fig: 3



JJ-19-459
LAMBOTTE
265 mm

moveable jaw

adjustable jaw

BONE CLAMPS

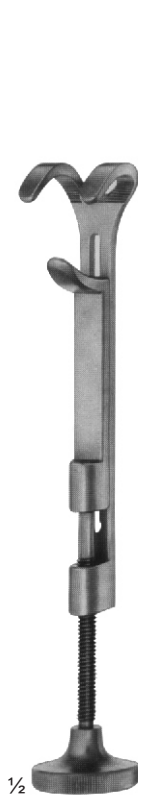

1/2
JJ-19-460 - JJ-19-461
LOWMAN
JJ-19-460 170 mm
JJ-19-461 205 mm



1/2
JJ-19-462
LOWMAN-GERSTER
210 mm



1/2
JJ-19-463
LOWMAN-HOGLUND
175 mm

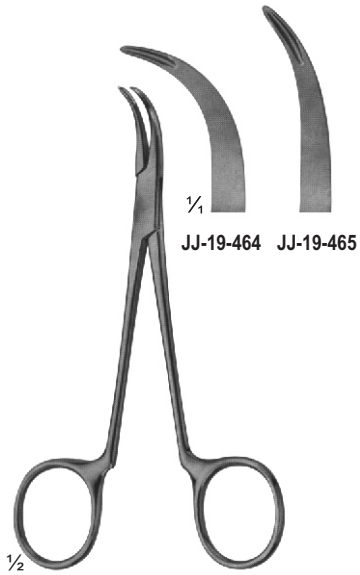

JJ-19-464 - JJ-19-465
Synovectomy rongeur
width of jaws 1.2 mm
130 mm

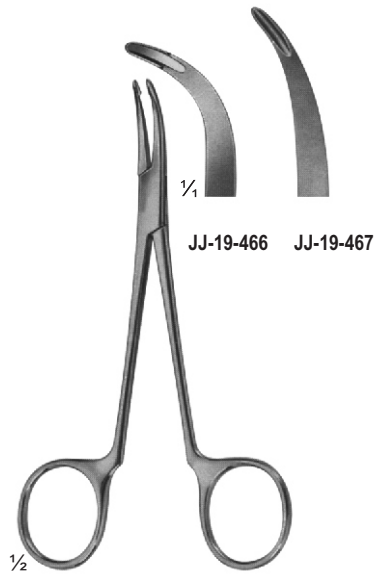

JJ-19-466 - JJ-19-467
Synovectomy rongeur
width of jaws 2.0 mm
130 mm

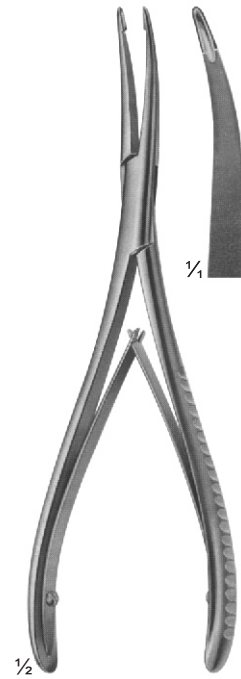

JJ-19-468
STELLBRINK
Synovectomy rongeur
175 mm

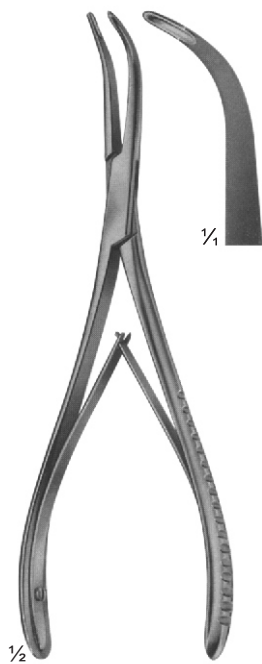

JJ-19-469
STELLBRINK
Synovectomy rongeur
170 mm

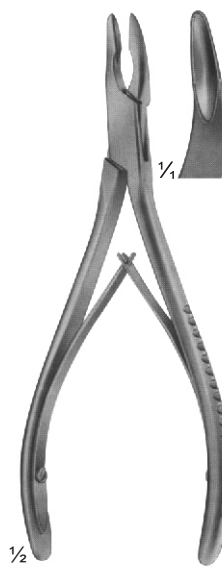

JJ-19-470
LURE-FRIEDMANN
145 mm

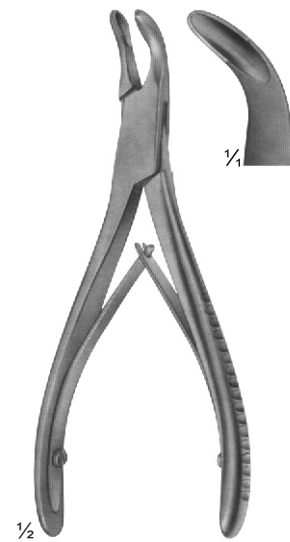

JJ-19-471
140 mm

BONE RONGEURS



JJ-19-472
LURE
150 mm

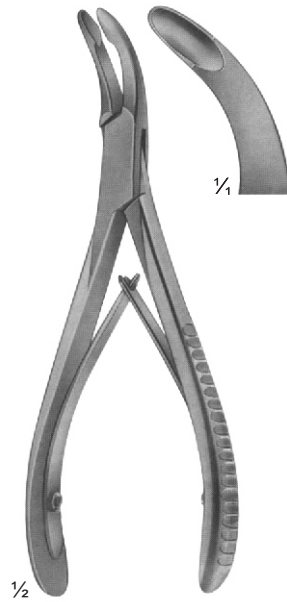

JJ-19-473
LURE
155 mm

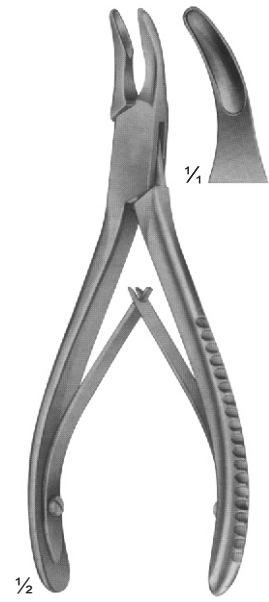

JJ-19-474
BLUMENTHAL
155 mm

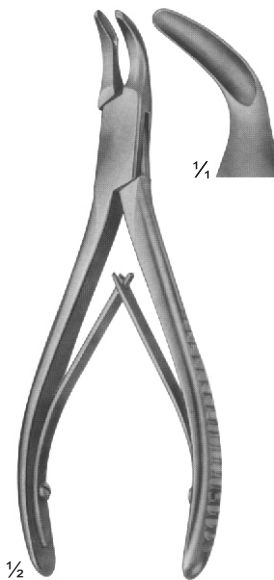

JJ-19-475
BLUMENTHAL
150 mm

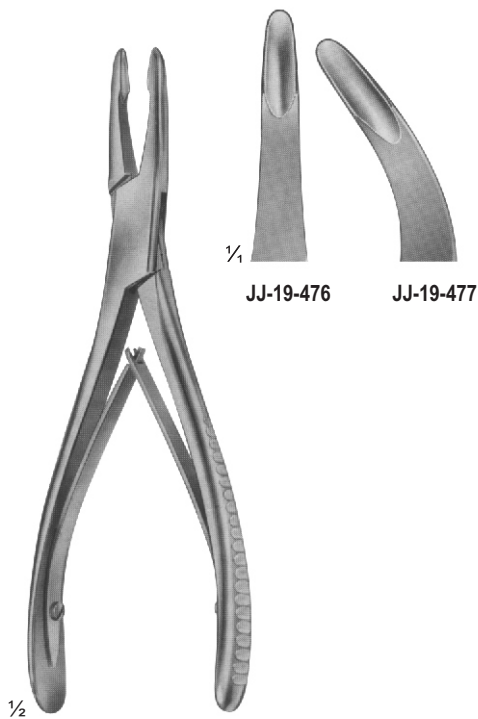

JJ-19-476 - JJ-19-477
JANSEN
175 mm

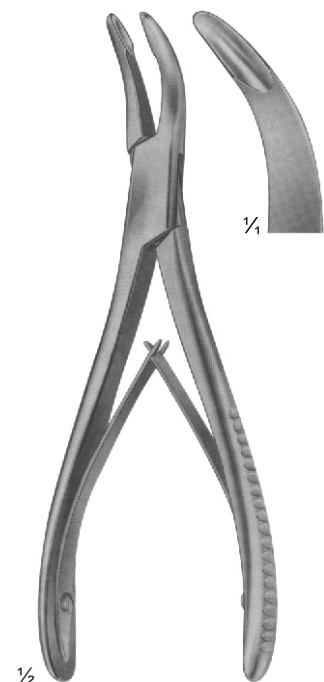

JJ-19-478
BANE-HARTMANN
175 mm

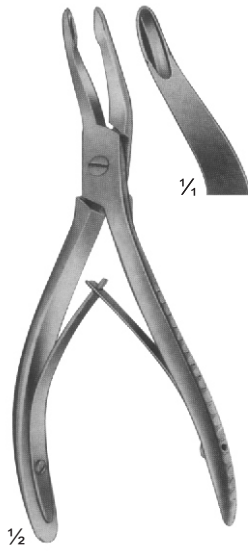

JJ-19-479
ALEXANDER
140 mm

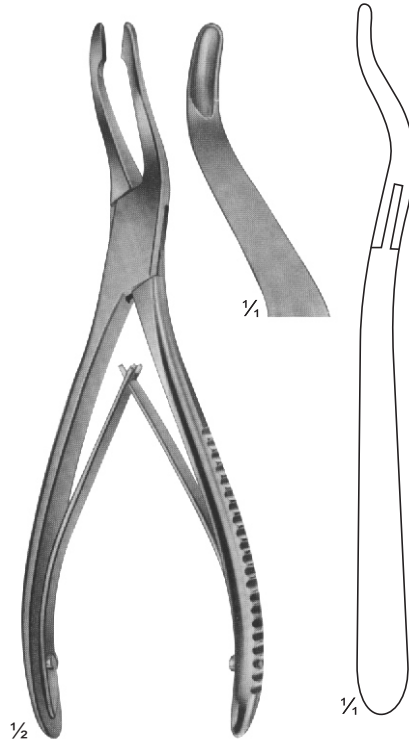

JJ-19-480
JANSEN
190 mm

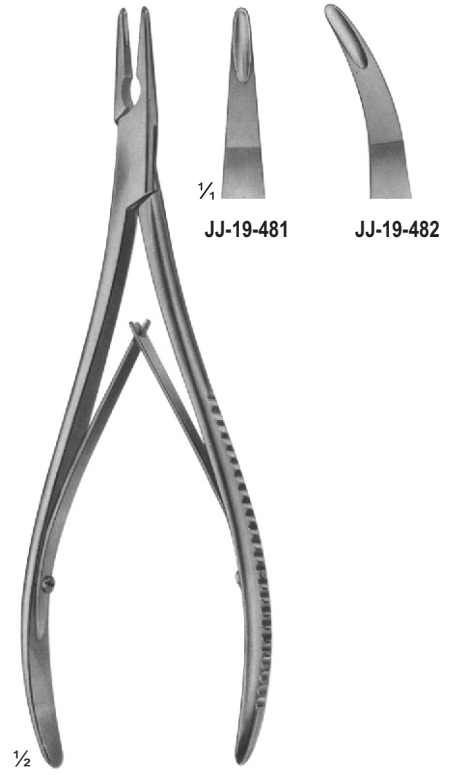

JJ-19-481 - JJ-19-482
LEMPERT
200 mm

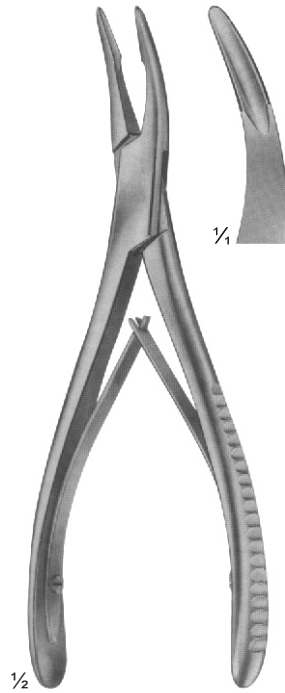

JJ-19-483
BEYER
180 mm

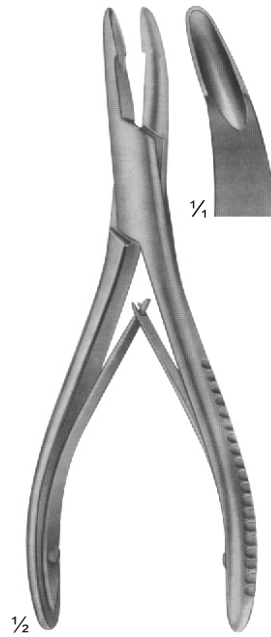

JJ-19-484
MEAD
165 mm

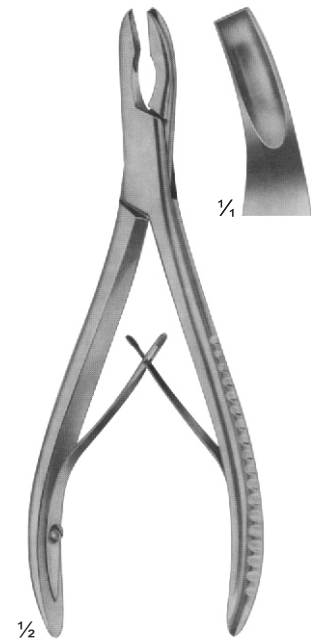

JJ-19-485
MEAD
165 mm

BONE RONGEURS

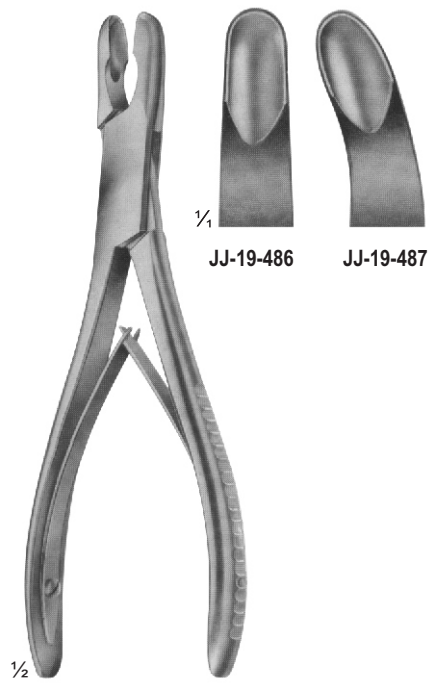

1/4
JJ-19-486 JJ-19-487

JJ-19-486 - JJ-19-487
LURE
175 mm

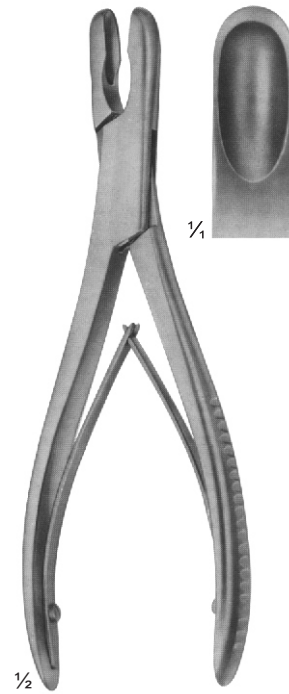

1/4

JJ-19-488
LURE
180 mm

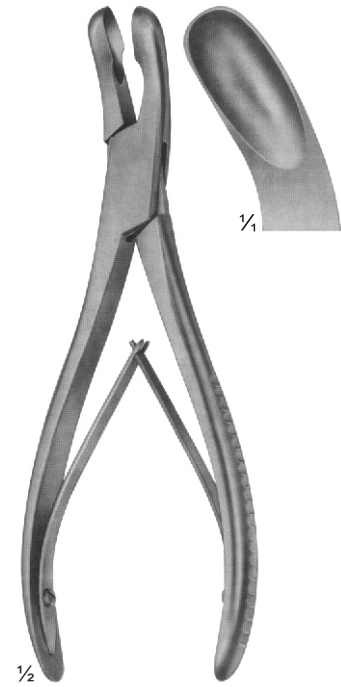

1/4

JJ-19-499
LURE
180 mm

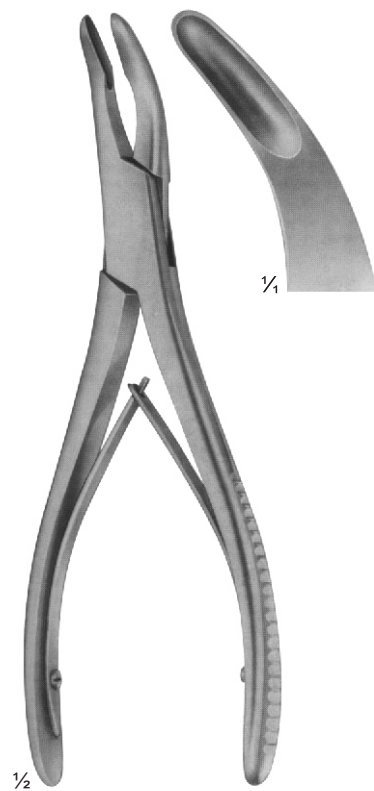

1/4

JJ-19-490
OLIVECRONA
205 mm



1/4
JJ-19-491 JJ-19-492

JJ-19-491 - JJ-19-492
BOHLER
155 mm

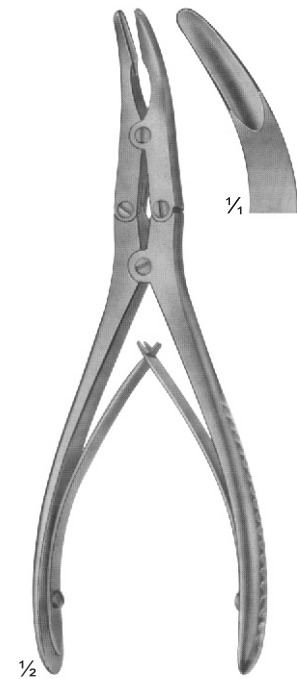

1/4

JJ-19-493
MARQUARTD
200 mm

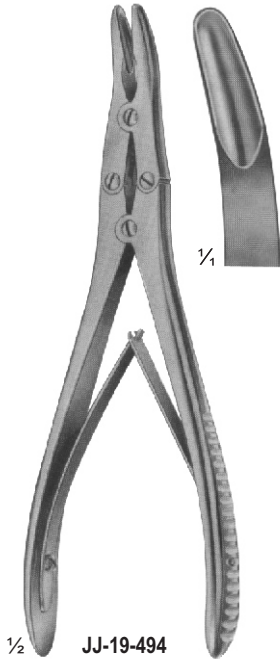

1/2 **JJ-19-494**
RUSKIN
190 mm

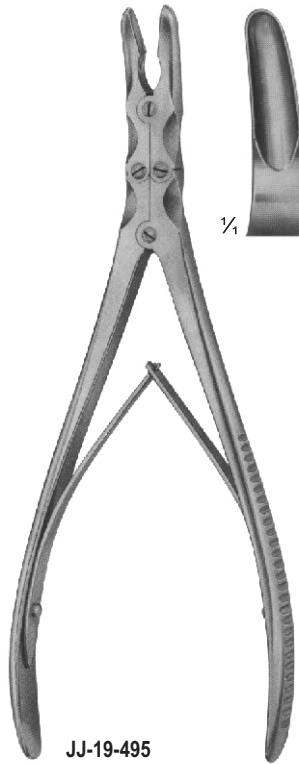

1/2 **JJ-19-495**
ROTTGEN-RUSKIN
240 mm

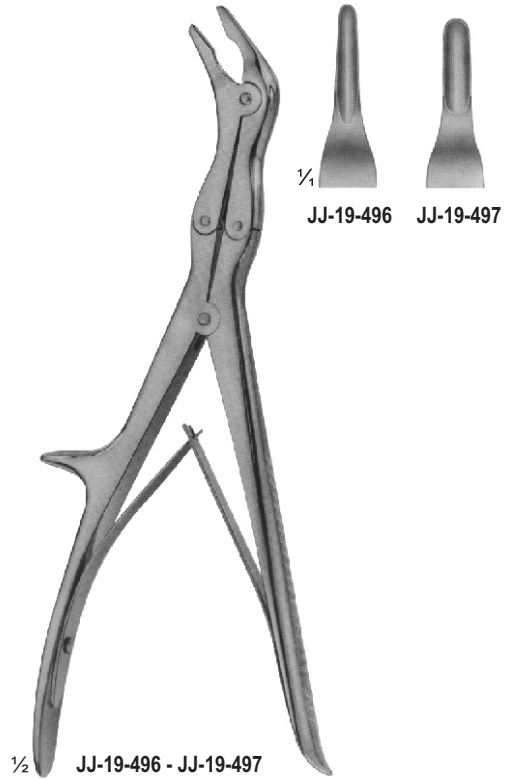

1/2 **JJ-19-496 - JJ-19-497**
ECHLIN
230 mm



1/2 **JJ-19-498**
STILLE
235 mm

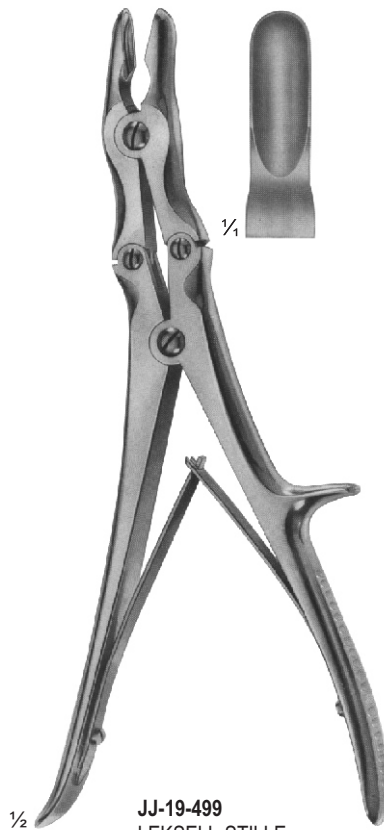

1/2 **JJ-19-499**
LEKSELL-STILLE
240mm

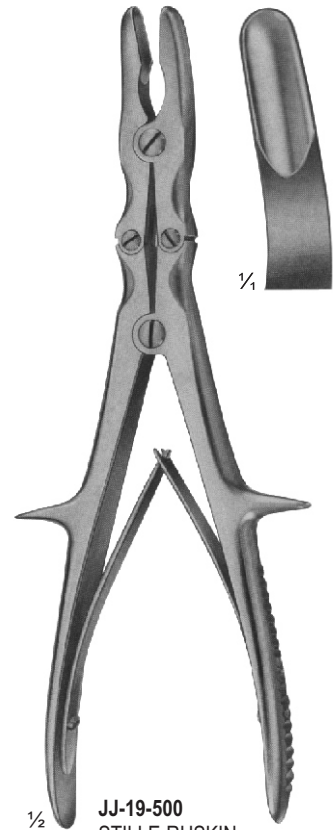

1/2 **JJ-19-500**
STILLE-RUSKIN
240mm

BONE RONGEURS

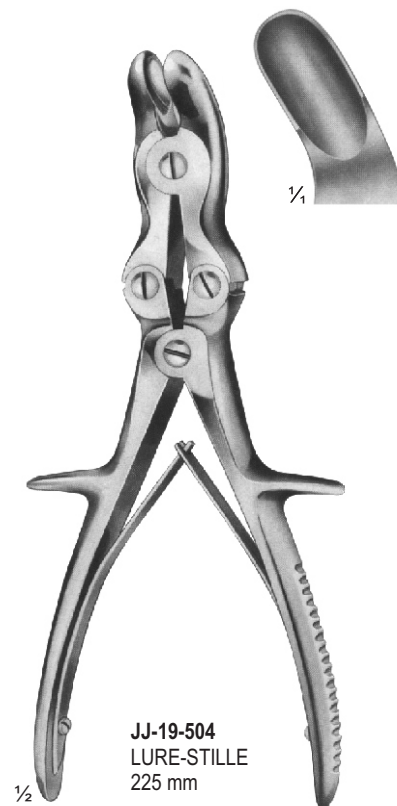
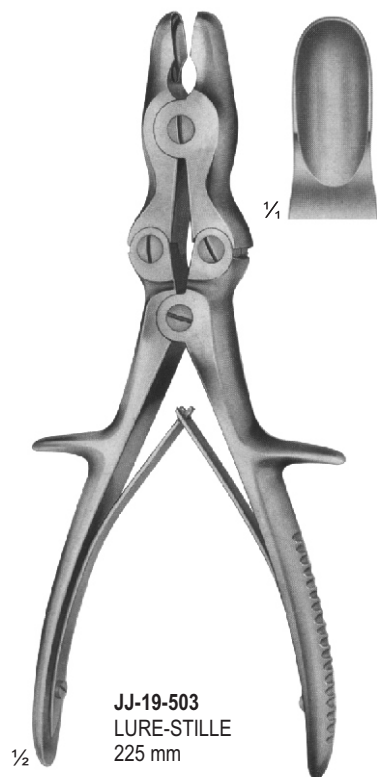
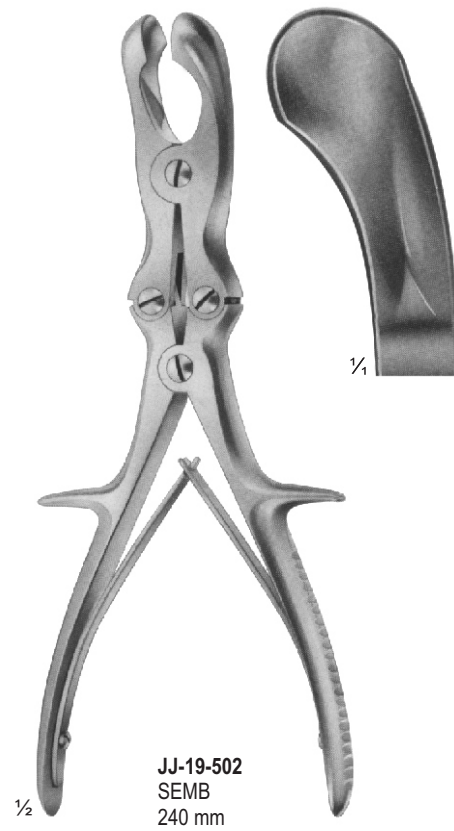
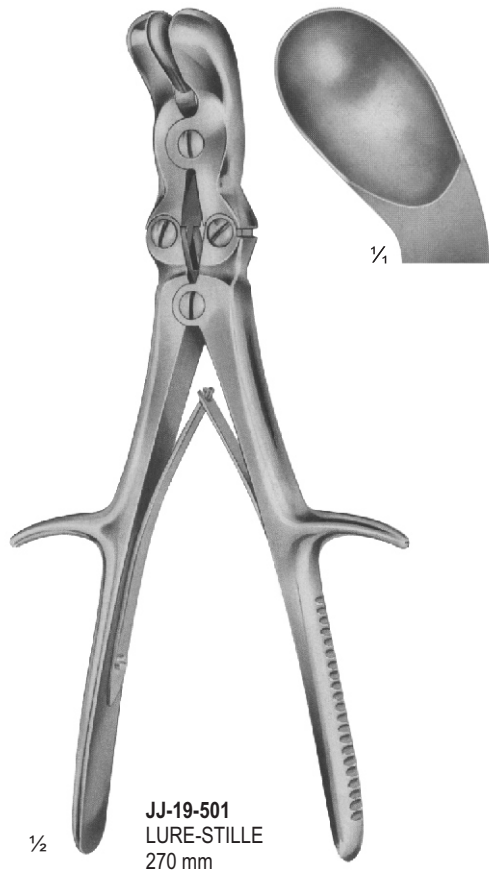

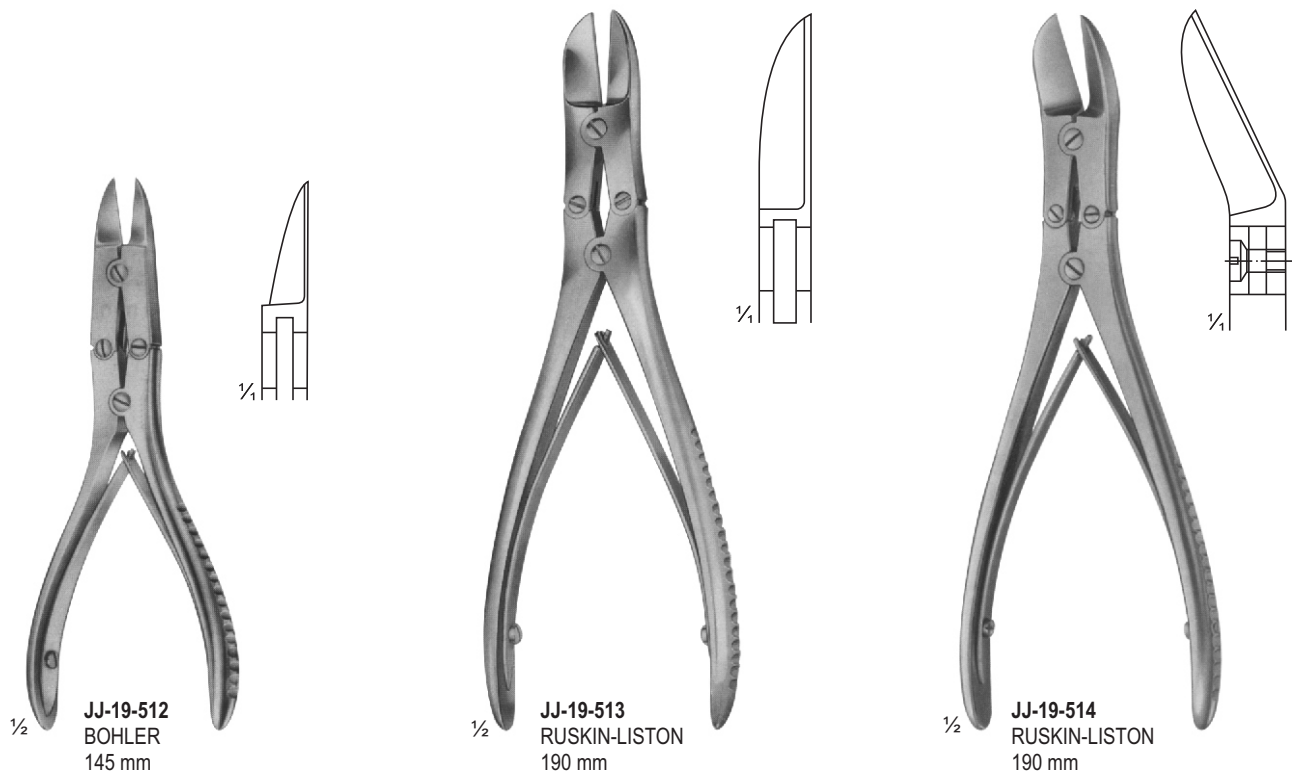
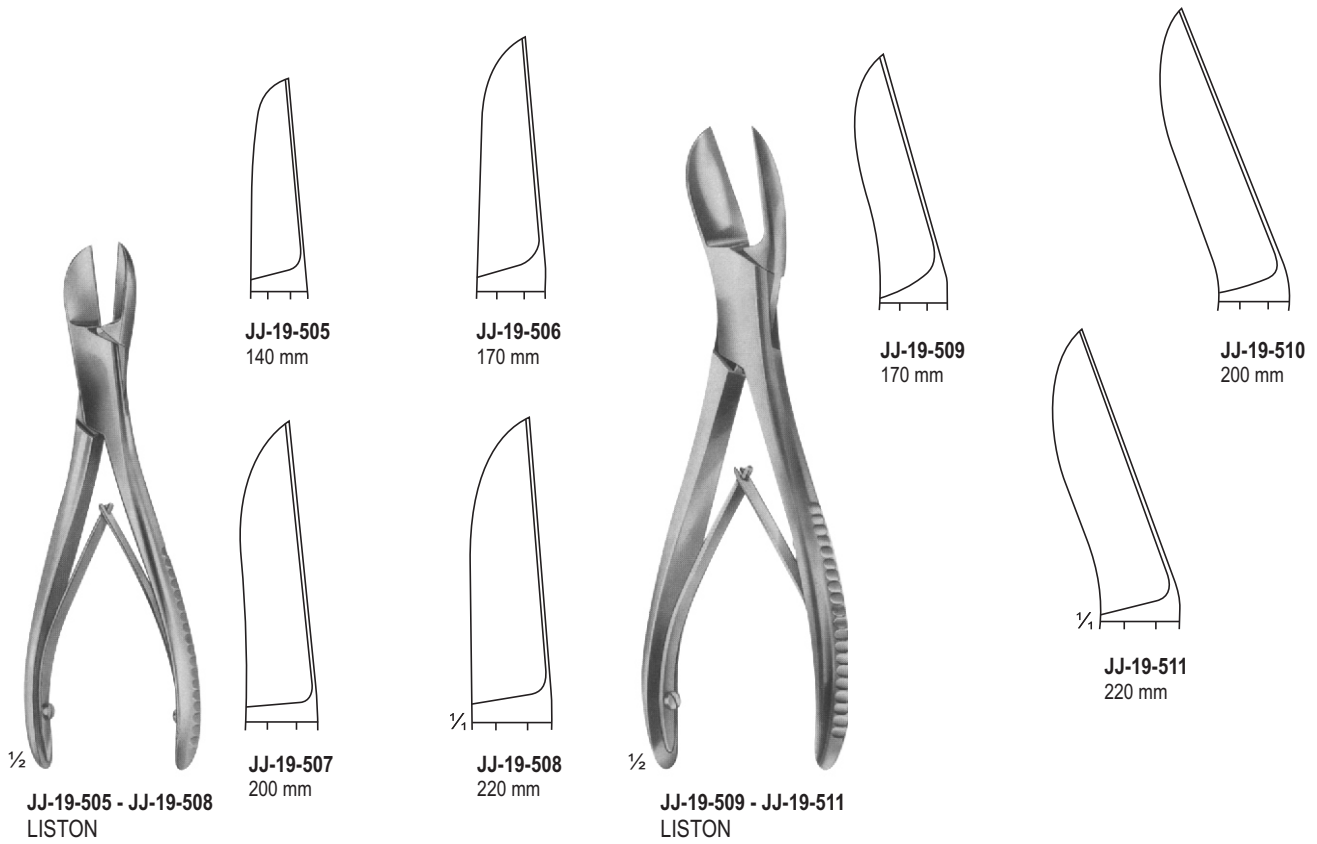

BONE CUTTING FORCEPS

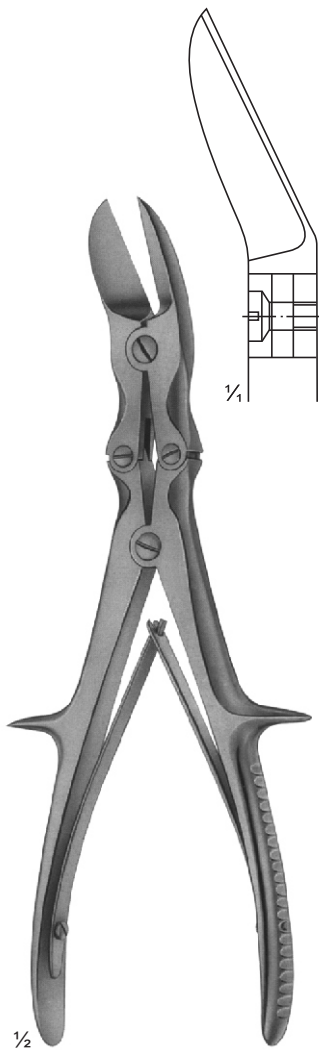

JJ-19-515
LISTON
curved on flat
240 mm

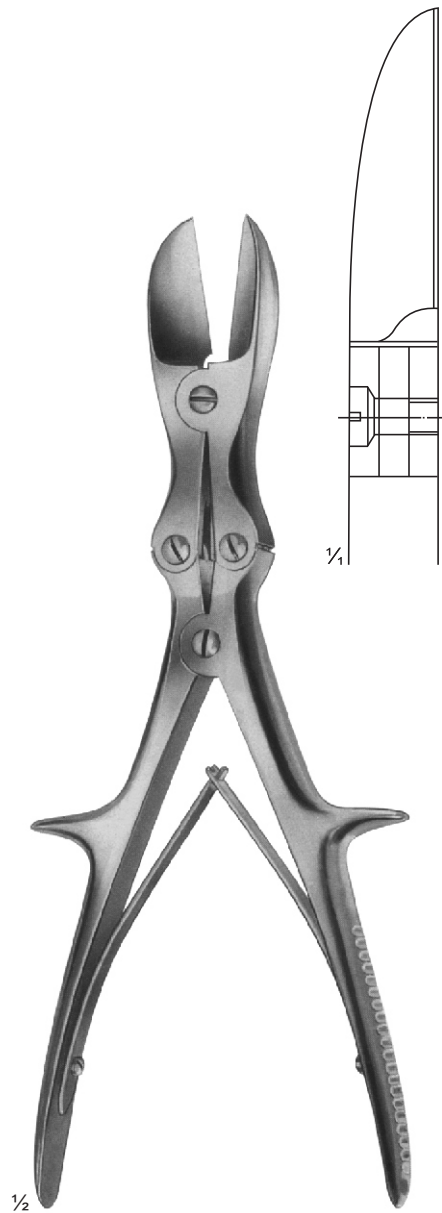

JJ-19-516
LISTON
straight
280 mm

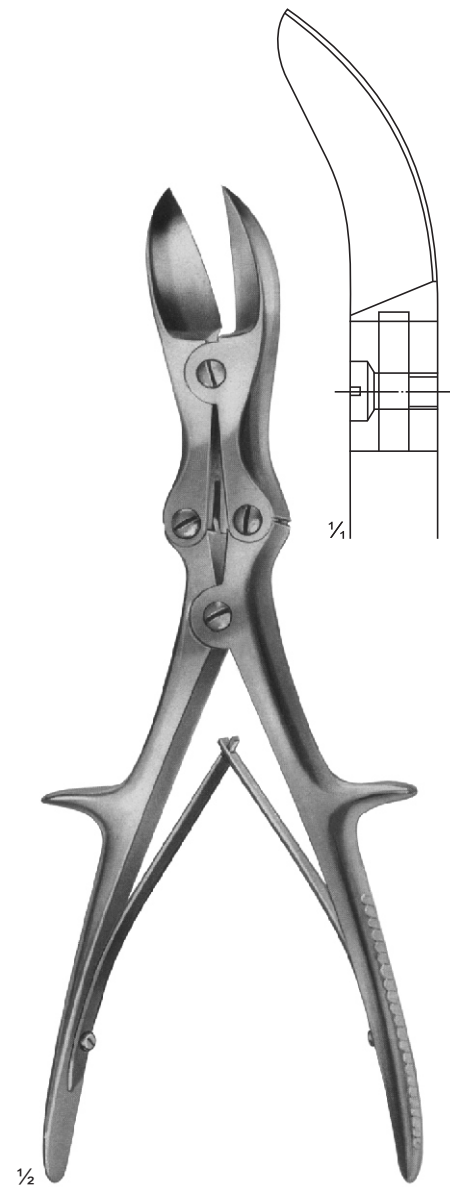

JJ-19-517
LISTON
curved on flat
280 mm

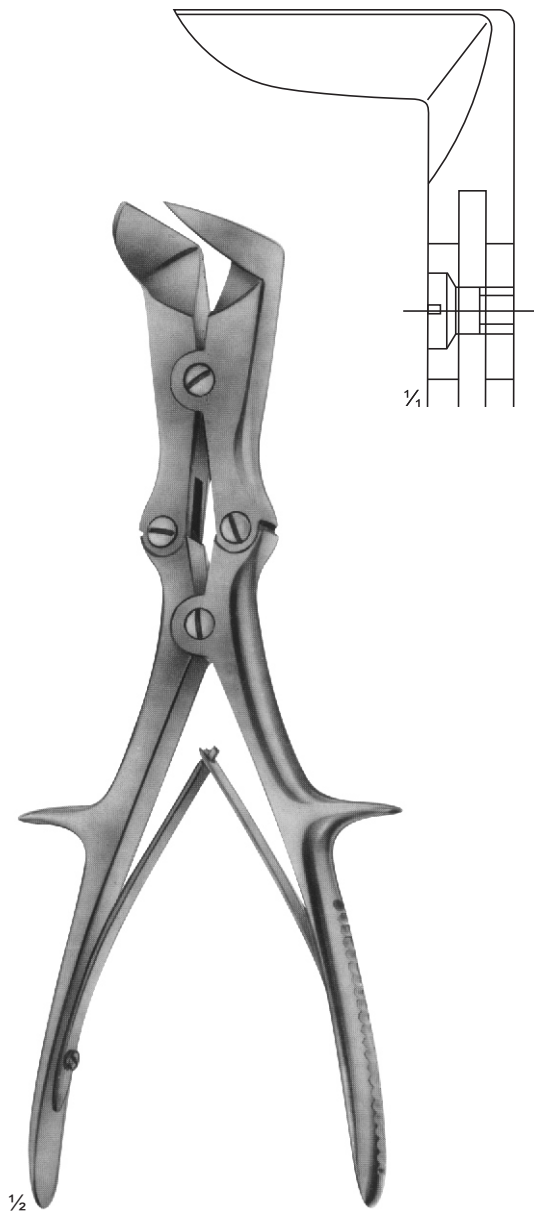

1/2

JJ-19-518
LISTON-STILLE
265 mm

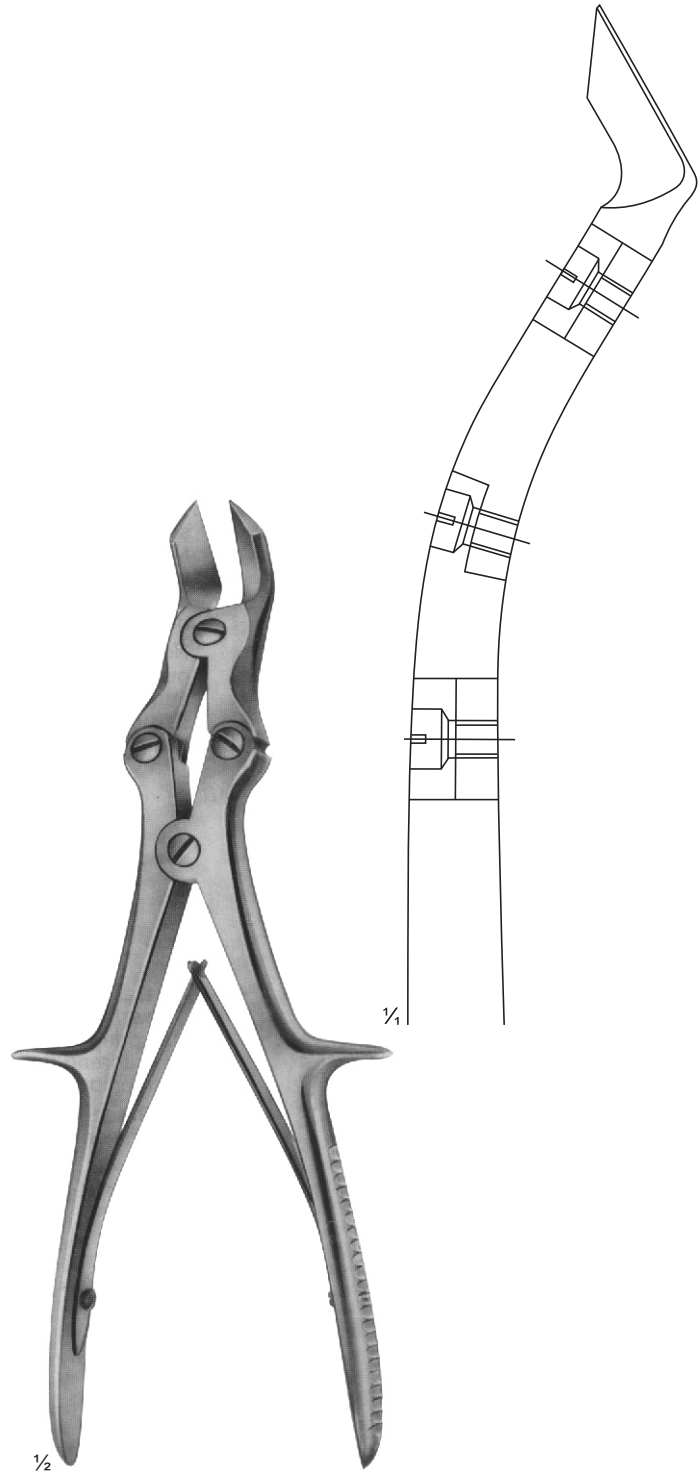

1/2

JJ-19-519
LISTON-KEY-HORSLEY
(TUDOR EDWARDS)
255 mm

MENISCUS KNIVES

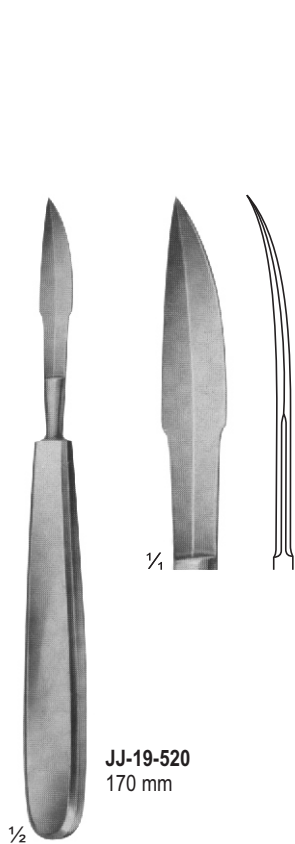

JJ-19-520
170 mm

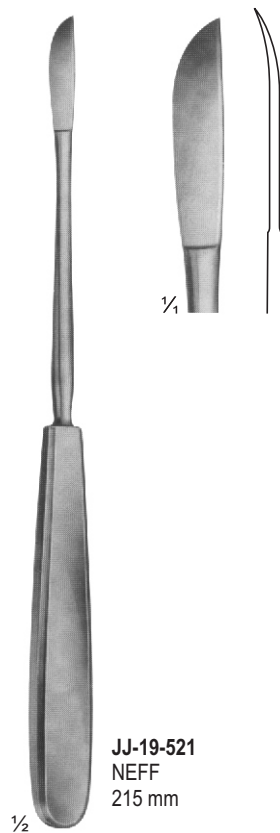

JJ-19-521
NEFF
215 mm

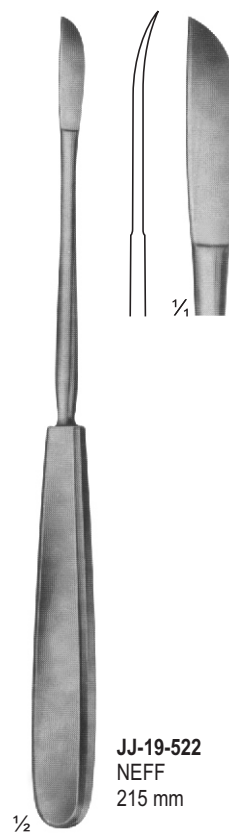

JJ-19-522
NEFF
215 mm

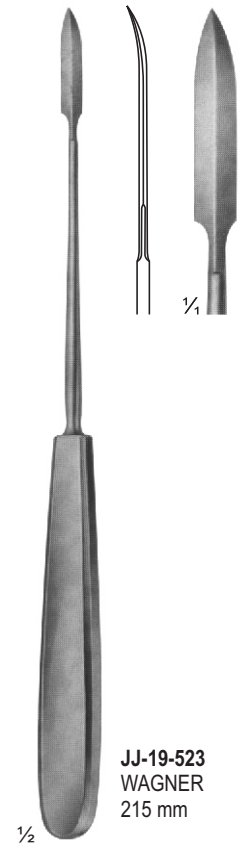

JJ-19-523
WAGNER
215 mm

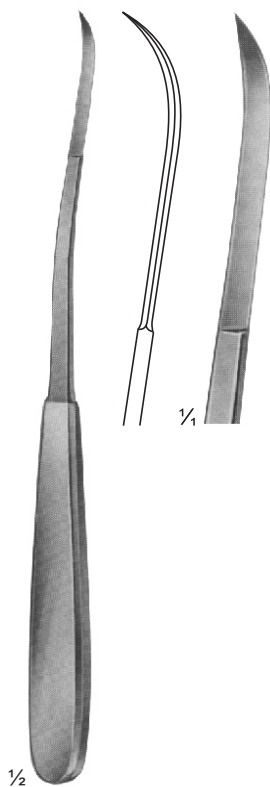

JJ-19-524
SALENIUS
220 mm

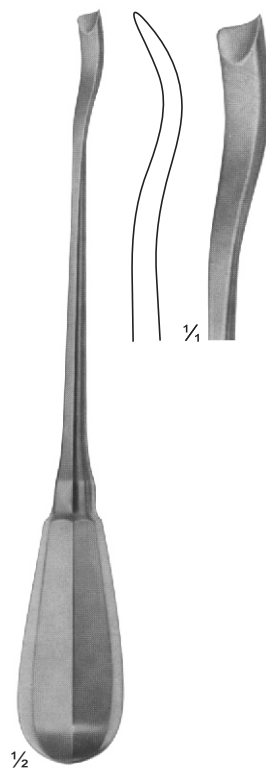

JJ-19-525
CHNAD.MODELL
200 mm

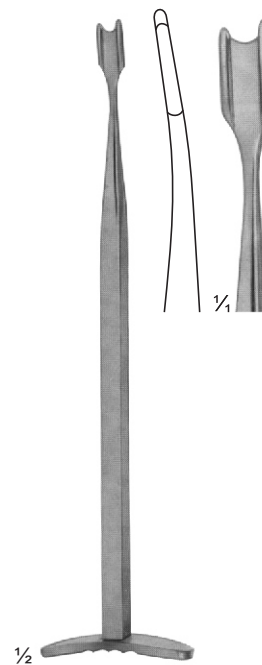

JJ-19-526
SMILLIE
170 mm

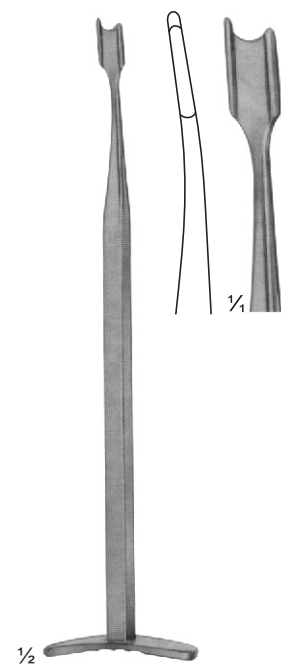

JJ-19-527
SMILLIE
170 mm

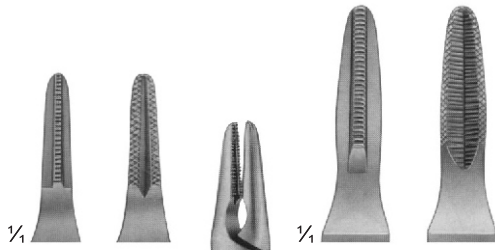

JJ-19-528
130 mm

JJ-19-529
180 mm



Extraction pliers
for boring wires
JJ-19-528 - JJ-19-529

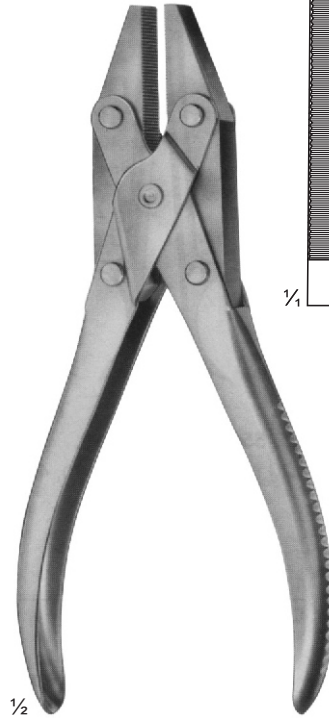

Flat-nosed pliers,
parallel
JJ-19-530
185 mm

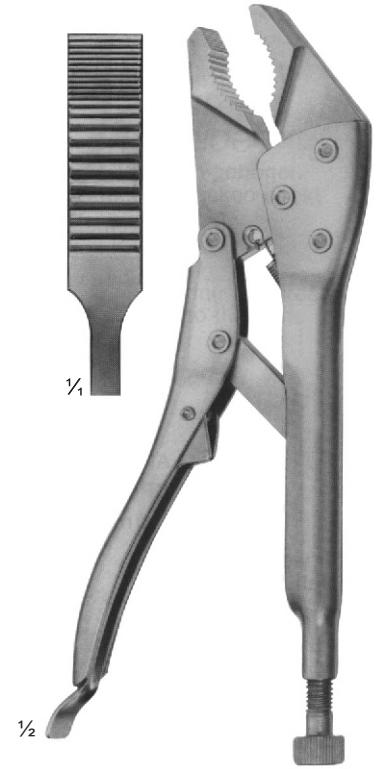
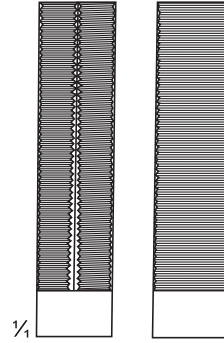

Vise grip
JJ-19-531
200 mm

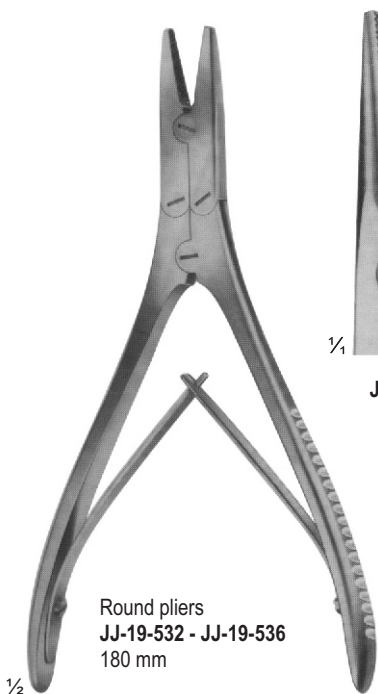

Round pliers
JJ-19-532 - JJ-19-536
180 mm

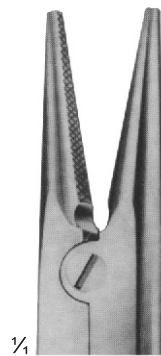

JJ-19-532



JJ-19-533



JJ-19-534



JJ-19-535



JJ-19-536

JJ-19-533
JJ-19-534 14.5 cm
JJ-19-535 18 cm
JJ-19-536 18 cm
Extraction pliers for wires

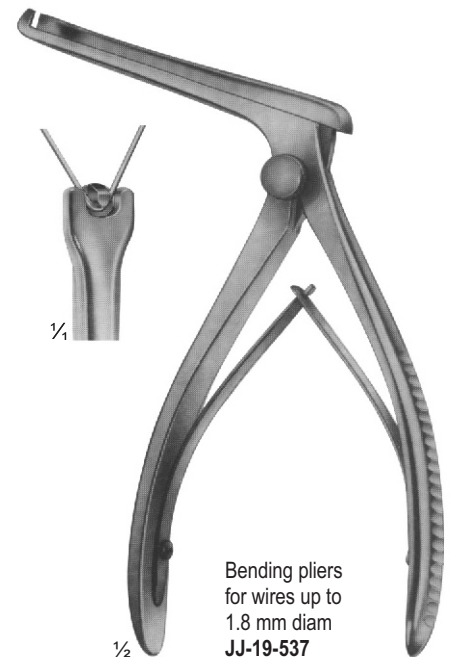

Bending pliers
for wires up to
1.8 mm diam
JJ-19-537

BONE CUTTING FORCEPS



BOHLER
JJ-19-538
145 mm

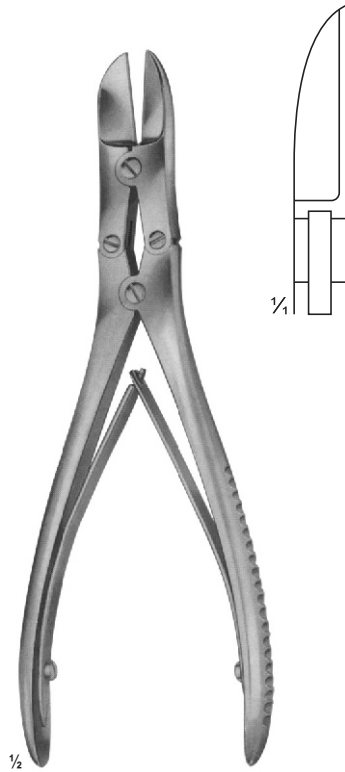

RUSKIN-LISTON
JJ-19-539
190 mm

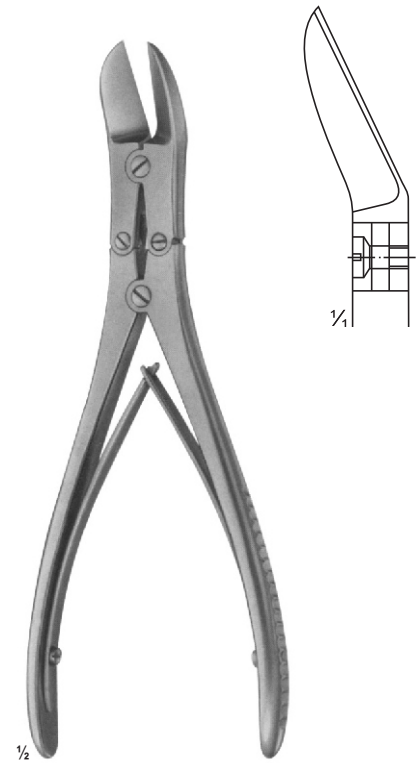

RUSKIN-LISTON
JJ-19-540
190 mm



JJ-19-541
180 mm

for soft wire
up to diam. 2,0 mm
For hard wire 1,5 mm
up to diam
specially hardened
cutting edges, front
and lateral cutting
action

REILL
JJ-19-542
175 mm

for soft wire
up to diam. 2,0 mm
For hard wire 1,6 mm
up to diam
specially hardened
cutting edges, for
cutting off wires close
to the bone

JJ-19-543
235 mm

for soft wire
up to diam. 3,0 mm
For hard wire 2,2 mm
up to diam

WIRE CUTTING PLIERS, LATERAL AND FRONT CUTTING ACTION

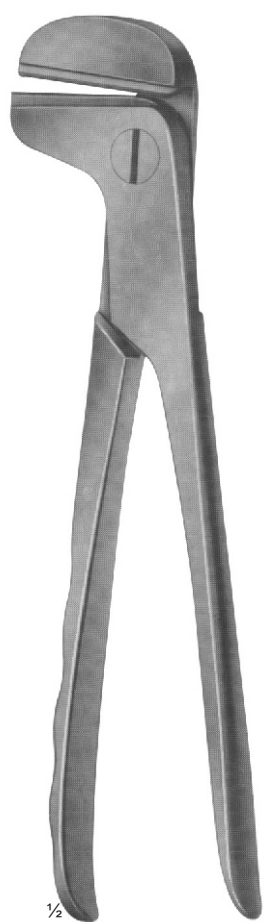

JJ-19-544
240 mm

for soft wire
up to diam. 2 mm
For hard wire
up to diam. 1.6 mm

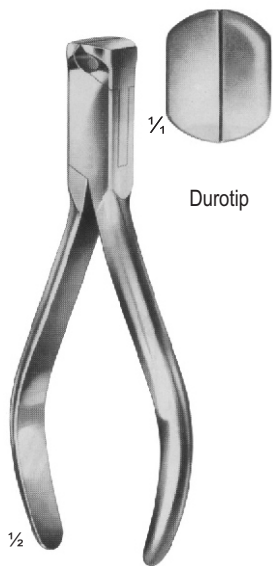

JJ-19-545
140 mm

for soft wire
up to diam. 1.5 mm
For hard wire
up to diam. 1 mm

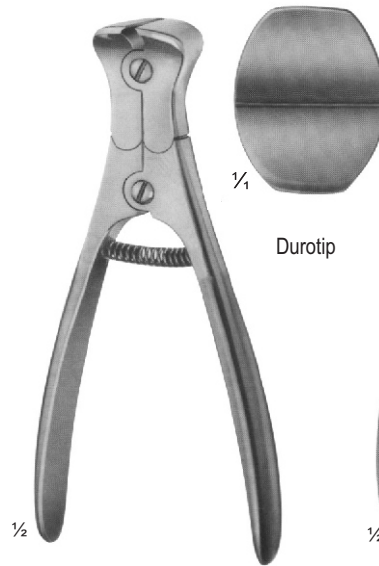

JJ-19-546
145 mm

for soft wire
up to diam. 2 mm
For hard wire
up to diam. 1.5 mm

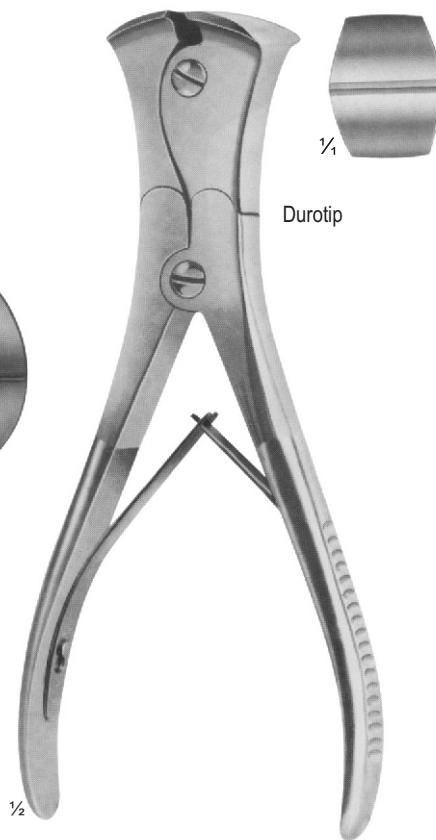

JJ-19-547
220 mm

for soft wire
up to diam. 3.5 mm
For hard wire
up to diam. 2.5 mm



JJ-19-548
320 mm

for soft wire
up to diam. 3 mm
For hard wire
up to diam 3 mm

Cutter for cutting off
KIRSCHNER wires,
Tibia head screws,
bolts, pins, up to 3 mm diam.



Durotip

JJ-19-549
Cutter for cutting off
KIRSCHNER wires,
Tibia head screws,
bolts, pins, up to 6 mm diam.
470 mm

TENDON STRIPPERS

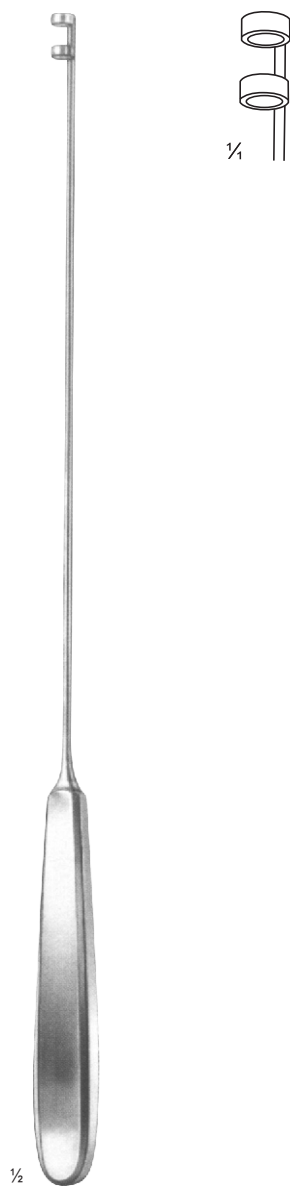

FISCHER
JJ-19-550
310 mm
Blunt

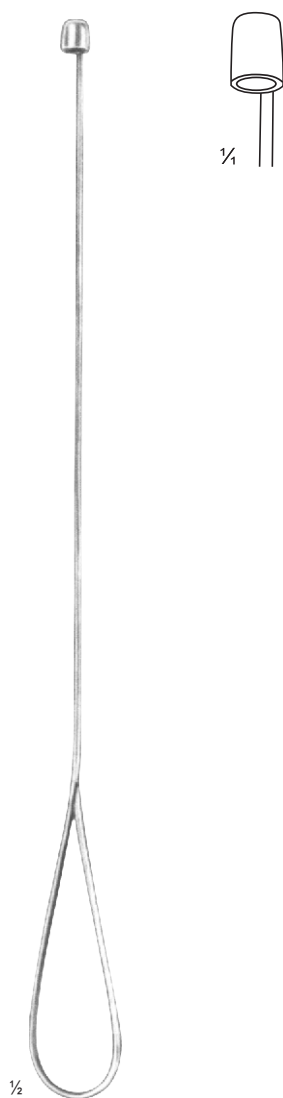

JJ-19-551
285 mm

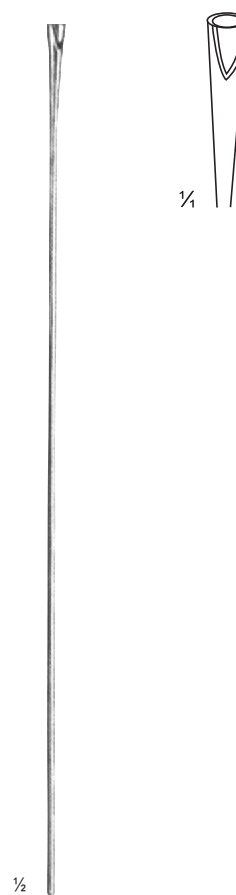

BUNNELL
JJ-19-552
230 mm
Tendon Passer

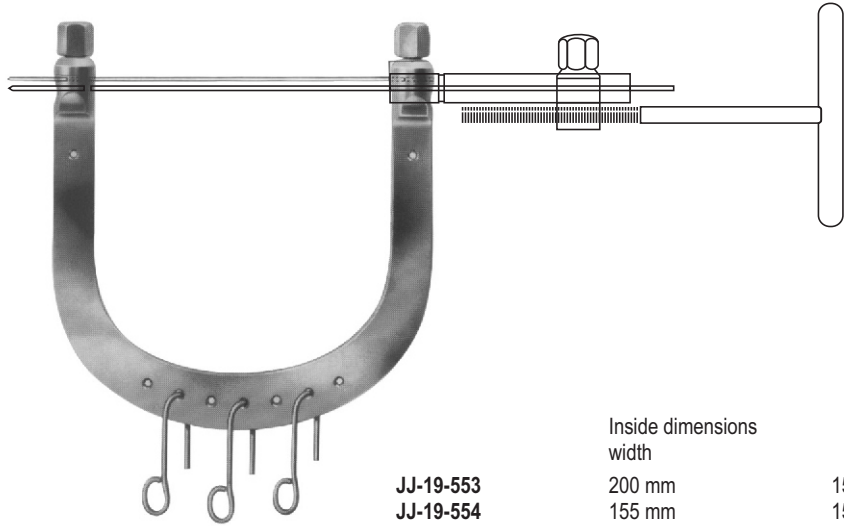

KIRSCHNER
JJ-19-553 - JJ-19-559
Wire traction bows,
to be used with
KIRSCHNER-wires
up to 2.5 mm diam.,
With 3 hooks,
stainless steel

- JJ-19-553**
- JJ-19-554**
- JJ-19-555**
- JJ-19-556**
- JJ-19-557**
- JJ-19-558**
- JJ-19-559**

Inside dimensions width	Depth
200 mm	155 mm
155 mm	155 mm
135 mm	130 mm
120 mm	120 mm
105 mm	100 mm
95 mm	110 mm
95 mm	70 mm



JJ-19-560
Wrench, double - ended,
for wire traction bows



JJ-19-561
Wire tightener, with
clamping jaws



1/3

JJ-19-562
Traction hook only,
large size



1/3

JJ-19-563
Traction hook only,
small size

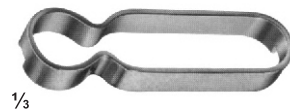

1/3

JJ-19-564
Fixation clamp, to secure clamping
jaws of stainless steel

WIRE EXTENSION

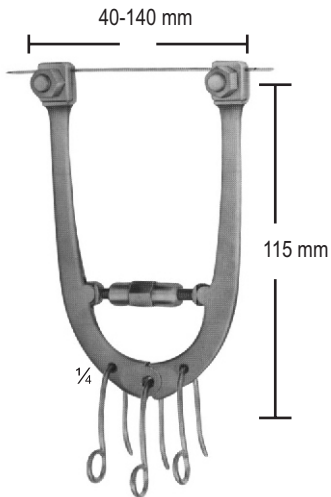

JJ-19-565
Wire traction bow, adjustable,
with 3 hooks, small size

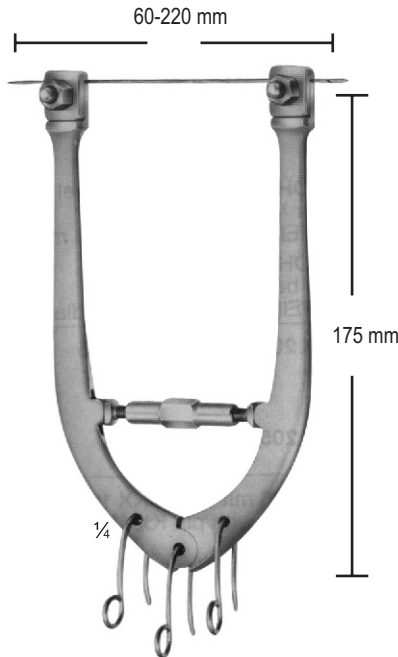

JJ-19-566
Wire traction bow, adjustable,
with 3 hooks, large size

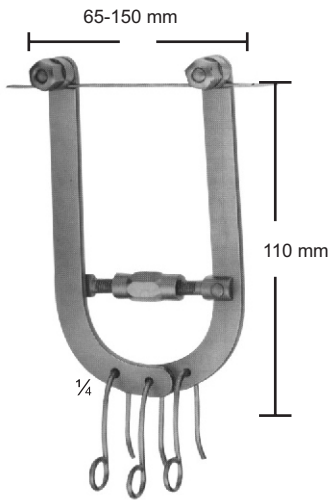

JJ-19-567
Wire traction bow, adjustable,
with 3 hooks, large size for
elbow and calcaneus, for
adolescents

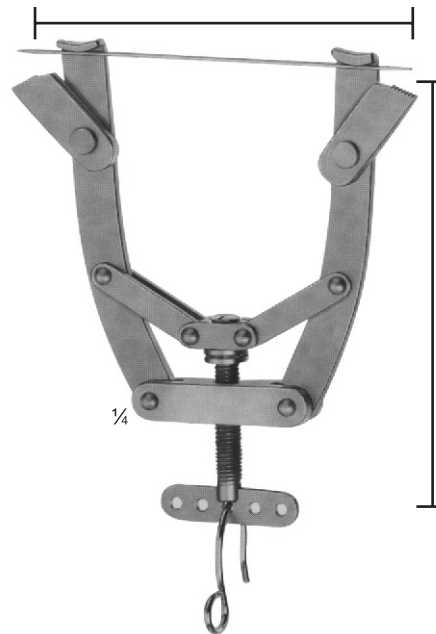

KIRSCHNER
JJ-19-570 - JJ-19-575
Wire traction bow, modified
adjustable in with width, holds
securely, with 1 hook

- JJ-19-570 10 cm
- JJ-19-571 16 cm
- JJ-19-572 20 cm

- JJ-19-573 1.6 mm
- JJ-19-574 2 mm
- JJ-19-575 2.5 mm



JJ-19-568
Fixation disc, slotted



JJ-19-569
idem, aluminum, transparent
to X-rays

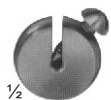

JJ-19-576
Fixation disc, slotted



JJ-19-577
Screw driver, for above
fixations discs

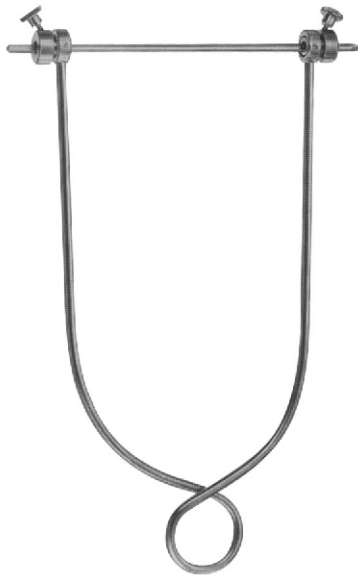

JJ-19-578 - JJ-19-585
Screw driver, for above
fixations discs

Steinmann pins, 4 mm daim.	Steinmann pins, 5 mm daim.
JJ-19-578 with pin	16x9cm Arm
JJ-19-579 without pin	JJ-19-580-00 without
JJ-19-581 with pin	21x11cm Arm
JJ-19-582 without pin	JJ-19-583 without
JJ-19-584 with pin	21x15cm Arm
JJ-19-585 without pin	



JJ-19-586
SCHWARZ
Traction bow for fingers,
to be used with KIRSCHNER-
wire up to 1.6 mm diam.

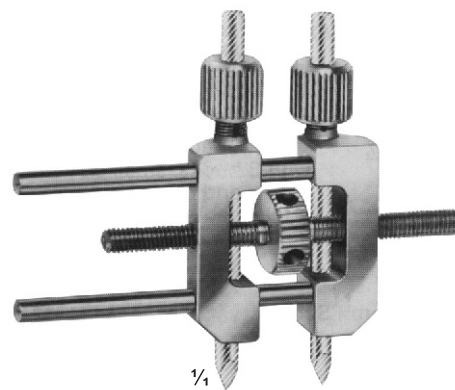

JJ-19-587
Small distractor
as a repositioning device for
distraction and compression of small bones,
for wires with 3 mm diam.

10-40 mm

STEINMANN PINS



STEINMANN
JJ-19-588 - JJ-500
 triangular shaft ended
 and trocar point

Length	4 mm	5 mm
80 mm	JJ-19-588	
100 mm	JJ-19-589	
120 mm	JJ-19-590	
140 mm	JJ-19-591	
150 mm	JJ-19-592	JJ-19-593
160 mm	JJ-19-594	
180 mm	JJ-19-595	JJ-19-596
200 mm	JJ-19-597	JJ-19-598
210 mm	JJ-19-599	
250 mm	JJ-19-600	JJ-19-601
300 mm		JJ-19-602



JJ-19-603
 Protection cap
 for 4 mm STEINMANN Pins

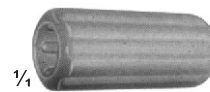

JJ-19-604
 Protection cap
 for 5 mm STEINMANN Pins



REILL
JJ-19-605
Drilling chuck, cannulated, for shanks from 2.0 - 2.5 mm diam 115 mm

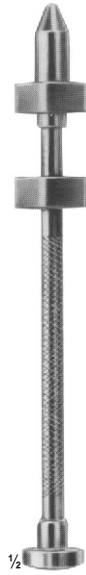

JJ-19-606
Drilling chuck, cannulated, for shanks from 0.8 - 2.0 mm diam 150 mm



JJ-19-607
Drilling chuck, cannulated, for shanks up to 4.5 mm diam with key 140 mm



LOUTE
JJ-19-608
Wire tightener, improved pattern, with movable tip, for wires up to 1.0 mm diam. 220 mm



JJ-19-609
Drilling chuck, cannulated, for shanks up to 6.35 mm diam., To be tightened by hand 100 mm



JJ-19-610
Drilling chuck, cannulated, for shanks up to 4.5 mm diam., And for triangular shaft width across flats 4.7 mm



JJ-19-611
Drilling chuck, cannulated, for shanks up to 6.35 mm diam., With key 160 mm

FINGER NAIL INSTRUMENTS

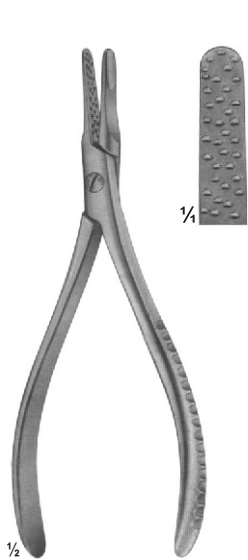

JJ-19-612
Nail extracting
forceps
135 mm

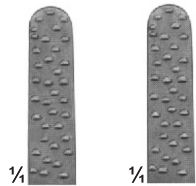

JJ-19-613
Nail extracting
forceps
145 mm

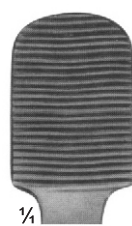

MARTIN-IDEAL
JJ-19-614 - JJ-19-616
Finger nail drill
with 3 points

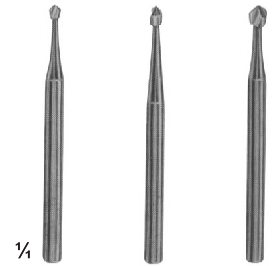

JJ-19-614 JJ-19-615 JJ-19-616

Drill points only

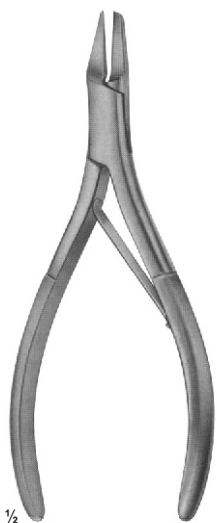

JJ-19-617
Nail splitting
forceps
135 mm

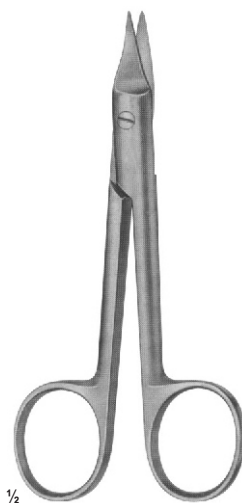
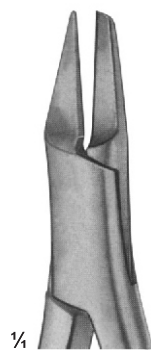

SYSTRUNK
JJ-19-618
Scissors, for splitting
finger nails
130 mm

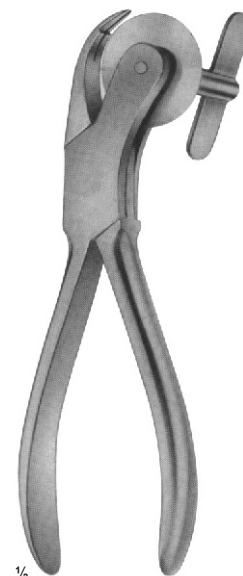

JJ-19-619
Finger ring saw
150 mm

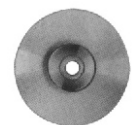

Spare blade

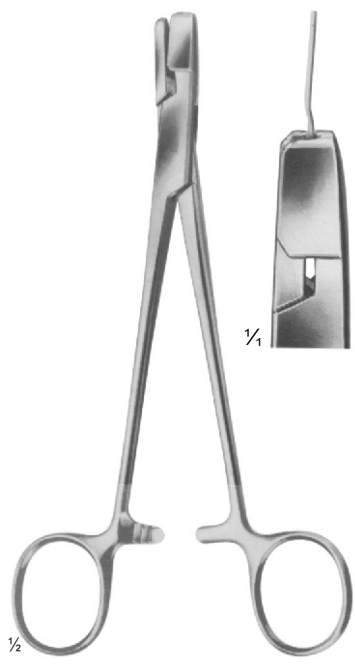

**DUROGRIP
JJ-19-620**
Holding forceps for cerclage
wire, with lateral jaws to avoid
wire slipping off
170 mm



**DUROGRIP
JJ-19-621**
Wire, tightening pliers,
Ligature pliers
150 mm



**DUROGRIP
JJ-19-622**
Wire, tightening pliers,
Ligature pliers
150 mm

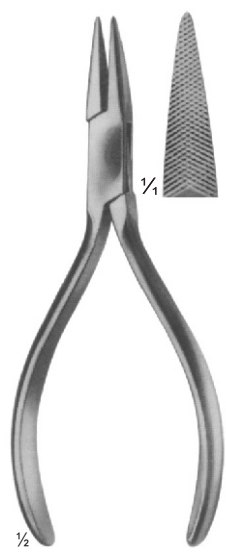

JJ-19-623
with serrated jaws
140 mm

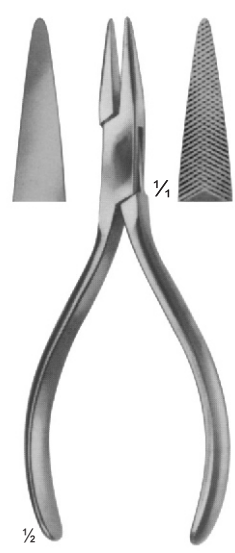

JJ-19-624
one jaws smooth,
one jaws serrated
140 mm



JJ-19-625
with serrated jaws
JJ-19-626
with longitudinal and
transversal grooves
170 mm

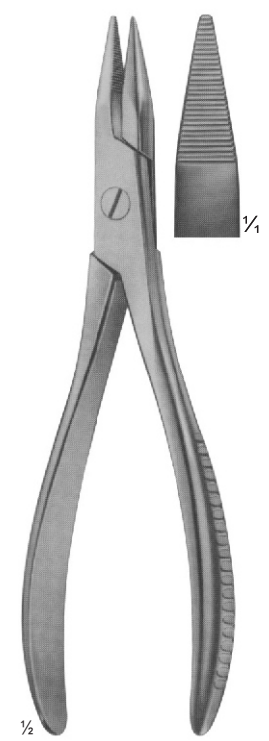

JJ-19-627
190 mm



Durotip

JJ-19-628
Cutter for cutting off
KIRSCHNER wires,
Tibia head screws,
bolts, pins, up to 6 mm diam.
47 cm



JJ-19-629
For Soft Wire \varnothing cm 3.5
For Hars Wire \varnothing cm 2.5
22 cm



JJ-19-630
For Soft Wire \varnothing cm 2.0
For Hars Wire \varnothing cm 1.5
22 cm

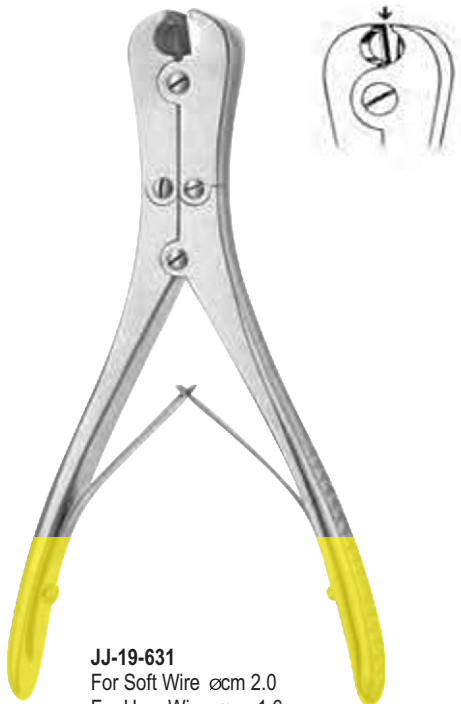

JJ-19-631
For Soft Wire \varnothing cm 2.0
For Hars Wire \varnothing cm 1.6
18 cm



JJ-19-632
17 cm

Page 464-470

- Plaster Instruments

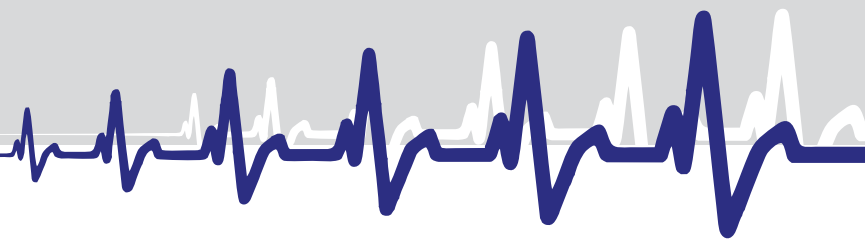

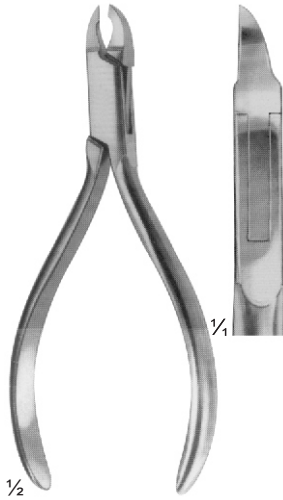

JJ-20-101
ANGLE
130 mm

JJ-20-102
DUROTIP
ANGLE
130 mm

for soft wire up to diam.	0,5 mm	0,6 mm
for hard wire up to diam.	0,3 mm	0,4 mm

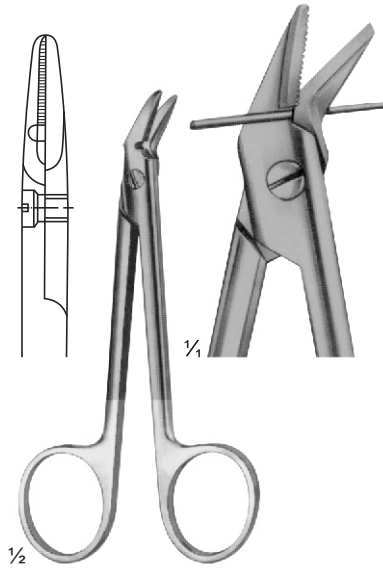

JJ-20-103
120 mm

JJ-20-104
DUROTIP
120 mm

for soft wire up to diam.	1,2 mm	1,2 mm
for hard wire up to diam.	0,8 mm	0,8 mm

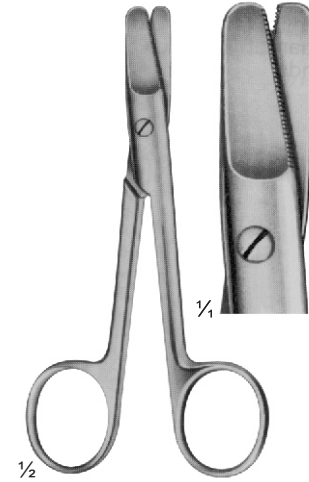

JJ-20-105
HARVEY
125 mm

0,4 mm
0,3 mm

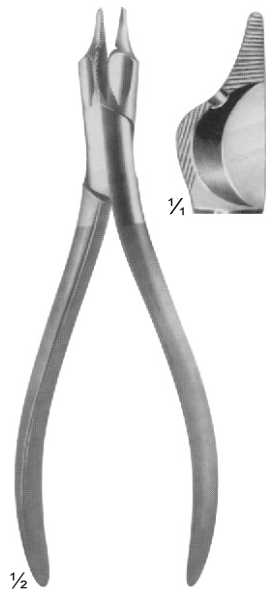

JJ-20-106
150 mm

for soft wire up to diam	1,5 mm
for hard wire up to diam	1,0 mm



JJ-20-107
160 mm

1,5 mm
1,2 mm



JJ-20-108
140 mm

1,5 mm
1,0 mm

WIRE CUTTING PLIERS, LATERAL CUTTING ACTION

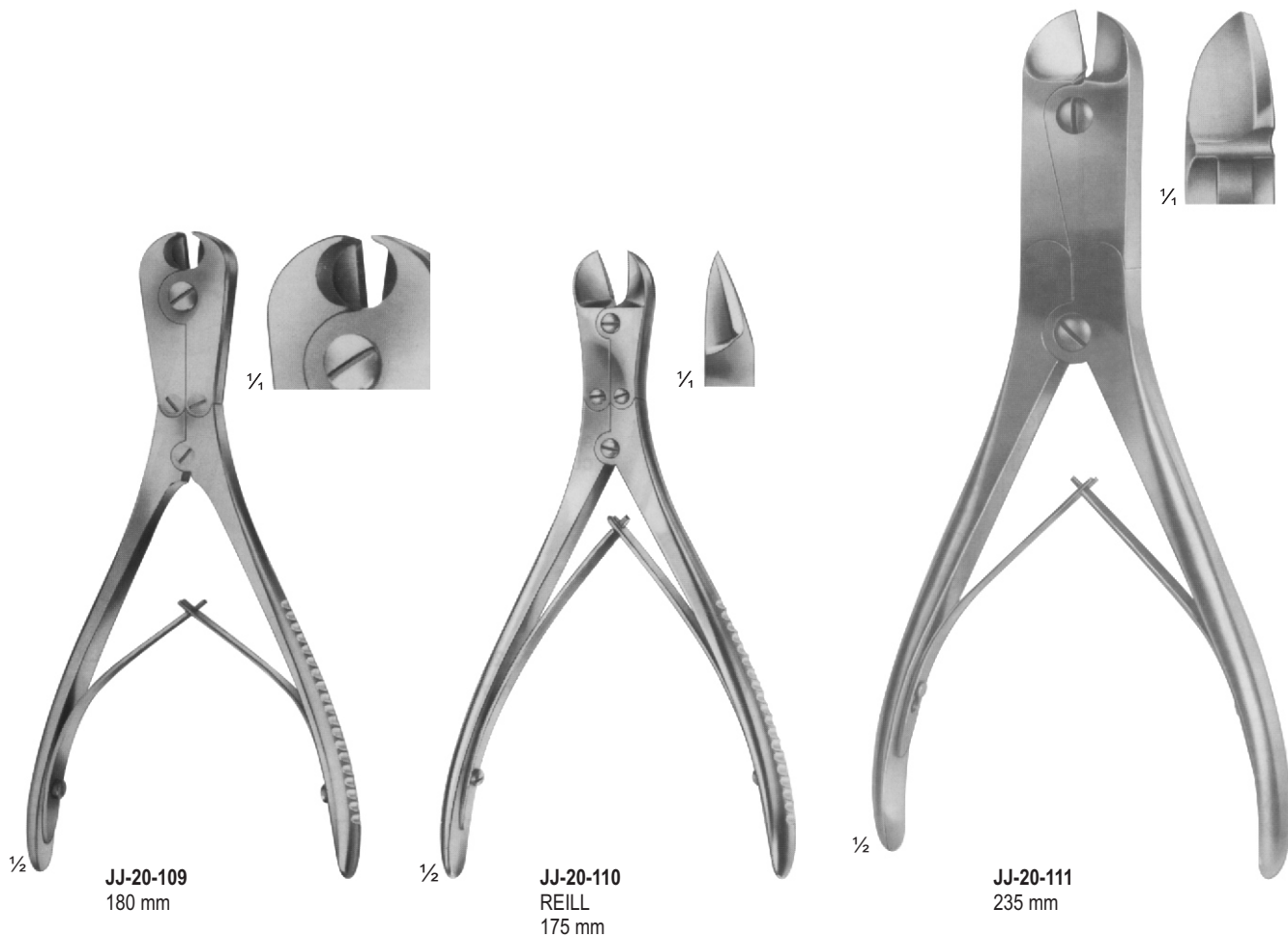

JJ-20-109
180 mm

for soft wire
up to diam. 2,0 mm
For hard wire 1,5 mm
up to diam
specially hardened
cutting edges, front
and lateral cutting
action

JJ-20-110
REILL
175 mm

for soft wire
up to diam. 2,0 mm
For hard wire 1,6 mm
up to diam
specially hardened
cutting edges, for
cutting off wires close
to the bone

JJ-20-111
235 mm

for soft wire
up to diam. 3,0 mm
For hard wire 2,2 mm
up to diam



KILLIAN
JJ-20-112
200 mm



JJ-20-113 - JJ-20-114
JJ-20-113 195 mm
JJ-20-114 225 mm



LEBSCHE
JJ-20-115
Sternum chisel
200 mm



JJ-20-116
230 mm



COLLIN
JJ-20-117
195 mm

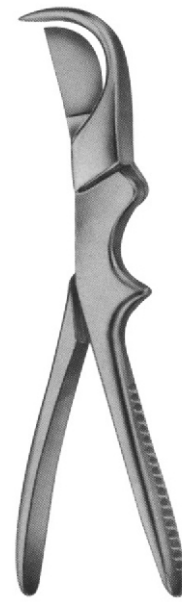

GLUCK
JJ-20-118
190 mm

PLASTER SHEARS

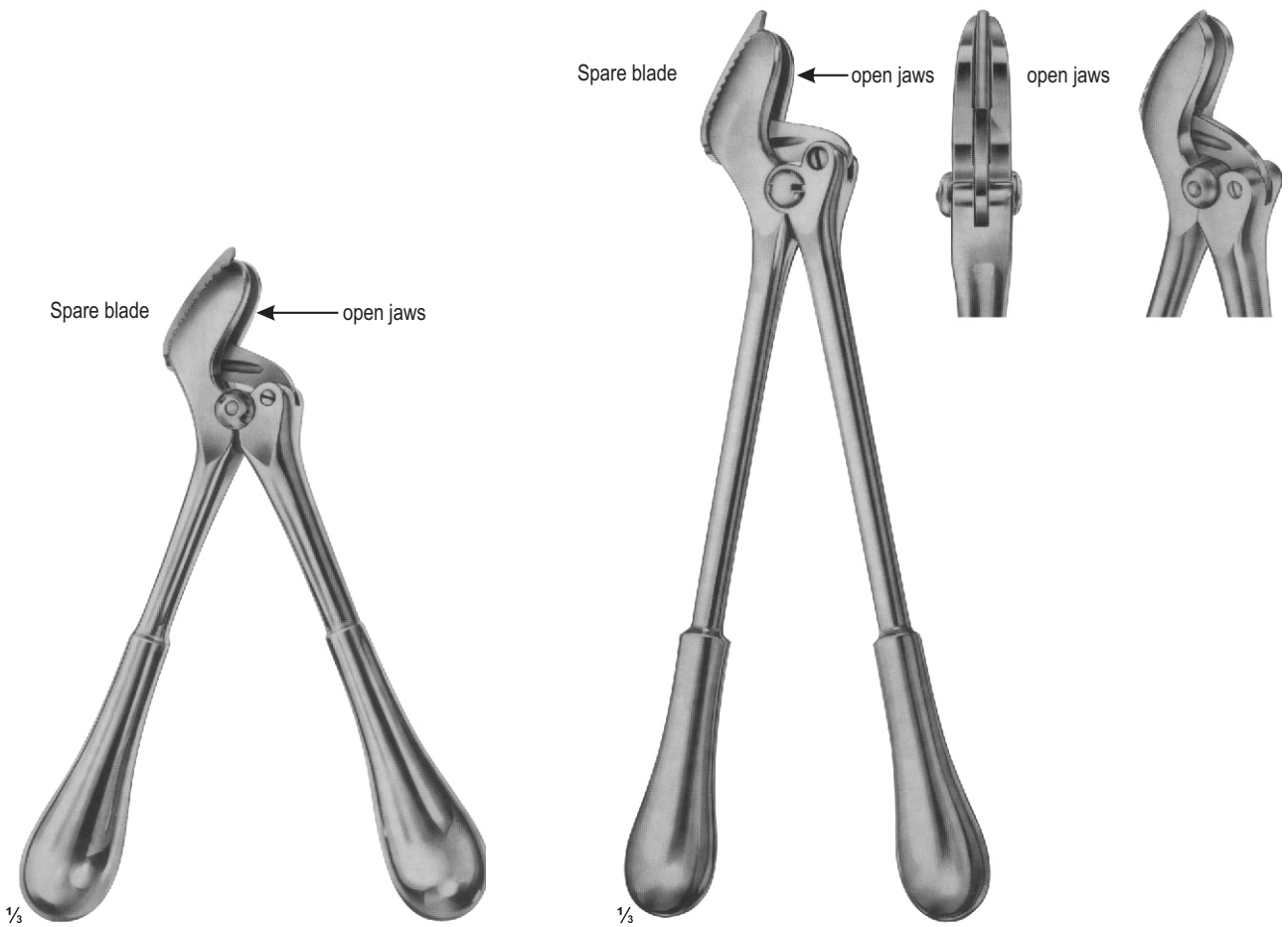

JJ-20-119
STILLE-AESULAP
260 mm

JJ-20-120
STILLE-AESULAP
360 mm

Blade with reinforced back



JJ-20-121
STILLE
230 mm

JJ-20-122
Spare blade



JJ-20-123
STILLE
370 mm

JJ-20-124
Spare blade

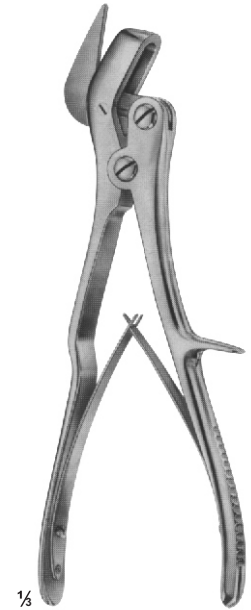

JJ-20-125
STILLE
240 mm

JJ-20-126
Spare blade



BEESON
JJ-20-127
30 cm



MOD.USA
JJ-20-128
23 cm



HAGLUND-STILLE
JJ-20-129
20 cm

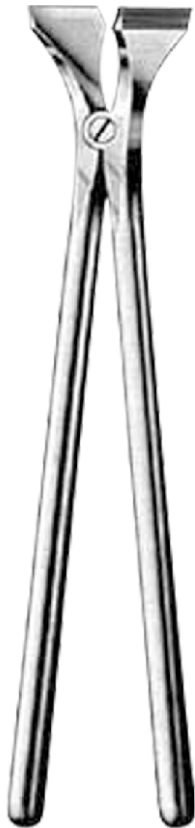

JJ-20-130
29 cm

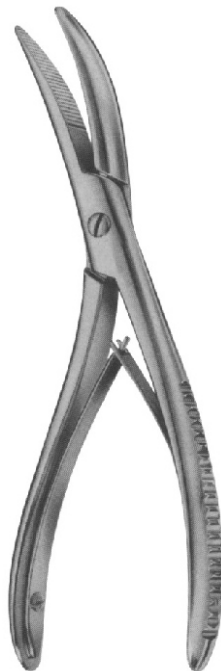

WOLFF
JJ-20-131
10 cm



WOLFF
JJ-20-132
24 cm

Page 471-499

- NeuroSurgery
- Laminectomy

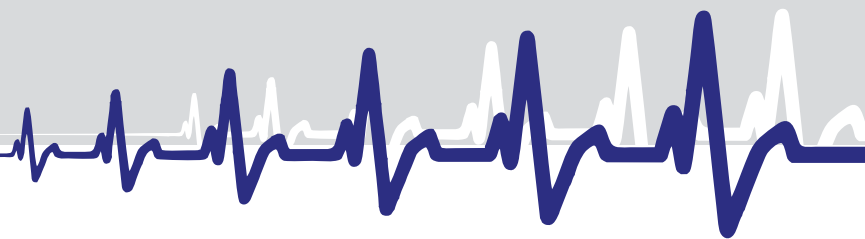



WAGENER
JJ-21-101 - JJ-21-104
150 mm



GRAEFE
JJ-21-105 - JJ-21-107
140 mm



BROM
JJ-21-108
Vein hook
170 mm



CRILE
JJ-21-109
200 mm



CUSHING
JJ-21-110- JJ-21-111
190 mm

NERVE HOOKS

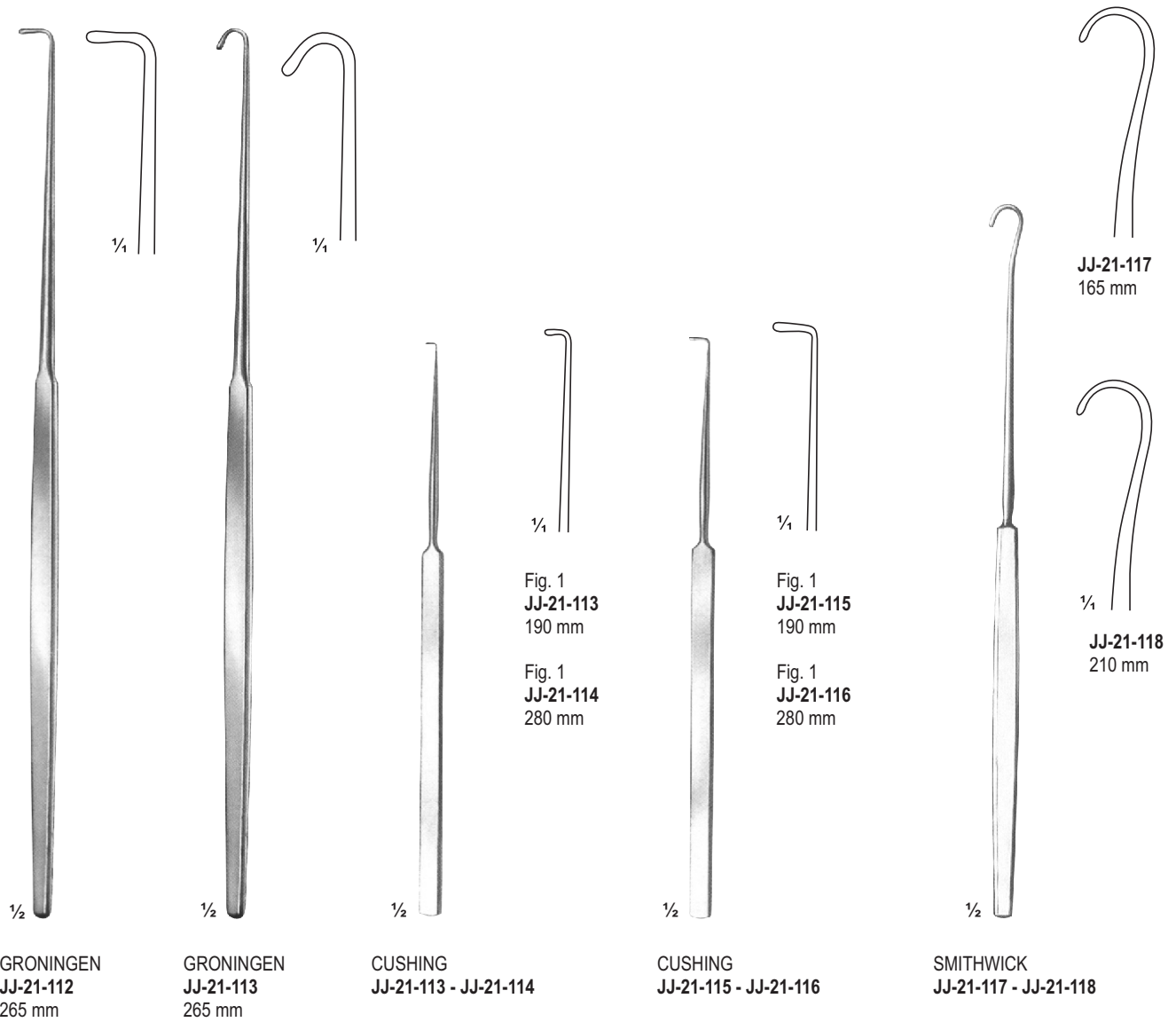



1/2

KRAYENBUHI
JJ-21-119 - JJ-21-122
190 mm



Fig.1
JJ-21-119



Fig.2
JJ-21-120



Fig.1
JJ-21-121



Fig.2
JJ-21-122



1/2

CASPER
JJ-21-123 - JJ-21-126
245 mm



JJ-21-123



JJ-21-124



JJ-21-125



JJ-21-126

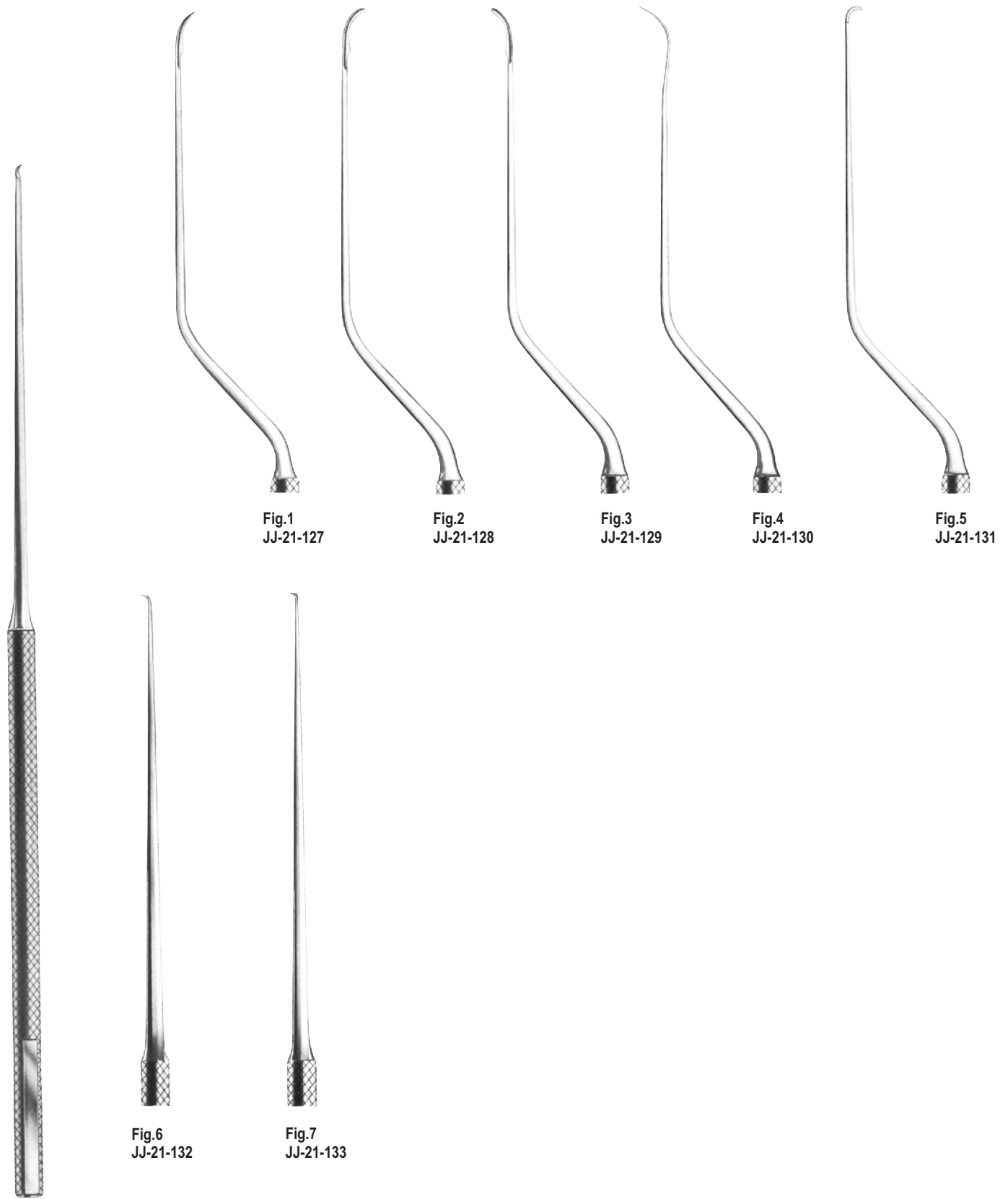

JJ-21-127 - JJ-21-133

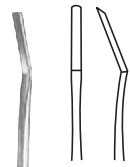

YASARGIL
JJ-21-134
190 mm

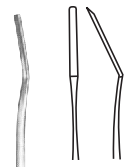

YASARGIL
JJ-21-135
190 mm

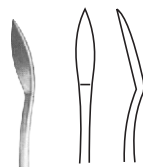

YASARGIL
JJ-21-136
190 mm



YASARGIL
JJ-21-137
190 mm

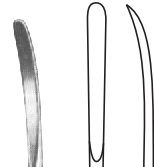

YASARGIL
JJ-21-138
190 mm

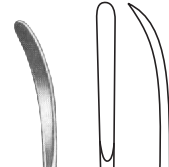

YASARGIL
JJ-21-139
190 mm

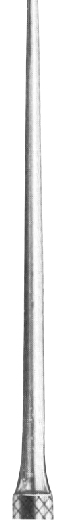

JACOBSON
JJ-21-140
190 mm

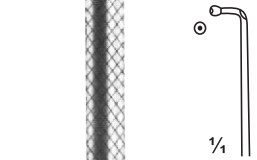
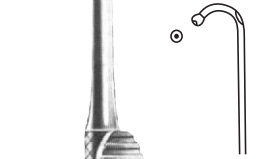
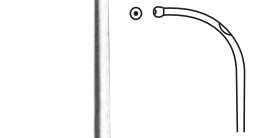
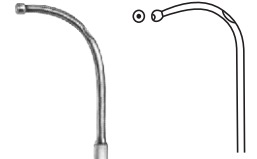

JACOBSON
JJ-21-141
190 mm



YASARGIL
JJ-21-142
190 mm



JJ-21-143
190 mm

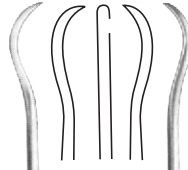

JJ-21-144
190 mm

YASARGIL



JJ-21-145
190 mm



JJ-21-146
190 mm

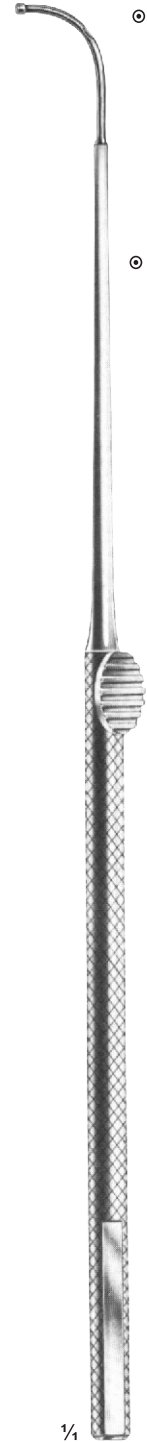

YASARGIL
JJ-21-JJ-21-147
190 mm

DURA DISSECTORS



YASARGIL
JJ-21-148 - JJ-21-149
Galea Hook

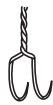

JJ-21-148
300 mm



1/4
JJ-21-149
410 mm

1/2



TOENNIS
JJ-21-150
240 mm



1/4



OLIVECRONA
JJ-21-151
240 mm



1/2



1/4



HESS
Nerve Root Retractor
JJ-21-152 - JJ-21-154
JJ-21-152 175 mm 3 mm
JJ-21-153 175 mm 5 mm
JJ-21-154 175 mm 7 mm

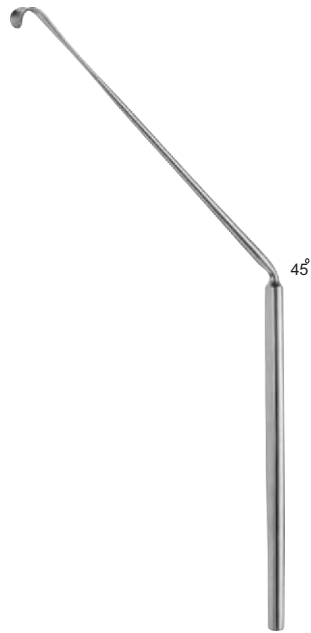

LOVE
Nerve Root Retractor
JJ-21-155 - JJ-21-157
JJ-21-155 190 mm 30°
JJ-21-156 190 mm 45°
JJ-21-157 190 mm 90°



CASPAR
Nerve Root Retractor
JJ-21-158 - JJ-21-160
JJ-21-158 245 mm 6 mm
JJ-21-159 245 mm 8 mm
JJ-21-160 245 mm 10 mm



LOVE
JJ-21-161
210 mm

NERVE ROOT RETRACTORS



SCOVILLE
JJ-21-162
235 mm

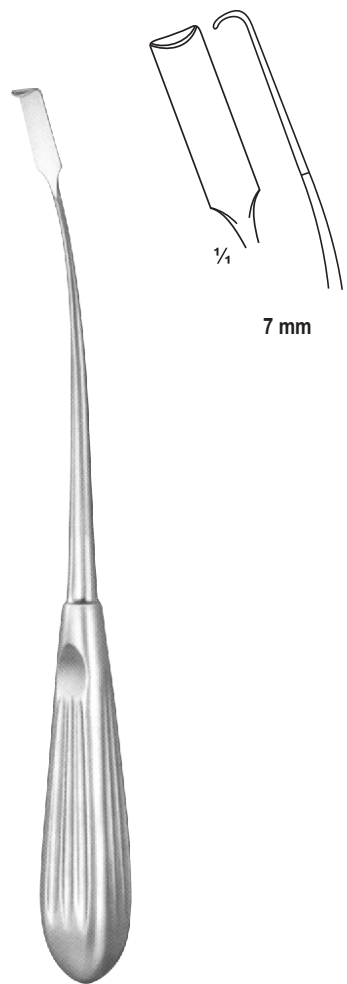

HOLSHER
JJ-21-163
240 mm

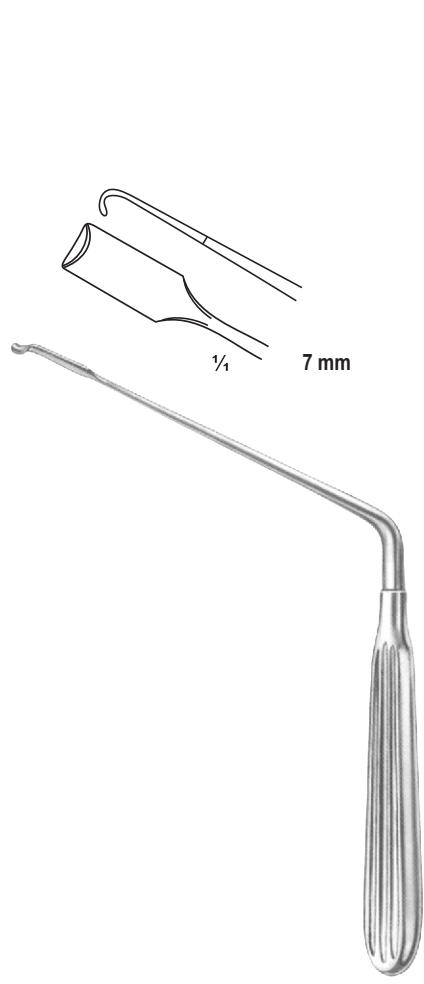

SCOVILLE
JJ-21-164
165 mm



LEYLA
JJ-21-165
Self-Retaining brain retractor
with 2 arms complete

LEYLA BED RETRACTOR
JJ-21-166
Self-Retaining brain retractor
bed retractor not illustrated

BRAIN SPATULAS

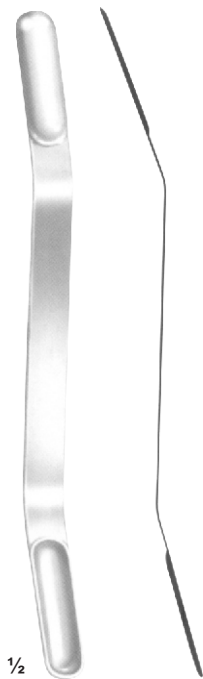

OLIVECRONA
JJ-21-167 - JJ-21-170
 180 mm
 Concave

JJ-21-167 7 + 9 mm
JJ-21-168 11 + 13 mm
JJ-21-169 15 + 18 mm
JJ-21-170 18 + 22 mm



JJ-21-171
 15.5 cm
 11 mm

JJ-21-172
 20 cm
 14 mm

JJ-21-173
 20 cm
 17 mm

JJ-21-174
 20 cm
 20 mm

HEIFETZ
JJ-21-171 - JJ-21-174

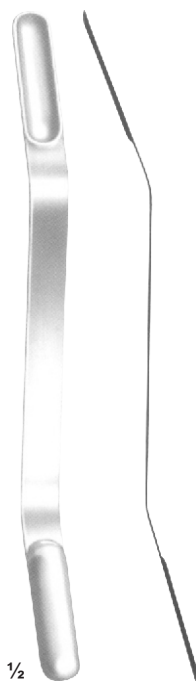

OLIVECRONA
JJ-21-175 - JJ-21-178
 180 mm
 Convex

JJ-21-175 7 + 9 mm
JJ-21-176 11 + 13 mm
JJ-21-177 15 + 18 mm
JJ-21-178 18 + 22 mm



JJ-21-179
 8 mm

JJ-21-180
 14 mm

JJ-21-181
 17 mm

HEIFETZ
JJ-21-179 - JJ-21-181
 155 mm



CASPAR JJ-21-182
Transverse Retractor hinged
65 mm regular spread
110 mm wide spread



CASPAR JJ-21-183
Transverse Retractor double-hinged
65 mm spread



CASPAR JJ-21-184
Longitudinal Retractor
double-hinged, ring handle
205 mm
85 mm spread

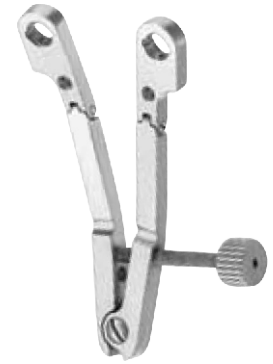

CASPAR JJ-21-185
Specula Retractor single-hinged,
115 mm
70mm regular spread



JJ-21-186 - JJ-21-194
JJ-21-187 23 x 35 mm
JJ-21-188 23 x 40 mm
JJ-21-189 23 x 45 mm
JJ-21-190 23 x 50 mm
JJ-21-191 23 x 55 mm
JJ-21-192 23 x 60 mm
JJ-21-193 23 x 65 mm
JJ-21-194 23 x 70 mm
Medial Toothed Blades
Stainless Steel



JJ-21-195 - JJ-21-199
JJ-21-195 15 x 40 mm
JJ-21-196 15 x 45 mm
JJ-21-197 15 x 50 mm
JJ-21-198 15 x 55 mm
JJ-21-199 15 x 60 mm
Small Lateral Blades
Stainless Steel



JJ-21-200 - JJ-21-206
JJ-21-200 23 x 40 mm
JJ-21-201 23 x 45 mm
JJ-21-202 23 x 50 mm
JJ-21-203 23 x 55 mm
JJ-21-204 23 x 60 mm
JJ-21-205 23 x 65 mm
JJ-21-206 23 x 70 mm
Lateral Serrated Blades
Stainless Steel



Cervical Blades
Stainless Steel – fenestrated
JJ-21-207 - JJ-21-208
JJ-21-207 25 x 50 mm
JJ-21-208 25 x 60 mm



JJ-21-209 - JJ-21-217
JJ-21-209 23 x 35 mm
JJ-21-210 23 x 40 mm
JJ-21-211 23 x 45 mm
JJ-21-212 23 x 50 mm
JJ-21-213 23 x 55 mm
JJ-21-214 23 x 60 mm
JJ-21-215 23 x 65 mm
JJ-21-216 23 x 70 mm
JJ-21-217 23 x 75 mm
Blunt Blades
Stainless Steel



JJ-21-218 - JJ-21-222
JJ-21-218 23 x 40 mm
JJ-21-219 23 x 45 mm
JJ-21-220 23 x 50 mm
JJ-21-221 23 x 55 mm
JJ-21-222 23 x 60 mm
Medial Toothed Blades
Aluminium – rotatating



JJ-21-223 - JJ-21-227
JJ-21-223 23 x 40 mm
JJ-21-224 23 x 45 mm
JJ-21-225 23 x 50 mm
JJ-21-226 23 x 55 mm
JJ-21-227 23 x 60 mm
Lateral Serrated Blades
Aluminium – rotatating



JJ-21-228 - JJ-21-232
JJ-21-228 23 x 45 mm
JJ-21-229 23 x 50 mm
JJ-21-230 3 x 55 mm
JJ-21-231 23 x 60 mm
JJ-21-232 23 x 65 mm
Blunt Blades
Aluminium – rotatating

RETRACTORS FOR CERVICAL VERTEBRAL COLUMN



CASPAR
JJ-21-233
Transverse Retractor hinged
65 mm spread

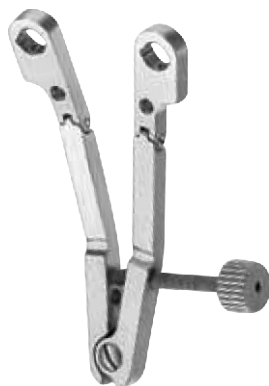

CASPAR
JJ-21-234
Specula Retractor single-hinged
115 mm,
70 mm spread



CASPAR
JJ-21-235
Longitudinal Retractor
single-hinged ring handle
175 mm
70 mm spread



JJ-21-236 - JJ-21-243
JJ-21-236 20 x 40 mm
JJ-21-237 20 x 45 mm
JJ-21-238 20 x 50 mm
JJ-21-239 20 x 55 mm
JJ-21-240 20 x 60 mm
JJ-21-241 20 x 65 mm
JJ-21-242 20 x 70 mm
JJ-21-243 20 x 75 mm
Medial Toothed Blades



JJ-21-244 - JJ-21-254
JJ-21-244 20 x 25 mm
JJ-21-245 20 x 30 mm
JJ-21-246 20 x 35 mm
JJ-21-247 20 x 40 mm
JJ-21-248 20 x 45 mm
JJ-21-249 20 x 50 mm
JJ-21-250 20 x 55 mm
JJ-21-251 20 x 60 mm
JJ-21-252 20 x 65 mm
JJ-21-253 20 x 70 mm
JJ-21-254 20 x 75 mm
Lateral Serrated Blades



JJ-21-255 - JJ-21-264
JJ-21-255 20 x 30 mm
JJ-21-256 20 x 35 mm
JJ-21-257 20 x 40 mm
JJ-21-258 20 x 45 mm
JJ-21-259 20 x 50 mm
JJ-21-260 20 x 55 mm
JJ-21-261 20 x 60 mm
JJ-21-262 20 x 65 mm
JJ-21-263 20 x 70 mm
JJ-21-264 20 x 75 mm
Blunt Blades



JJ-21-265 - JJ-21-272
JJ-21-265 20 x 35 mm
JJ-21-266 20 x 40 mm
JJ-21-267 20 x 45 mm
JJ-21-268 20 x 50 mm
JJ-21-269 20 x 55 mm
JJ-21-270 20 x 60 mm
JJ-21-271 20 x 65 mm
JJ-21-272 0 x 70 mm
Medial Toothed Blades
fenestrated



JJ-21-273 - JJ-21-282
JJ-21-273 20 x 25 mm
JJ-21-274 20 x 30 mm
JJ-21-275 20 x 35 mm
JJ-21-276 20 x 40 mm
JJ-21-277 20 x 45 mm
JJ-21-278 20 x 50 mm
JJ-21-279 20 x 55 mm
JJ-21-280 20 x 60 mm
JJ-21-281 20 x 65 mm
JJ-21-282 20 x 70 mm
Lateral Serrated Blades
Fenestrated



JJ-21-283 - JJ-21-291
JJ-21-283 20 x 35 mm
JJ-21-284 20 x 40 mm
JJ-21-285 20 x 45 mm
JJ-21-286 20 x 50 mm
JJ-21-287 20 x 55 mm
JJ-21-288 20 x 60 mm
JJ-21-289 20 x 65 mm
JJ-21-290 20 x 70 mm
JJ-21-291 20 x 75 mm
Blunt Blades Fenestrated



CASPAR
JJ-21-292
Transverse Retractor hinged
60 mm spread



CASPAR
JJ-21-293
Transverse Retractor double-hinged
65 mm spread



CASPAR
JJ-21-294
Longitudinal Retractor
single-hinged ring handle
175 mm
70 mm spread



CASPAR
JJ-21-295
Longitudinal Retractor
single-hinged ring handle
175 mm
70 mm spread

RETRACTORS FOR CERVICAL VERTEBRAL COLUMN



JJ-21-296 - JJ-21-302
 JJ-21-296 12 x 40 mm
 JJ-21-297 12 x 45 mm
 JJ-21-298 12 x 50 mm
 JJ-21-299 12 x 55 mm
 JJ-21-300 12 x 60 mm
 JJ-21-301 12 x 65 mm
 JJ-21-302 12 x 75 mm
 Small Lateral Serrated
 Blades PEEK



JJ-21-303 - JJ-21-309
 JJ-21-303 23 x 40 mm
 JJ-21-304 23 x 45 mm
 JJ-21-305 23 x 50 mm
 JJ-21-306 23 x 55 mm
 JJ-21-307 23 x 60 mm
 JJ-21-308 23 x 65 mm
 JJ-21-309 23 x 75 mm
 Lateral Serrated Blades
 PEEK



JJ-21-310 - JJ-21-316
 JJ-21-310 23 x 40 mm
 JJ-21-311 23 x 45 mm
 JJ-21-312 23 x 50 mm
 JJ-21-313 23 x 55 mm
 JJ-21-314 23 x 60 mm
 JJ-21-315 23 x 65 mm
 JJ-21-316 23 x 75 mm
 Blunt Blades PEEK



JJ-21-317 - JJ-21-323
 JJ-21-317 23 x 40 mm
 JJ-21-318 23 x 45 mm
 JJ-21-319 23 x 50 mm
 JJ-21-320 23 x 55 mm
 JJ-21-321 23 x 60 mm
 JJ-21-322 23 x 65 mm
 JJ-21-323 23 x 75 mm
 Medial Toothed Blades
 PEEK



JJ-21-324 - JJ-21-330
 JJ-21-324 23 x 40 mm
 JJ-21-325 23 x 45 mm
 JJ-21-326 23 x 50 mm
 JJ-21-327 23 x 55 mm
 JJ-21-328 23 x 60 mm
 JJ-21-329 23 x 65 mm
 JJ-21-330 23 x 75 mm
 Lateral Serrated Blades
 PEEK – rotating



JJ-21-331 - JJ-21-337
 JJ-21-331 23 x 40 mm
 JJ-21-332 23 x 45 mm
 JJ-21-333 23 x 50 mm
 JJ-21-334 23 x 55 mm
 JJ-21-335 23 x 60 mm
 JJ-21-336 23 x 65 mm
 JJ-21-337 23 x 75 mm
 Blunt Blades
 PEEK – rotating

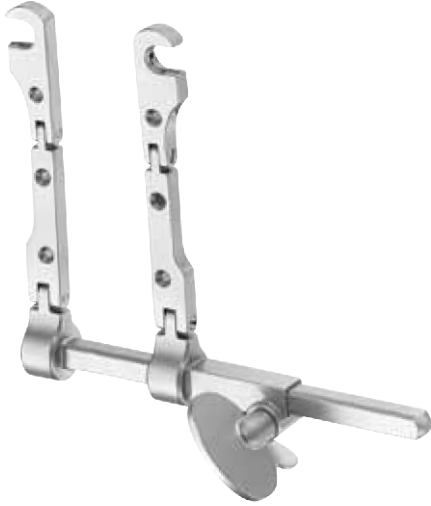

CASPAR
JJ-21-338
Transverse Retractor double-hinged
quick connect 72 mm spread, side-loading



CASPAR
JJ-21-339
Longitudinal Retractor double-hinged,
ring handle, quick connect
185 mm
75 mm spread, side-loading



CASPAR
JJ-21-340
Specula Retractor single-hinged,
quick connect
115 mm
70 mm spread, side-loading



CASPAR
JJ-21-341
Quick Connect Blade
Positioner Handle
210 mm
for quick connect
blades only



JJ-21-342 - JJ-21-346
JJ-21-342 23 x 40 mm
JJ-21-343 23 x 45 mm
JJ-21-344 23 x 50 mm
JJ-21-345 23 x 55 mm
JJ-21-346 23 x 60 mm
Medial Toothed Blades
Stainless Steel
quick connect



JJ-21-347 - JJ-21-351
JJ-21-347 23 x 40 mm
JJ-21-348 23 x 45 mm
JJ-21-349 23 x 50 mm
JJ-21-350 23 x 55 mm
JJ-21-351 23 x 60 mm
Lateral Serrated Blades
Stainless Steel
quick connect



JJ-21-352 - JJ-21-356
JJ-21-352 23 x 45 mm
JJ-21-353 23 x 50 mm
JJ-21-354 23 x 55 mm
JJ-21-355 23 x 60 mm
JJ-21-356 23 x 65 mm
Blunt Lateral Blades
Stainless Steel
quick connect



JJ-21-357 - JJ-21-361
JJ-21-357 23 x 40 mm
JJ-21-358 23 x 45 mm
JJ-21-359 23 x 50 mm
JJ-21-360 23 x 55 mm
JJ-21-361 23 x 60 mm
Medial Toothed Blades
Titanium
quick connect



JJ-21-362 - JJ-21-366
JJ-21-362 23 x 40 mm
JJ-21-363 23 x 45 mm
JJ-21-364 23 x 50 mm
JJ-21-365 23 x 55 mm
JJ-21-366 23 x 60 mm
Lateral Serrated Blades
Titanium
quick connect



JJ-21-367 - JJ-21-371
JJ-21-367 23 x 45 mm
JJ-21-368 23 x 50 mm
JJ-21-369 23 x 55 mm
JJ-21-370 23 x 60 mm
JJ-21-371 23 x 65 mm
Blunt Lateral Blades
Titanium
quick connect

RETRACTORS FOR CERVICAL VERTEBRAL COLUMN

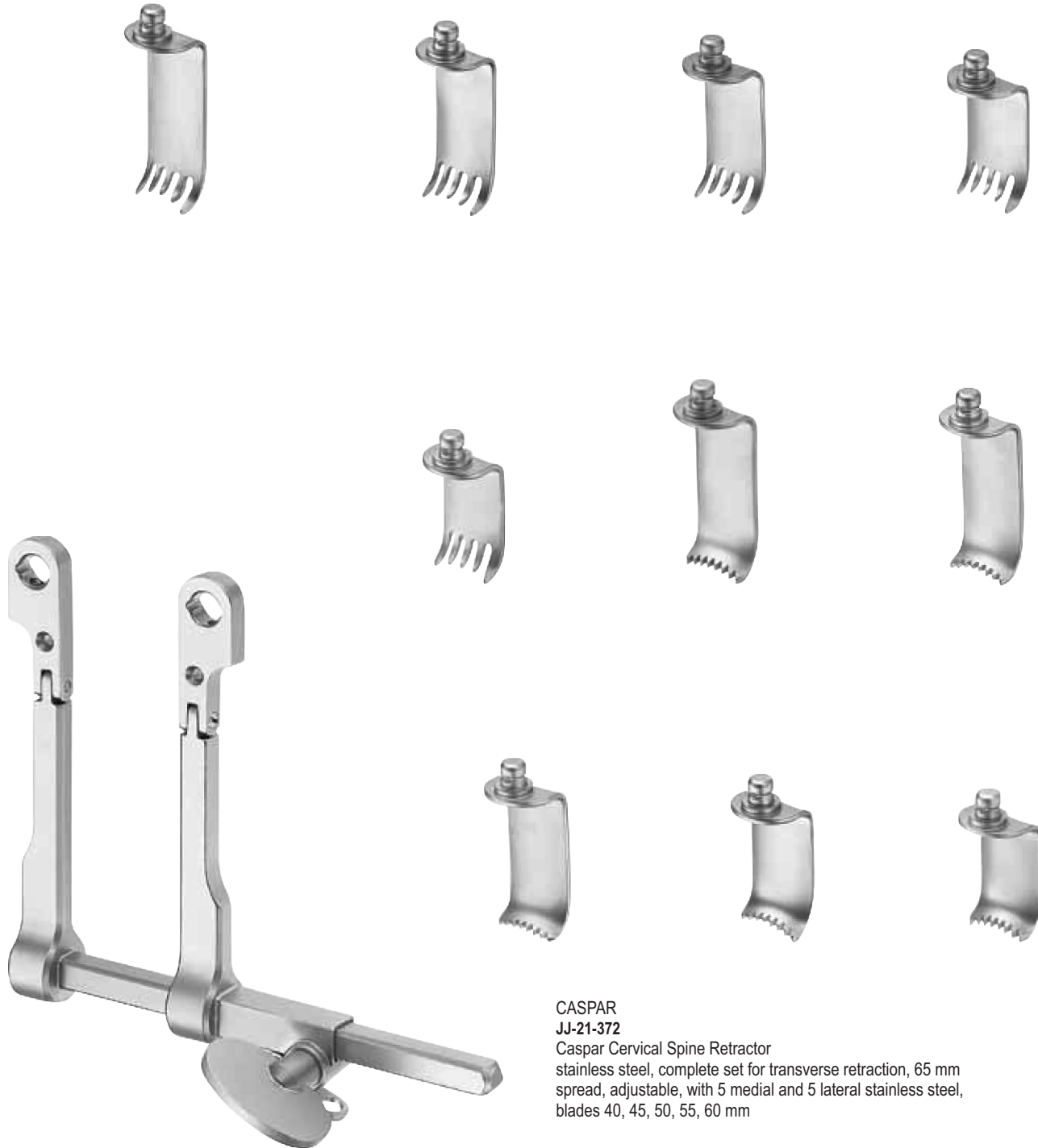

**CASPAR
JJ-21-372**

Caspar Cervical Spine Retractor
stainless steel, complete set for transverse retraction, 65 mm
spread, adjustable, with 5 medial and 5 lateral stainless steel,
blades 40, 45, 50, 55, 60 mm

JJ-21-373

TI Caspar Cervical Spine Retractor
titanium, complete set for transverse retraction, 65 mm
spread, adjustable, with 5 medial and 5 lateral titanium
blades 40, 45, 50, 55, 60 mm



CASPAR
JJ-21-374
Caspar Microdiscectomy Retractor
for microsurgical treatment of
herniated lumbar discs
45 mm spread



JJ-21-375 - JJ-21-383
JJ-21-375 35 mm
JJ-21-376 40 mm
JJ-21-377 45 mm
JJ-21-378 50 mm
JJ-21-379 55 mm
JJ-21-380 60 mm
JJ-21-381 65 mm
JJ-21-382 75 mm
JJ-21-383 85 mm
Lateral Blades



JJ-21-384 - JJ-21-390
JJ-21-384 40 mm
JJ-21-385 45 mm
JJ-21-386 50 mm
JJ-21-387 55 mm
JJ-21-388 60 mm
JJ-21-389 65 mm
JJ-21-390 70 mm
Paraspina Blades



CASPAR
JJ-21-391 - JJ-21-400
JJ-21-391 40 mm
JJ-21-392 45 mm
JJ-21-393 50 mm
JJ-21-394 55 mm
JJ-21-395 60 mm
JJ-21-396 65 mm
JJ-21-397 70 mm
JJ-21-398 75 mm
JJ-21-399 80 mm
JJ-21-400 85 mm
Lumbar Speculum
fenestrated

RETRACTORS FOR CERVICAL VERTEBRAL COLUMN



JJ-21-405 - JJ-21-410
JJ-21-405 20 x 30 mm
JJ-21-406 20 x 40 mm
JJ-21-407 20 x 50 mm
JJ-21-408 20 x 60 mm
JJ-21-409 20 x 70 mm
JJ-21-410 20 x 80 mm
 McCulloch 4-teeth
 Narrow Muscle Blades



JJ-21-411 - JJ-21-416
JJ-21-411 20 x 30 mm
JJ-21-412 20 x 40 mm
JJ-21-413 20 x 50 mm
JJ-21-414 20 x 60 mm
JJ-21-415 20 x 70 mm
JJ-21-416 20 x 80 mm
 McCulloch 6-teeth
 Wide Muscle Blades

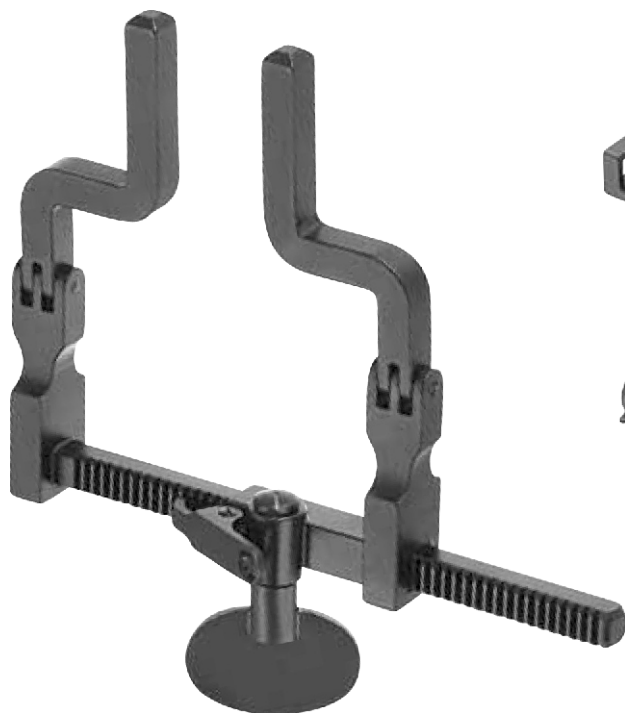

CASPAR
 McCulloch Lumbar Spine Retractor for Microdiscectomy,
 black silicone bead
JJ-21-401 68 mm spread, hinged
JJ-21-402 68 mm spread, rigid
JJ-21-403 90 mm spread, rigid
 McCulloch Lumbar Spine Retractor Tray
JJ-21-404 Tray 265 x 265 mm for Container (not illustrated)



JJ-21-417 - JJ-21-422
JJ-21-417 20 x 30 mm
JJ-21-418 20 x 40 mm
JJ-21-419 20 x 50 mm
JJ-21-420 20 x 60 mm
JJ-21-421 20 x 70 mm
JJ-21-422 20 x 80 mm
 McCulloch 2-teeth
 Thin Muscle Blades



JJ-21-423 - JJ-21-430
JJ-21-423 20 mm
JJ-21-424 30 mm
JJ-21-425 40 mm
JJ-21-426 50 mm
JJ-21-427 60 mm
JJ-21-428 70 mm
JJ-21-429 80 mm
JJ-21-430 90 mm
 McCulloch Hook Blades



JJ-21-431 - JJ-21-438
JJ-21-431 20 mm
JJ-21-432 30 mm
JJ-21-433 40 mm
JJ-21-434 50 mm
JJ-21-435 60 mm
JJ-21-436 70 mm
JJ-21-437 80 mm
JJ-21-438 90 mm
 McCulloch toothed
 Hook Blades



JJ-21-439 - JJ-21-441
JJ-21-439 20 x 50 mm
JJ-21-440 20 x 60 mm
JJ-21-441 20 x 70 mm
 McCulloch 2-teeth
 Cervical Blades



CASPAR
JJ-21-442 - JJ-21-443
Caspar Vertebral Column Retractor
for Laminectomy and Hemilaminectomy (Lumbar, Thoracic,
Cervical), stainless steel, complete set, 145 mm spread,
JJ-21-442 125 mm arms, consisting of
JJ-21-443 145 mm spread, hinged includes
Screw Driver for spreading bar



CASPAR
JJ-21-444
Screw driver four
spreading bar



CASPAR
JJ-21-445
Blade Changing Forceps
115 mm



JJ-21-446 - JJ-21-447
JJ-21-446 38 mm
JJ-21-447 58 mm



JJ-21-448 - JJ-21-455
JJ-21-448 22 x 32 mm
JJ-21-449 22 x 37 mm
JJ-21-450 22 x 43 mm
JJ-21-451 22 x 47 mm
JJ-21-452 22 x 52 mm
JJ-21-453 22 x 57 mm
JJ-21-454 22 x 62 mm
JJ-21-455 22 x 67 mm



JJ-21-456 - JJ-21-463
JJ-21-456 37 x 32 mm
JJ-21-457 37 x 37 mm
JJ-21-458 37 x 43 mm
JJ-21-459 37 x 47 mm
JJ-21-460 37 x 52 mm
JJ-21-461 37 x 57 mm
JJ-21-462 37 x 62 mm
JJ-21-463 37 x 67 mm



JJ-21-464 - JJ-21-471
JJ-21-464 57 x 32 mm
JJ-21-465 57 x 37 mm
JJ-21-466 57 x 43 mm
JJ-21-467 57 x 47 mm
JJ-21-468 57 x 52 mm
JJ-21-469 57 x 57 mm
JJ-21-470 57 x 62 mm
JJ-21-471 57 x 67 mm

RETRACTORS FOR CERVICAL VERTEBRAL COLUMN



**CASPAR
JJ-21-472**
Distractor only for use in surgical procedures from the left approach the right approach for the upper cervical spine Distractor as above but with elongated toothed bar for multilevel (more than 2) distraction

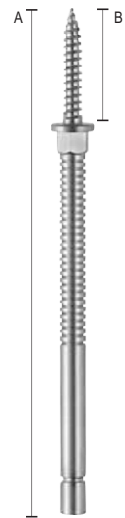

**DISTRACTION PIN A/B
JJ-21-473 - JJ-21-476**
JJ-21-473 66/12 mm
JJ-21-474 68/14 mm
JJ-21-475 70/16 mm
JJ-21-476 72/18 mm



**TWIST DRILL
JJ-21-477**



**DRILL GUIDE
JJ-21-478**



**SCREW DRIVER
JJ-21-479**



CASPAR
JJ-21-480

Distractor only for use in surgical procedures from the left approach the right approach for the upper cervical spine Distractor as above but with elongated toothed bar for multilevel (more than 2) distraction

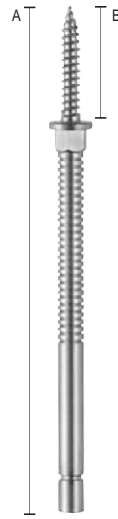

DISTRACTION PIN A/B
JJ-21-481 - JJ-21-484
JJ-21-481 66/12 mm
JJ-21-482 68/14 mm
JJ-21-483 70/16 mm
JJ-21-484 72/18 mm



TWIST DRILL
JJ-21-485



DRILL GUIDE
JJ-21-486



SCREW DRIVER
JJ-21-487

RETRACTORS FOR CERVICAL VERTEBRAL COLUMN



CLOWARD-TYPE
JJ-21-488
Vertebra Spreaders
130 mm
18 mm spread



JJ-21-489
one pointed tip
70 mm
arm, 80 mm spread



three pointed tips
JJ-21-490
850 mm arm,
70 mm spread
JJ-21-491
100 mm
arm, 70 mm spread



INGE
Lamina Spreaders
JJ-21-492 - JJ-21-493
JJ-21-492 165 mm
JJ-21-493 270 mm

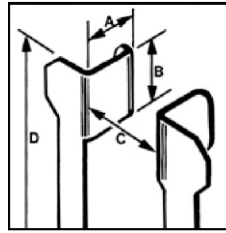

SCOVILLE-HAVERFIELD

	A	B	C	D
JJ-21-494	50 mm	35 mm	140 mm	140 mm
	50 mm			
with 1 each blade 29-3165.50 and 29-3162.51				
Frame only, hinged:				
JJ-21-495			140 mm	140 mm



Toothed:

JJ-21-502 - JJ-21-507	
JJ-21-502	63 mm x 26 mm
JJ-21-503	66 mm x 30 mm
JJ-21-504	89 mm x 26 mm
JJ-21-505	51 mm x 51 mm
JJ-21-506	63 mm x 51 mm
JJ-21-507	76 mm x 51 mm



3-prongs:

JJ-21-496 44 mm x 38 mm

4-prongs:

JJ-21-497 - JJ-21-501	
JJ-21-497	41 mm x 38 mm
JJ-21-498	66 mm x 48 mm
JJ-21-499	48 mm x 51 mm
JJ-21-500	63 mm x 63 mm
JJ-21-501	82 mm x 58 mm



Hook-shaped, blunt:

JJ-21-508 - JJ-21-509	
JJ-21-508	50 mm
JJ-21-509	75 mm

RETRACTORS FOR CERVICAL VERTEBRAL COLUMN



Williams
JJ-21-510
for microsurgical treatment
of herniated discs
170 mm
w = 10 mm
JJ-21-511 10 x 50 mm
JJ-21-512 10 x 60 mm
JJ-21-513 10 x 70 mm

w = 20 mm
JJ-21-514 20 x 50 mm
JJ-21-515 20 x 60 mm
JJ-21-516 20 x 70 mm



Williams
JJ-21-517
for microsurgical treatment
of herniated discs
170 mm
w = 10 mm
JJ-21-518 10 x 50 mm
JJ-21-519 10 x 60 mm
JJ-21-520 10 x 70 mm

w = 20 mm
JJ-21-521 20 x 50 mm
JJ-21-522 20 x 60 mm
JJ-21-523 20 x 70 mm



CLOWARD-TYPE
JJ-21-524
with slide lock Cervical Retractor Set with
slide-lock complete with 14 blades, 25 cm
JJ-21-525 – JJ-21-526
JJ-21-527 Retractor Body only (without blades), 25 cm

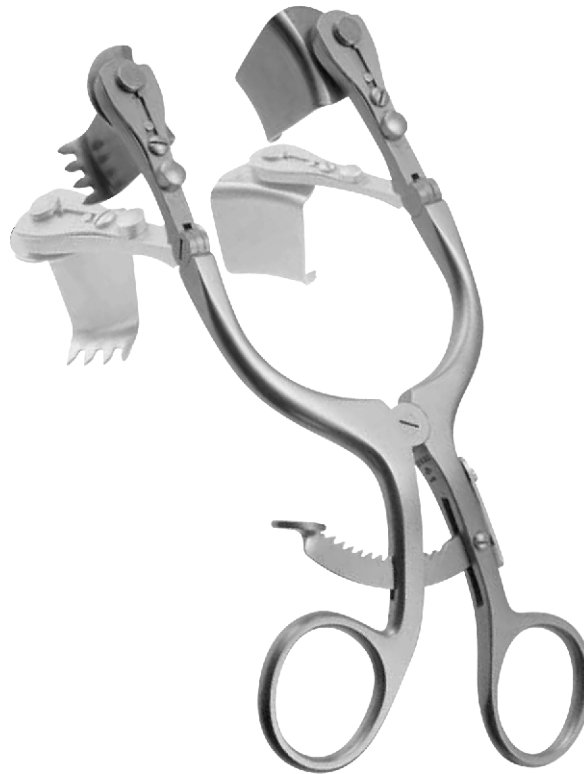

JJ-21-528
Cervical Retractor Set with
slide-lock complete with 14 blades, 16 cm
JJ-21-529 – JJ-21-530
JJ-21-531 Retractor Body only (without blades),
160 mm



JJ-21-532 - JJ-21-538
JJ-21-532 25 mm
JJ-21-533 30 mm
JJ-21-534 35 mm
JJ-21-535 40 mm
JJ-21-536 45 mm
JJ-21-537 50 mm
JJ-21-538 55 mm
blunt



JJ-21-539 - JJ-21-545
JJ-21-539 25 mm
JJ-21-540 30 mm
JJ-21-541 35 mm
JJ-21-542 40 mm
JJ-21-543 45 mm
JJ-21-544 50 mm
JJ-21-545 55 mm
blunt

Galea Hooks



YASARGIL
JJ-21-546
31 cm

YASARGIL
JJ-21-547
41 cm

Dura Protecting Forceps

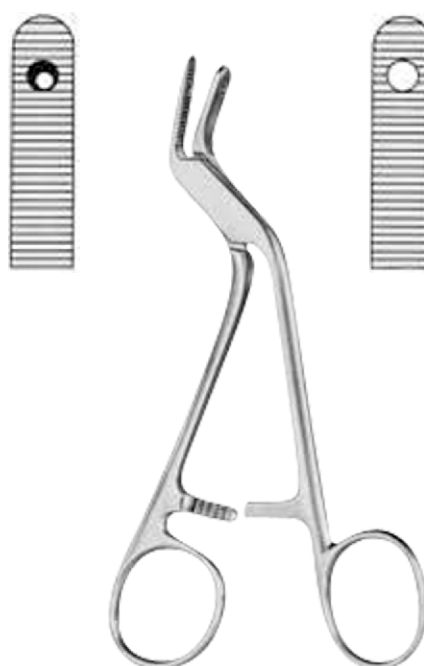

ADSON
JJ-21-548
15 cm



JJ-21-549
Silver Wires Mckenzie

Elio Carrier



MCKENZIE
JJ-21-550
148x40x60 mm
One Clip Holding



MCKENZIE
JJ-21-551
190x48x13 mm
Two Clips Holding

Silver Clips



JJ-21-552

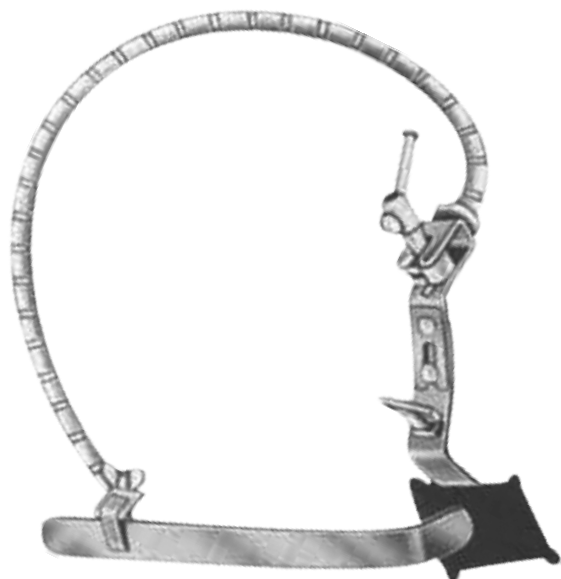

JJ-21-553
Complete Brain Ttractor
Set With 1 Arm



JJ-21-554
Complete Brain Ttractor
Set With 2 Arm

JJ-21-555
Complete Set

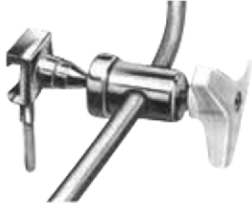

JJ-21-556
Ball and Socket Joint



JJ-21-557
Holding Rod, Head



JJ-21-558
Coupling Head



JJ-21-559
Fixation Base for skull
Mounting Holding 1
Flexible Arm



JJ-21-560
Fixation Base for skull
Mounting, Holding 2
Flexible Arms



JJ-21-561
Fixation Base for
Mounting to 16 mm Dia.
Holding 1 Flexible Arm

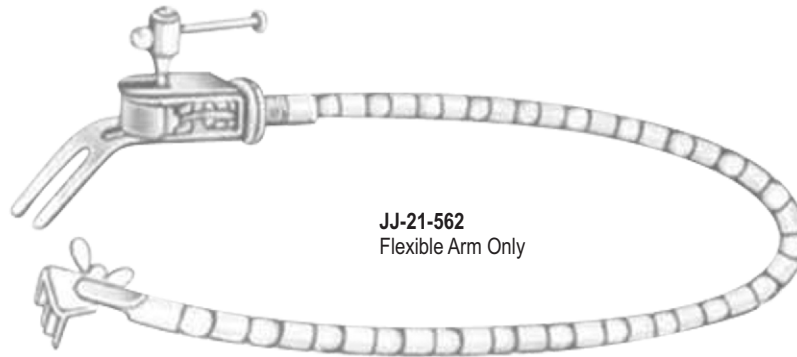

JJ-21-562
Flexible Arm Only



JJ-21-563
Support for Flat
Brain Spatula



JJ-21-564
Support for Brain Spatula
With Round Shaft



JJ-21-565
Holded for Ear Spatula

Page 500–534

- Abdominal Surgery
- Intestinal and Rectal Instruments

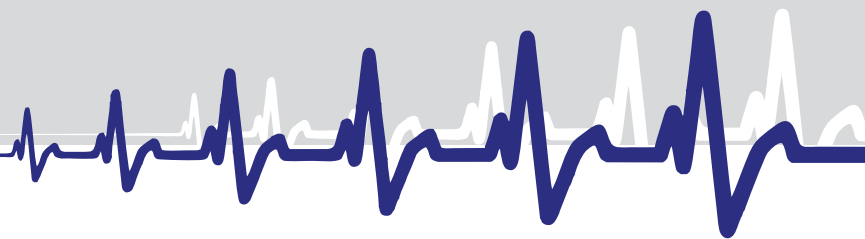

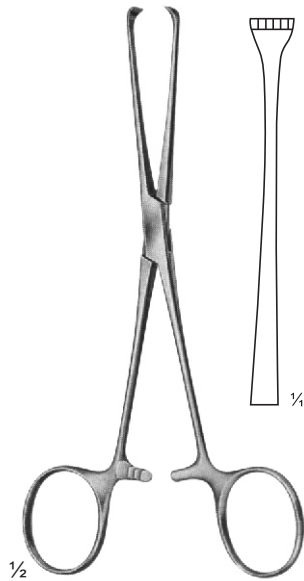

JJ-22-101
BOYS-ALLIS
5 X 6 teeth, sharp
155 mm,

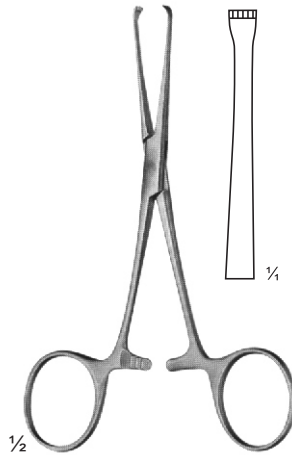

JJ-22-102
ALLIS
4 X 5 teeth
155 mm,

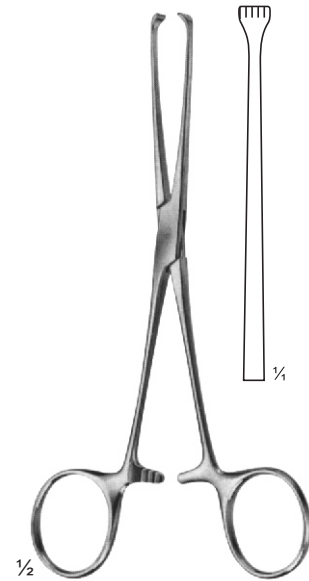

JJ-22-103
ALLIS
155 mm,
4 X 5 teeth

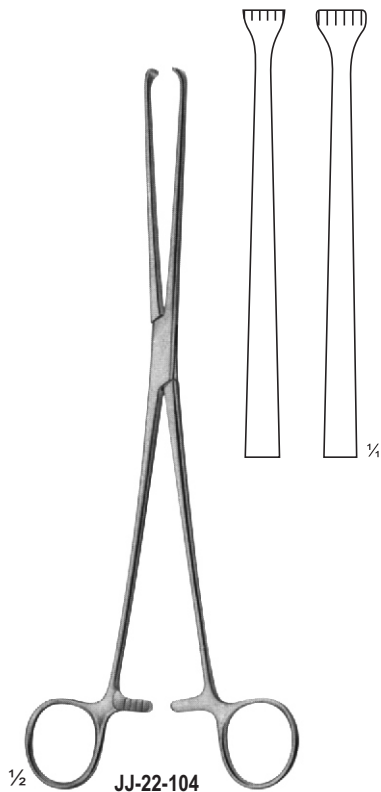

JJ-22-104
ALLIS
190 mm,
JJ-22-105
255 mm,
5 X 6 teeth

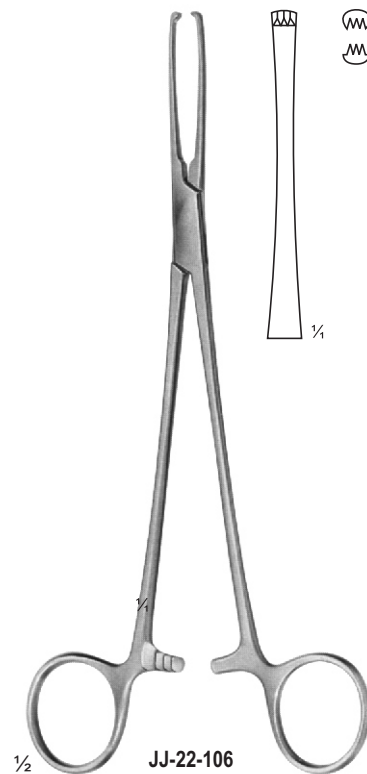

JJ-22-106
JUDD-ALLIS
3 X 4 teeth
195 mm,

INTESTINAL GRASPING FORCEPS

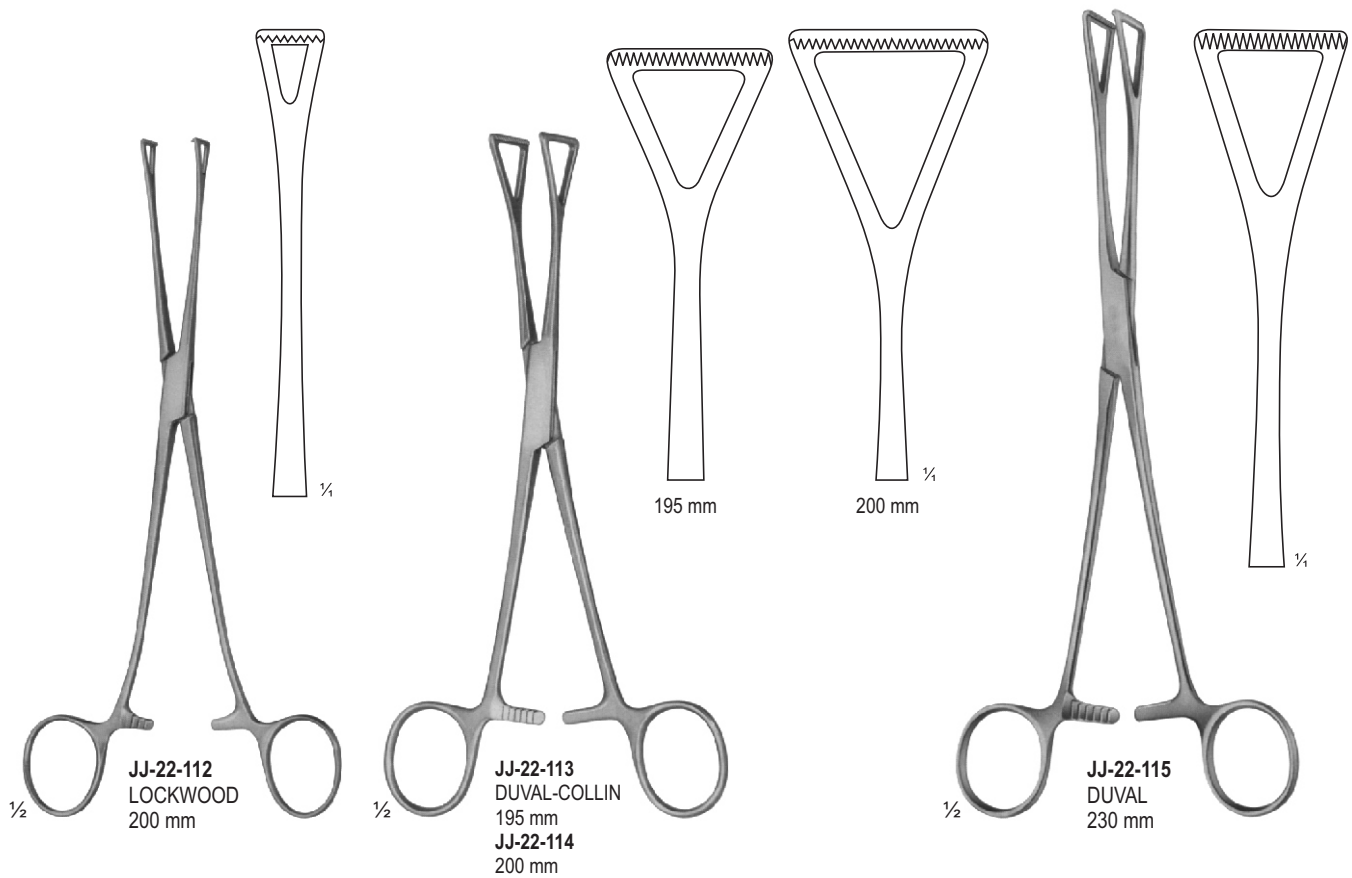
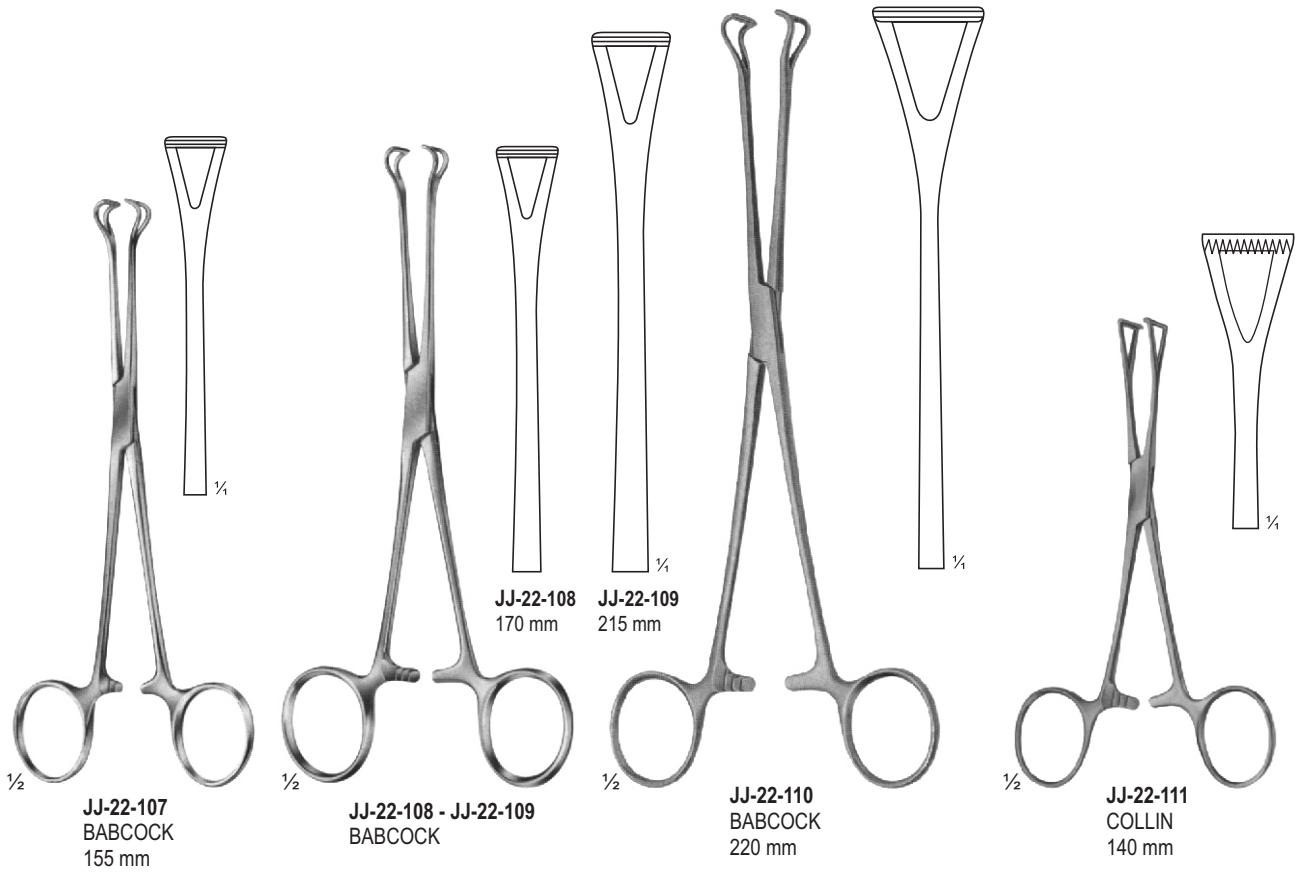

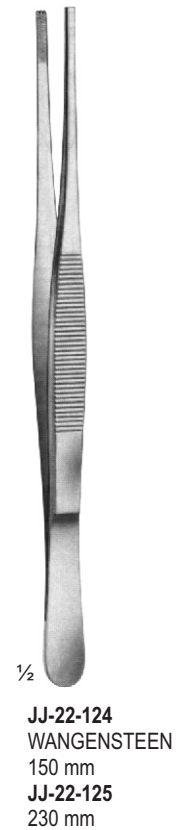
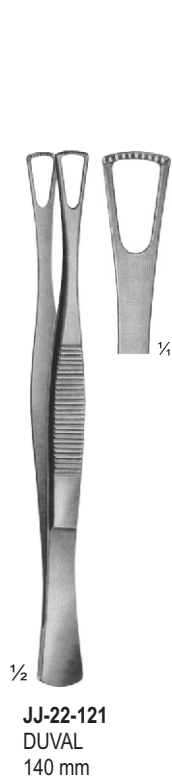
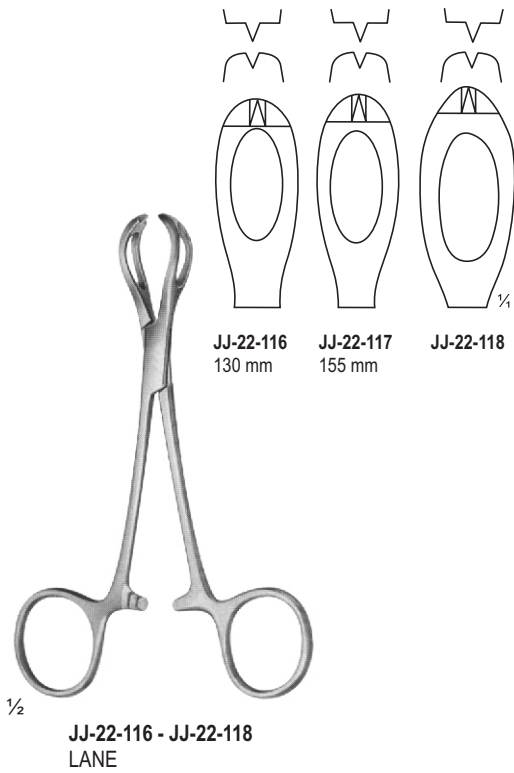

ORGAN - TISSUE GRASPING, DISSECTING AND INTESTINAL FORCEPS

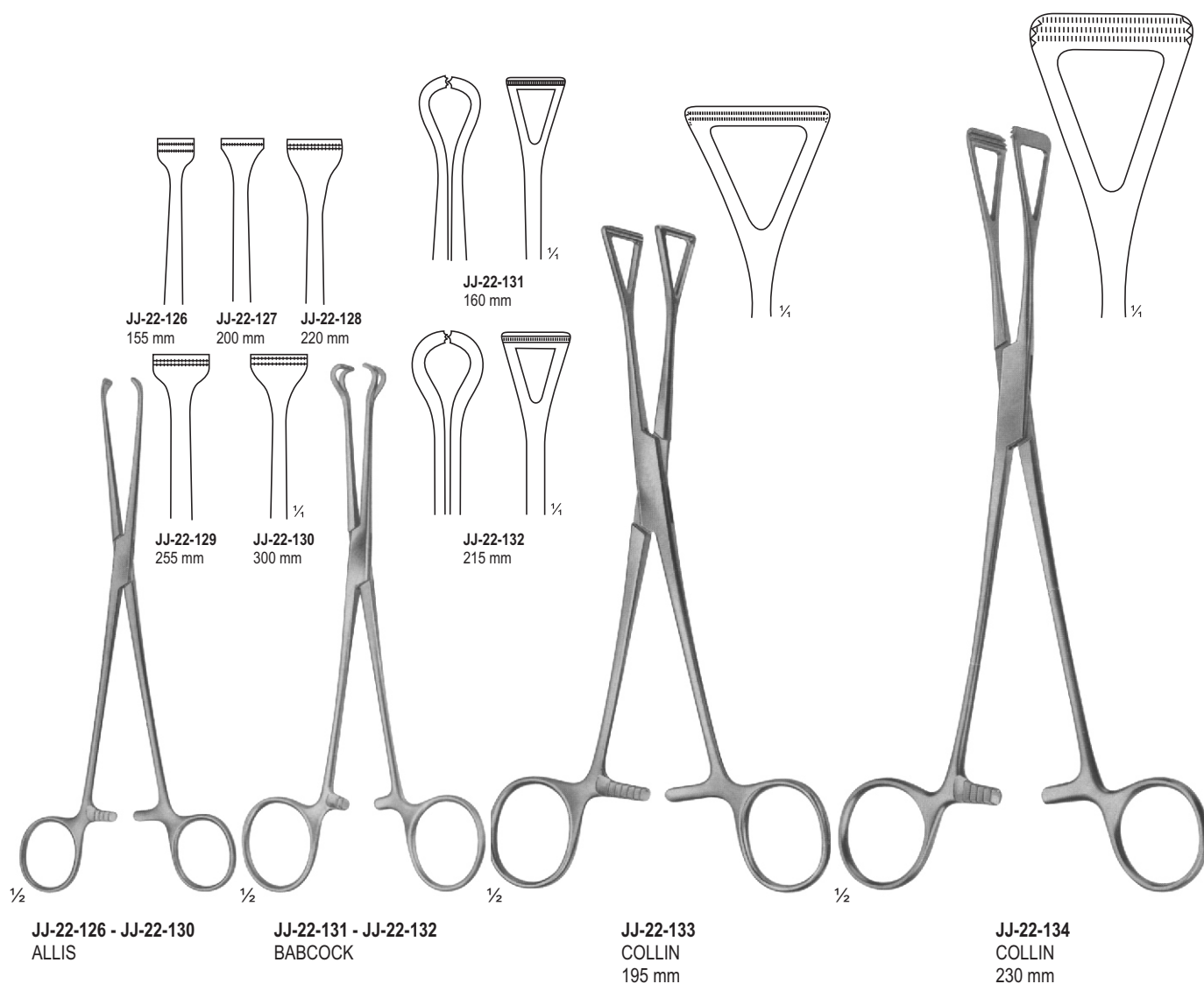



JJ-22-135 1,2 mm
JJ-22-136 1,5 mm
JJ-22-137 1,5 mm
JJ-22-138 1,5 mm

1/2

JJ-22-135 150 mm
JJ-22-136 200 mm
JJ-22-137 240 mm
JJ-22-138 300 mm



JJ-22-139 2 mm
JJ-22-140 2 mm
JJ-22-141 2 mm
JJ-22-142 2mm

1/2

DE BAKEY
JJ-22-139 150 mm
JJ-22-140 200 mm
JJ-22-141 240 mm
JJ-22-142 300 mm



JJ-22-143 2,8 mm
JJ-22-144 2,8 m
JJ-22-145 2,8 mm
JJ-22-146 2,8 mm

1/2

DE BAKEY
JJ-22-143 150 mm
JJ-22-144 200 mm
JJ-22-145 240 mm
JJ-22-146 300 mm



JJ-22-147 3,3 mm
JJ-22-148 3,3mm
JJ-22-149 3,3mm

1/2

DE BAKEY
JJ-22-147 200 mm
JJ-22-148 240 mm
JJ-22-149 300 mm

INTESTINAL CLAMPS FOR CHILDREN

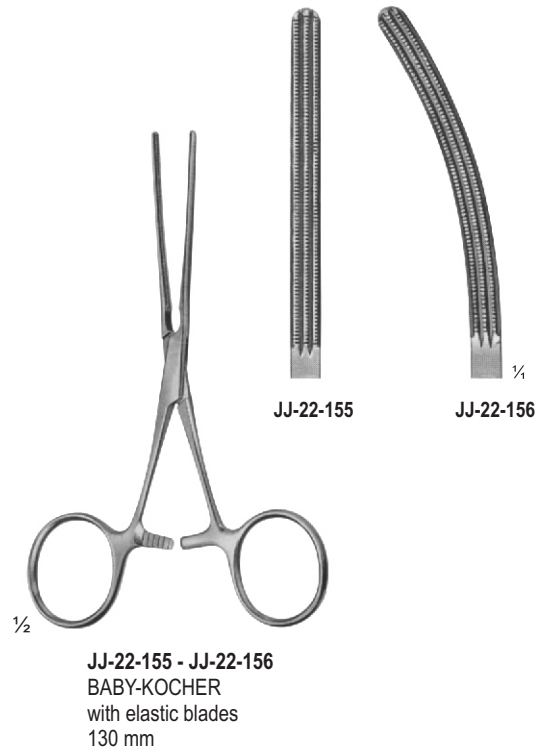
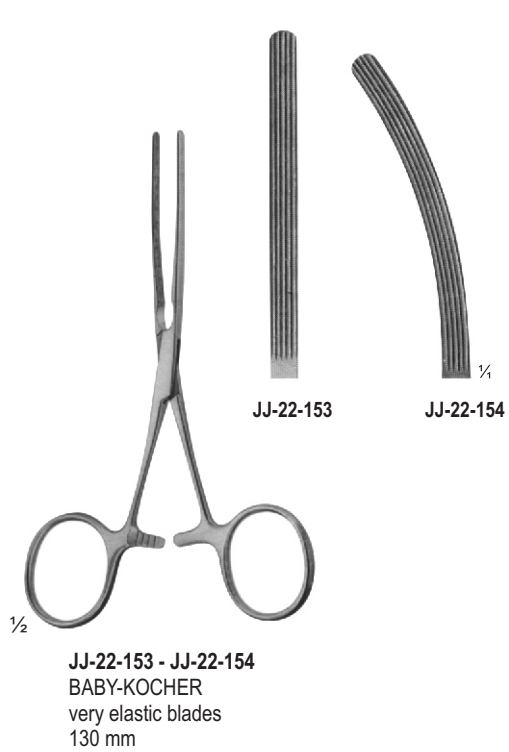
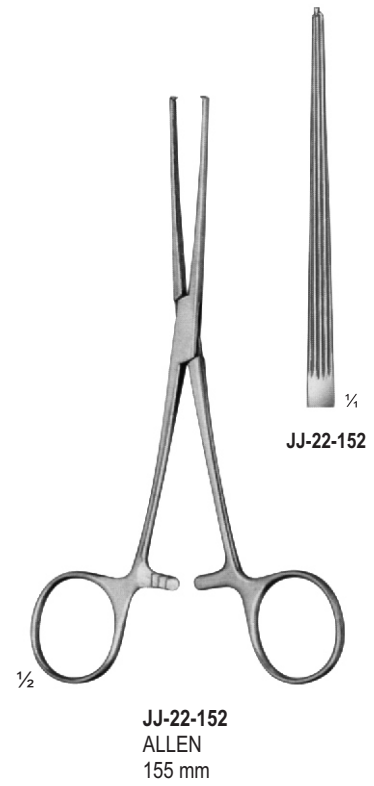
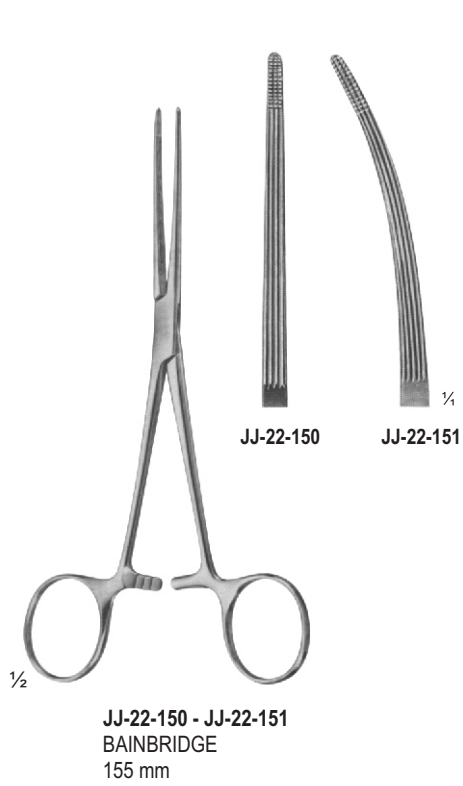

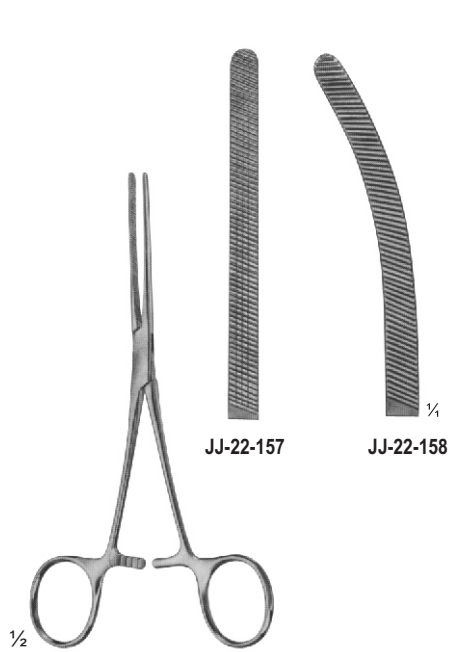

JJ-22-157 - JJ-22-158
DOYEN
elastic
165 mm

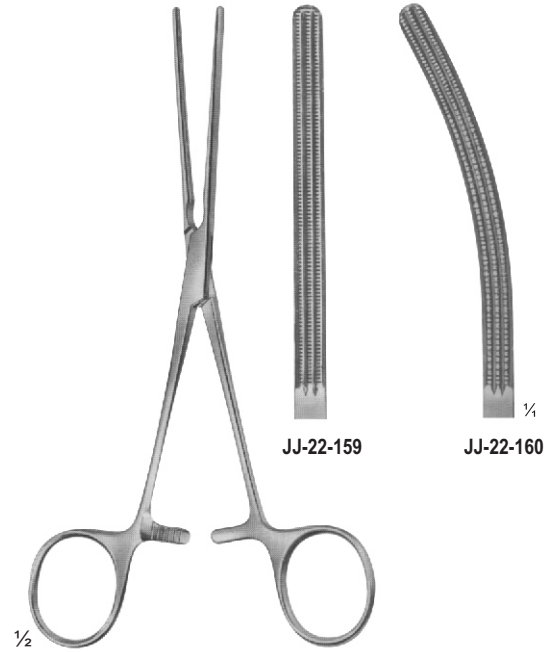

JJ-22-159 - JJ-22-160
DOYEN
with elastic blades
170 mm

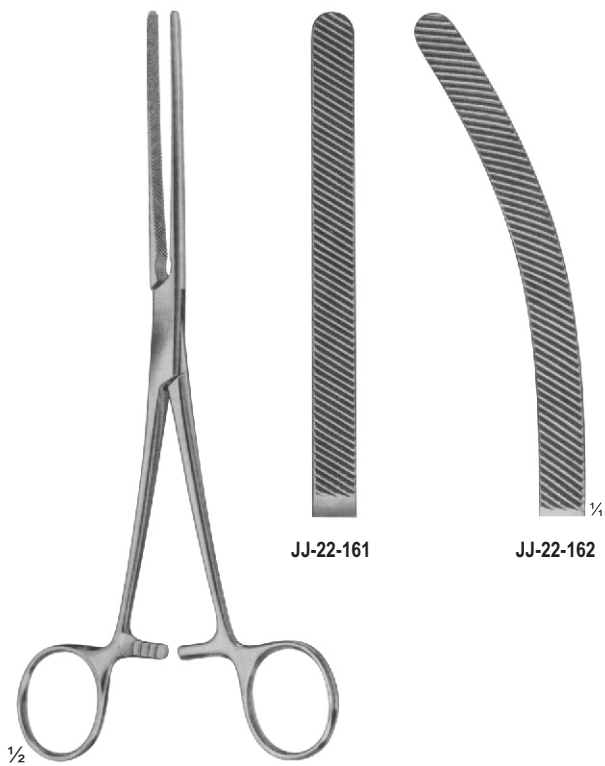

JJ-22-161 - JJ-22-162
HARTMANN
with elastic blades
200 mm

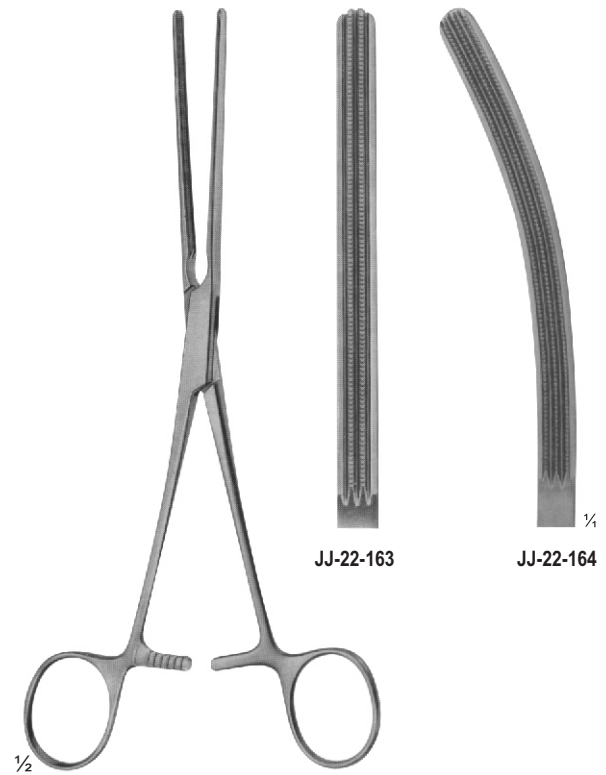

JJ-22-163 - JJ-22-164
HARTMANN
with elastic blades
200 mm

INTESTINAL CLAMPS, SOFT ELASTIC

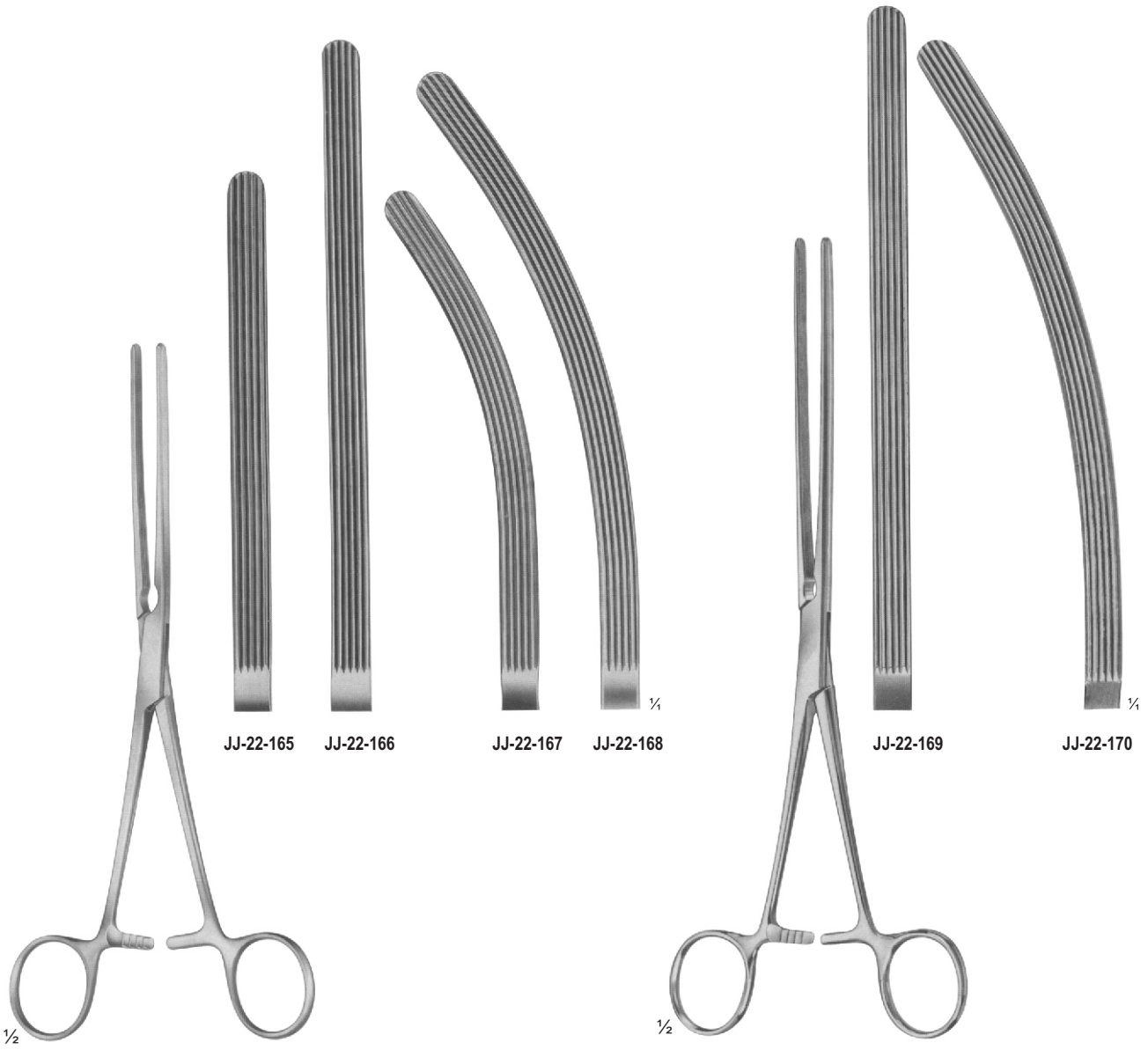

JJ-22-165 - JJ-22-168
KOCHER
 with elastic blades
JJ-22-167 210 mm
JJ-22-168 230 mm

JJ-22-169 - JJ-22-170
DOYEN
 with elastic blades
 210 mm



JJ-22-171

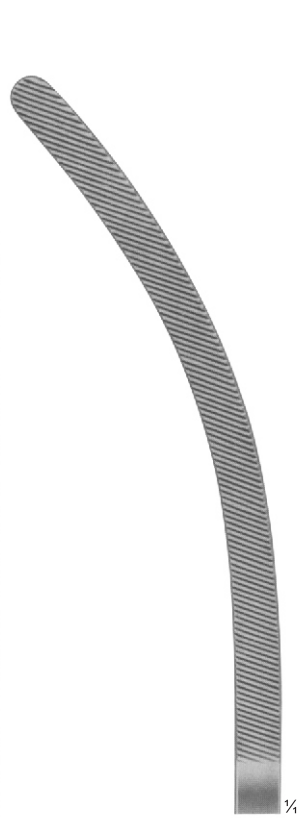

JJ-22-172

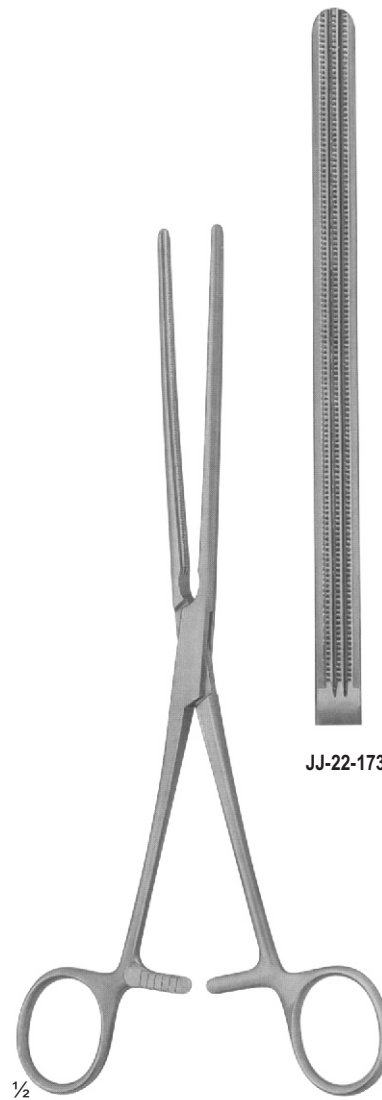

JJ-22-173

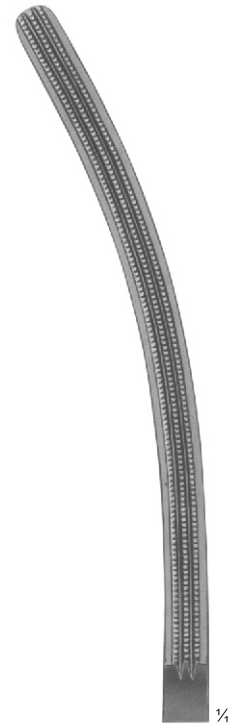

JJ-22-174

JJ-22-171 - JJ-22-172
DOYEN
with elastic blades
235 mm

JJ-22-173 - JJ-22-174
DOYEN
with elastic blades
230 mm

INTESTINAL CLAMPS, SOFT ELASTIC

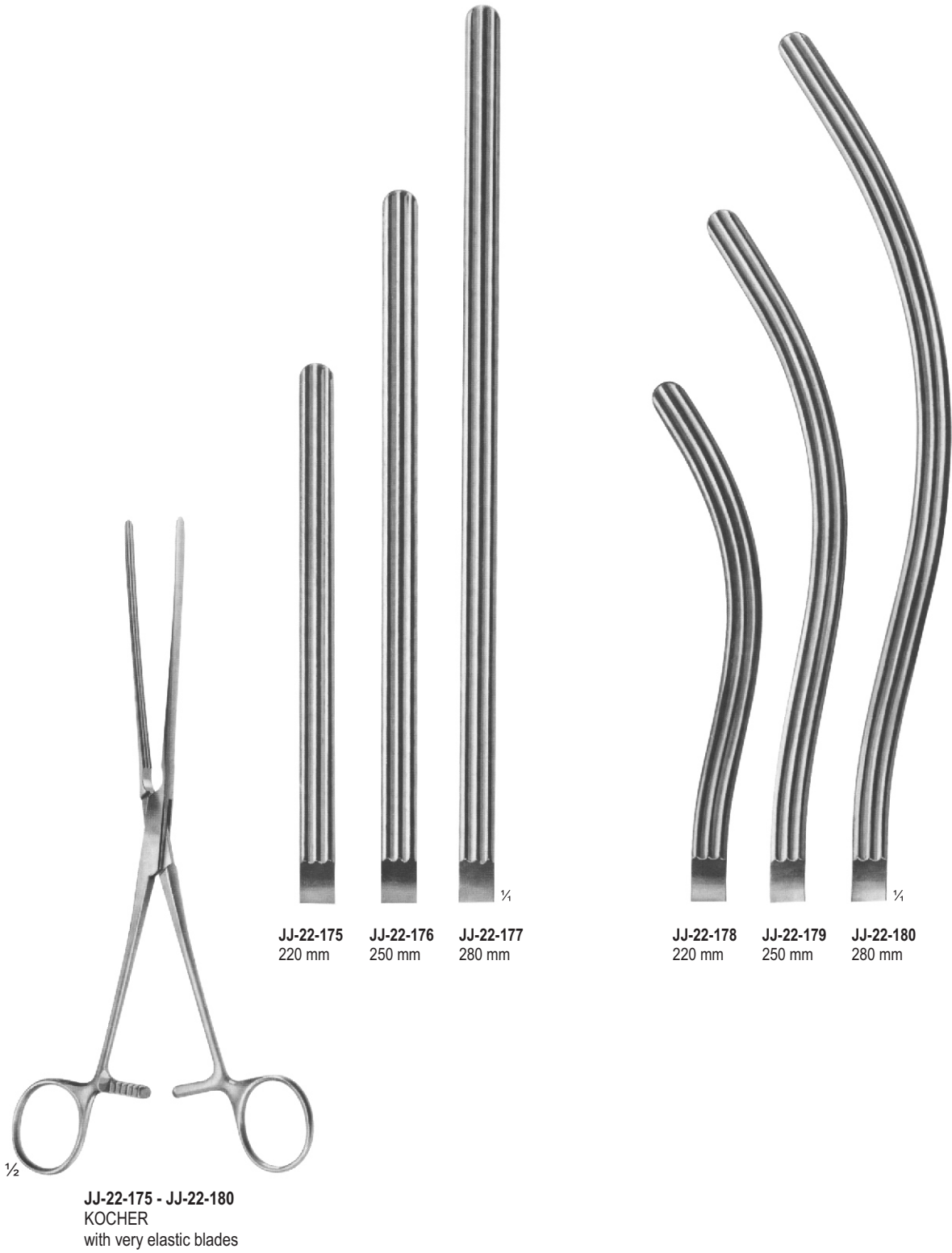

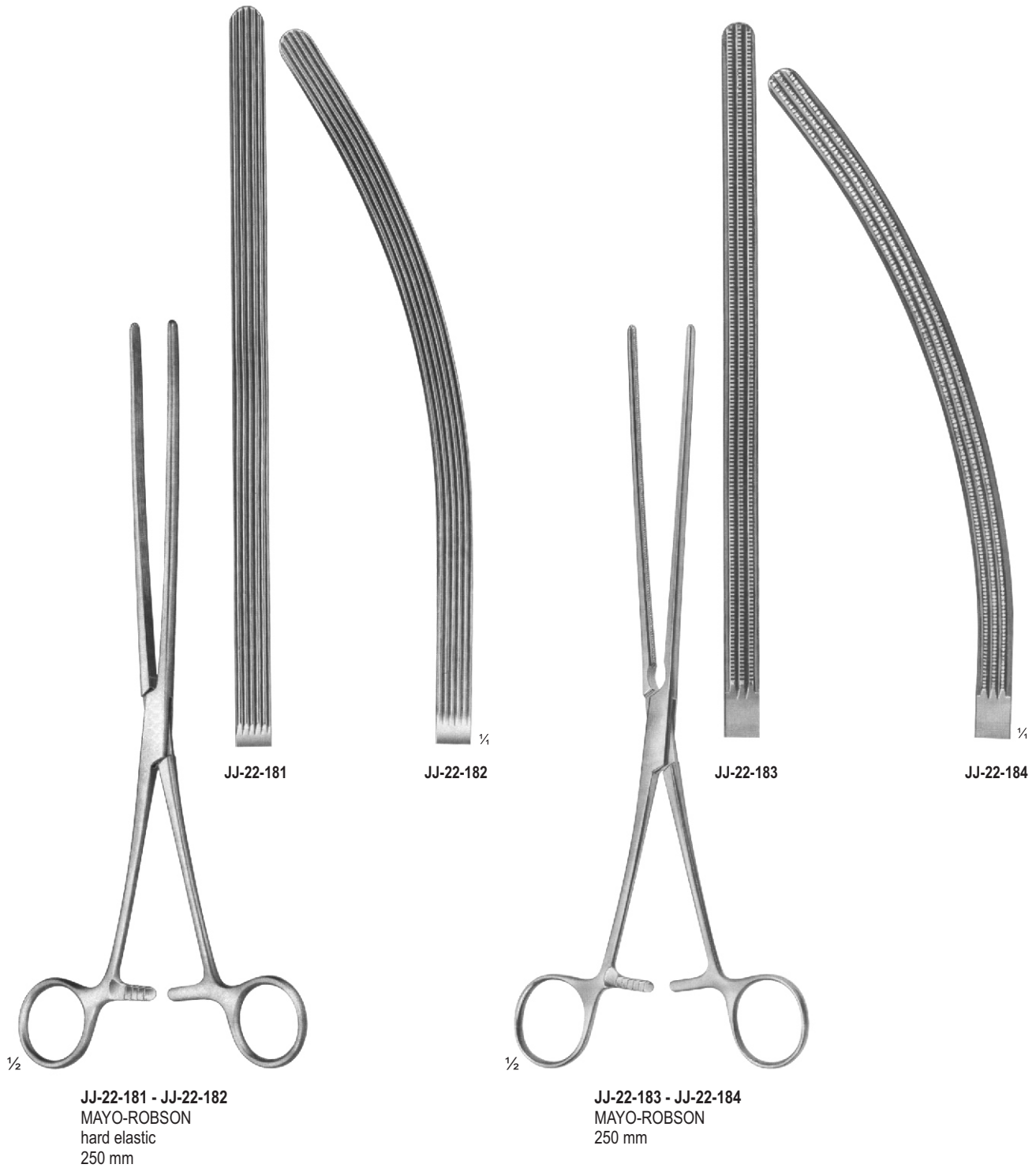

STOMACH CLAMPS



¼

JJ-22-185



¼

JJ-22-186

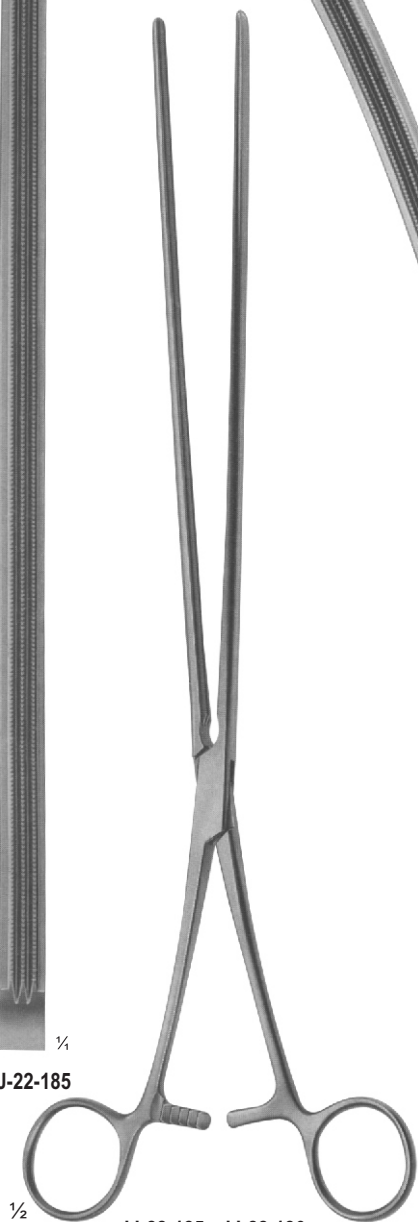

½

JJ-22-185 - JJ-22-186
SCUDDER
330 mm



½

JJ-22-187
KLEINSCHMIDT
Spur crushers and
Appendectomy clamps
130 mm

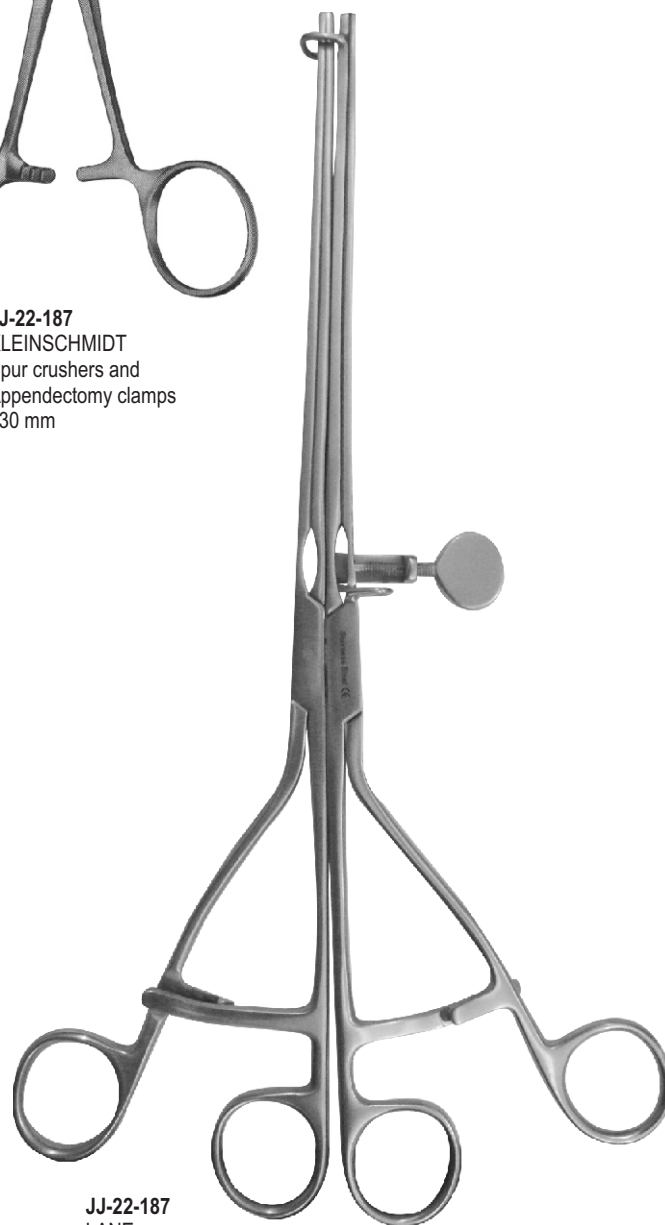

JJ-22-187
LANE
310 mm, 12"



JJ-22-188
PAYR
Intestinal clamp light
pattern, for children
180 mm

JJ-22-189
PAYR
200 mm

JJ-22-190
PAYR
275 mm

JJ-22-191
PAYR
Pylorus clamp
315 mm

INTESTINAL CLAMPS, SOFT ELASTIC



BRUNNER
JJ-22-192
230 mm



FEHLAND
JJ-22-193
240 mm

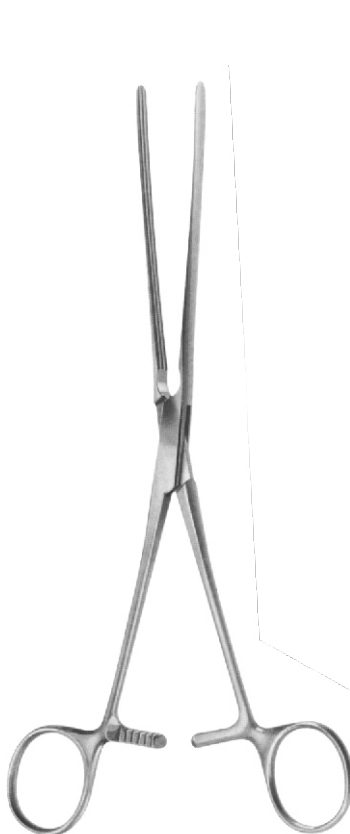

Straight

KOCHER
with very elastic blades
JJ-22-194 - JJ-22-196
JJ-22-194 22 cm
JJ-22-195 25 cm
JJ-22-196 28 cm

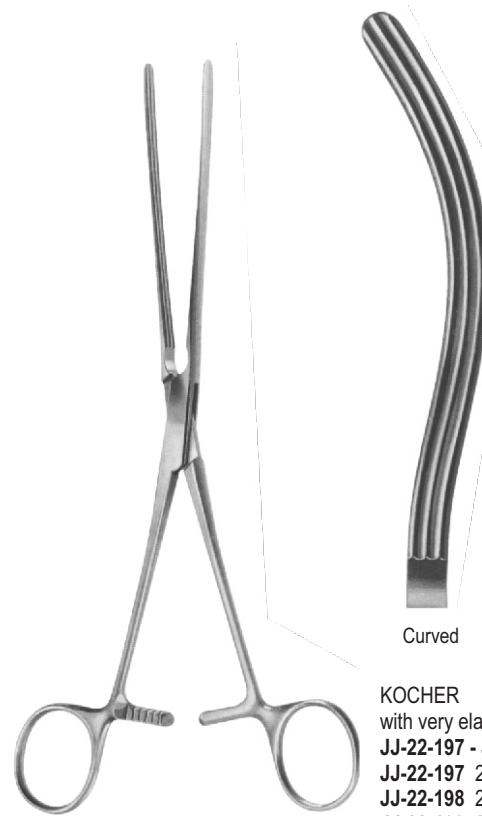

Curved

KOCHER
with very elastic blades
JJ-22-197 - JJ-22-199
JJ-22-197 22 cm
JJ-22-198 25 cm
JJ-22-199 28 cm

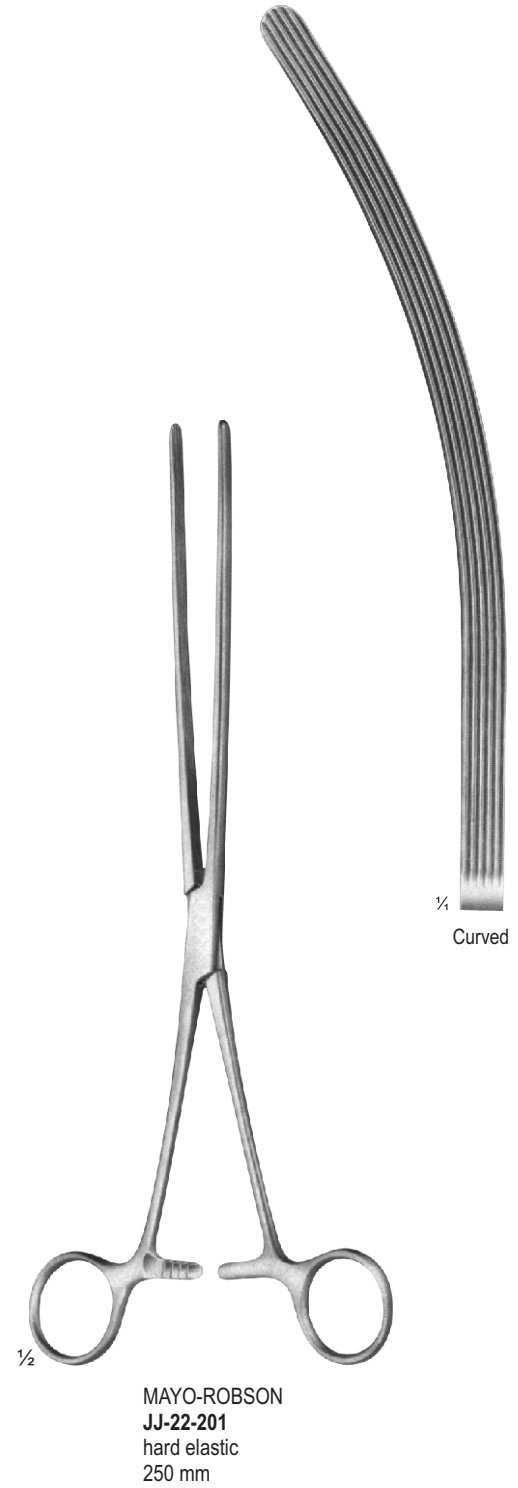
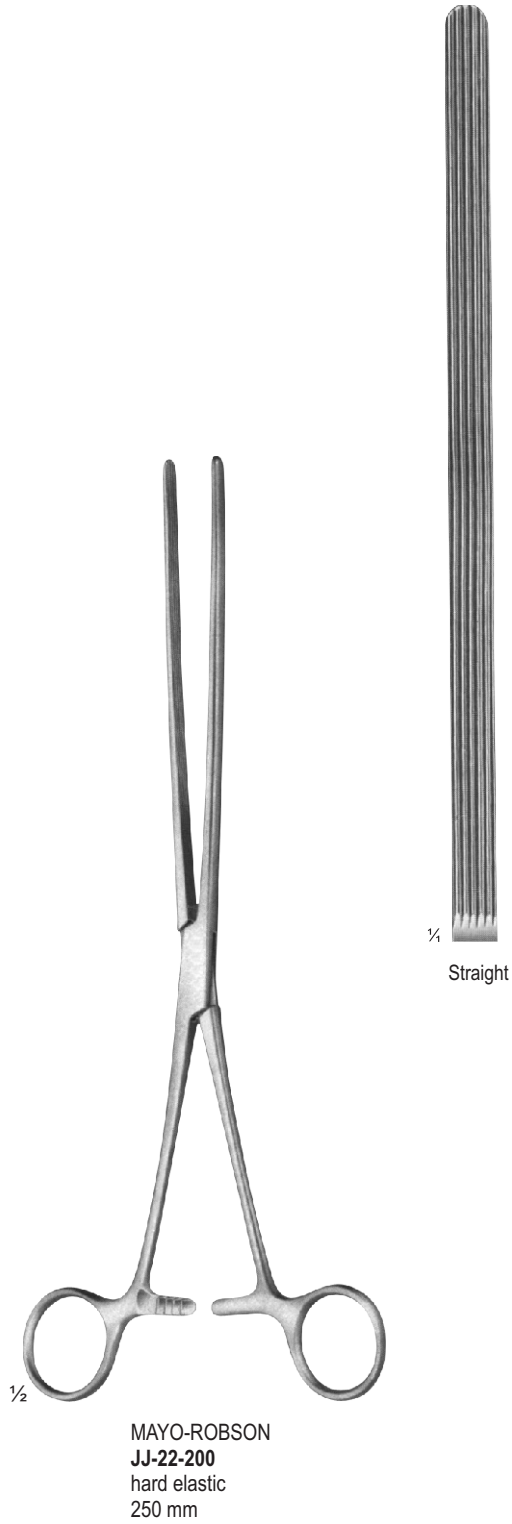

INTESTINAL CLAMPS

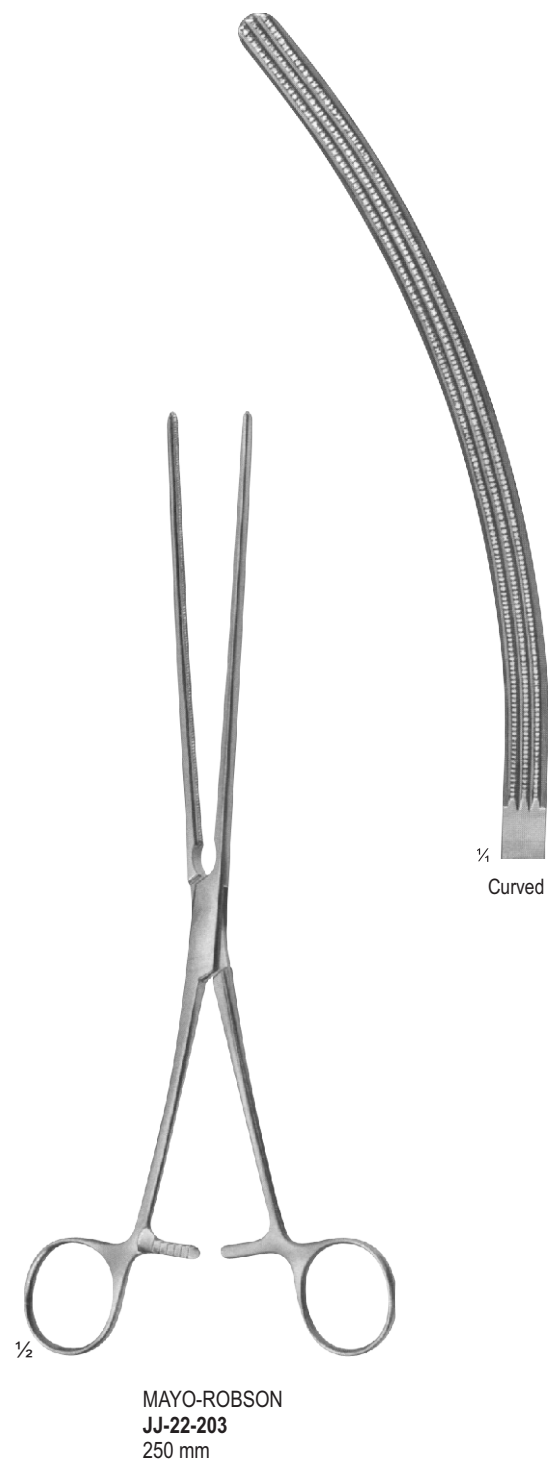
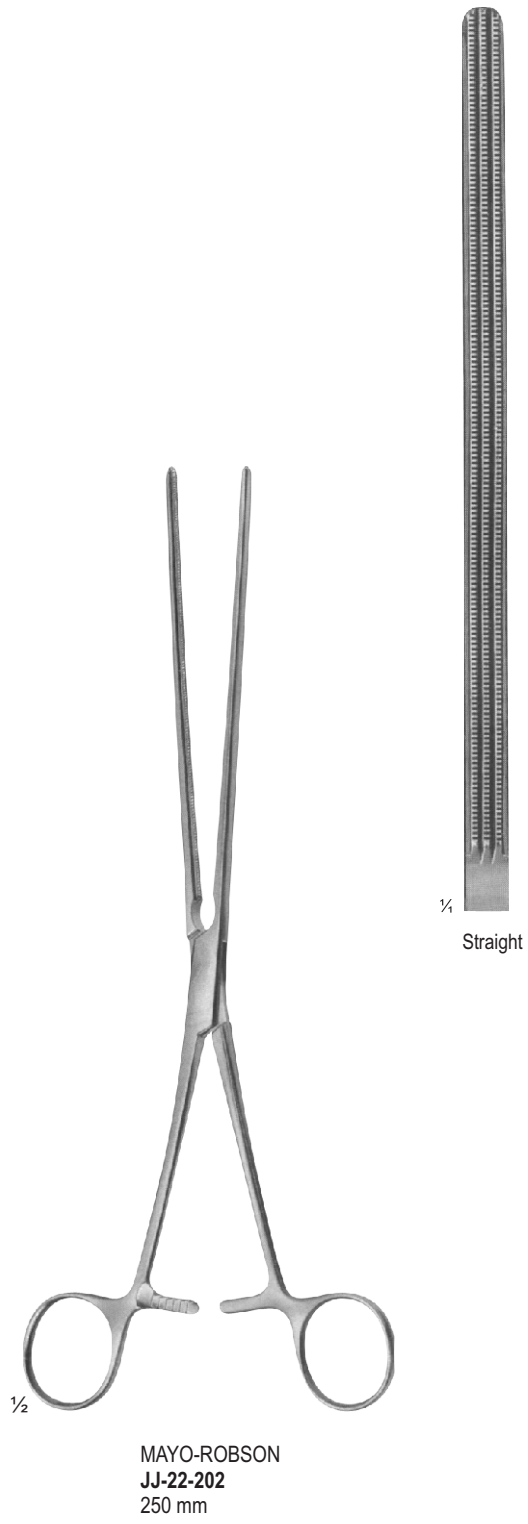

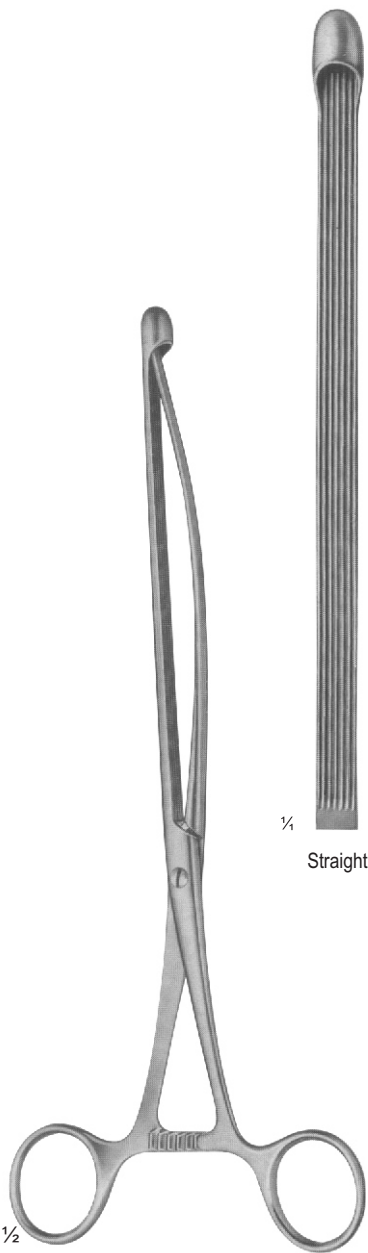

**NUSSBAUM
JJ-22-204**
with elastic blades
250 mm



**NUSSBAUM
JJ-22-205**
with elastic blades
250 mm

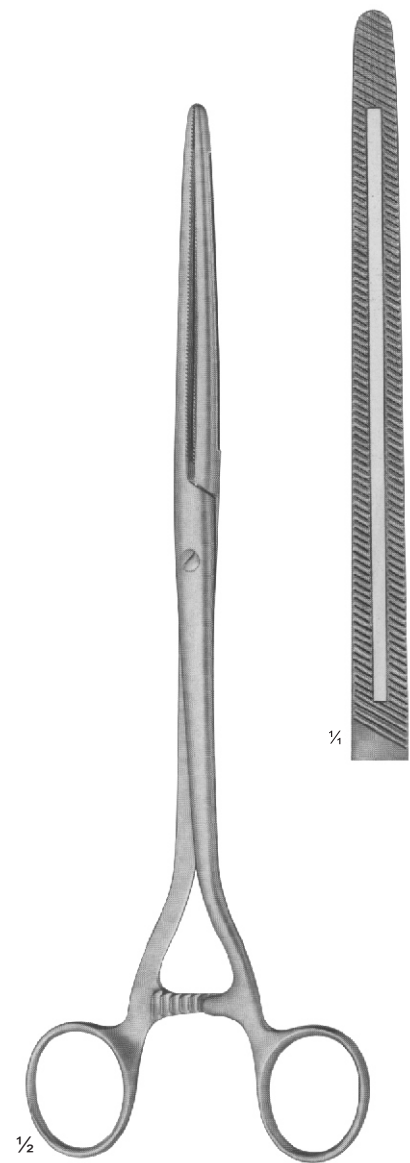

**MOYNIHAN
JJ-22-206**
280 mm

SIGMOID ANASTOMOSIS FORCEPS



PARKER-KERR
JJ-22-207
anastomosis forceps
for colon resection
180 mm

DICK
pressure clamps
JJ-22-208 - JJ-22-211
JJ-22-208 180 mm
JJ-22-209 255 mm
JJ-22-210 265 mm
JJ-22-211 275 mm

LLOYD-DAVIS
JJ-22-212
315 mm

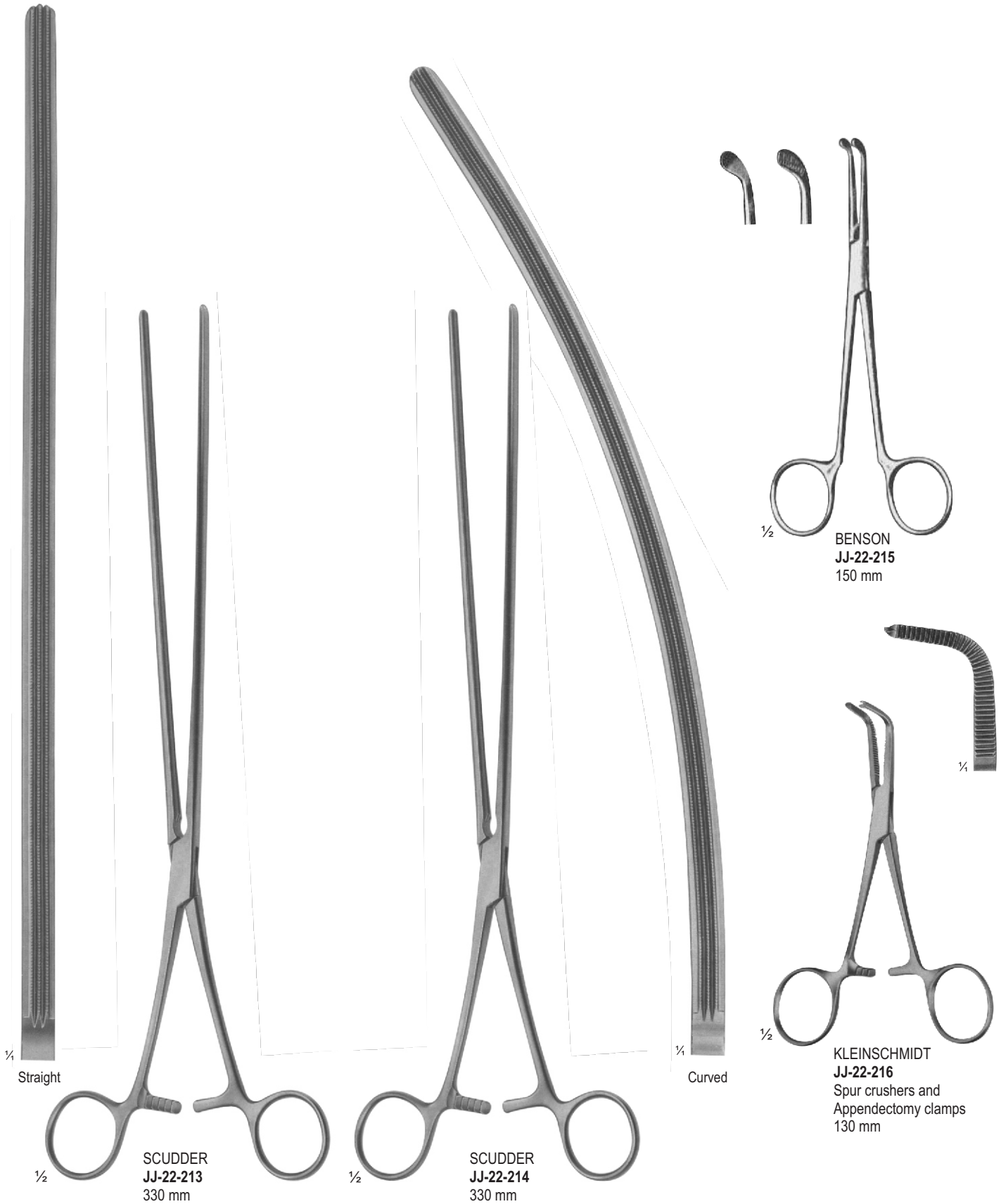

INTESTINAL CLAMPS

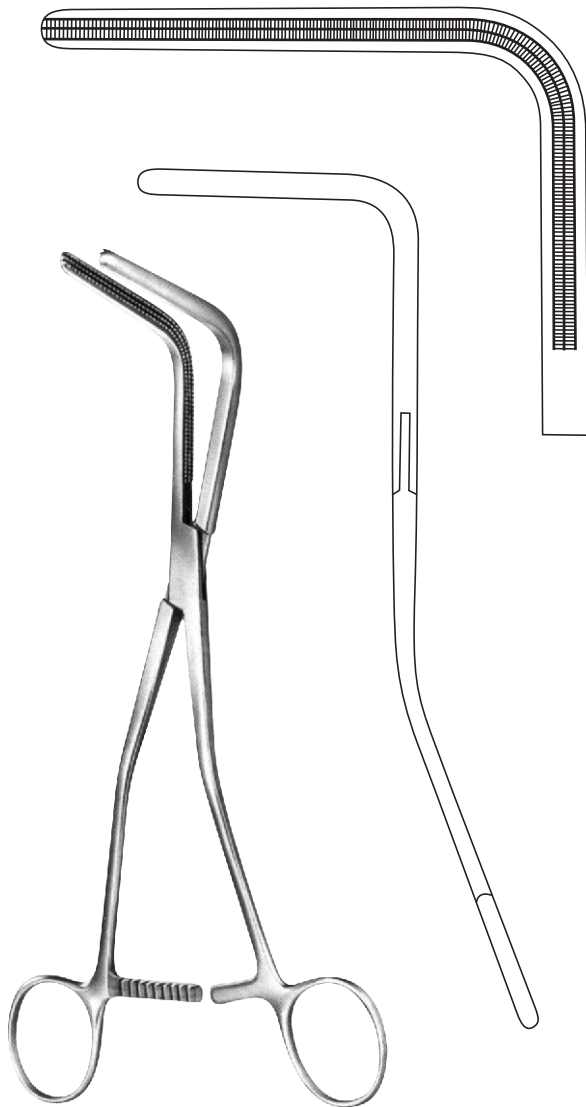

VEIDENHEIMER
JJ-22-217
250 mm



RESANO
JJ-22-218
280 mm

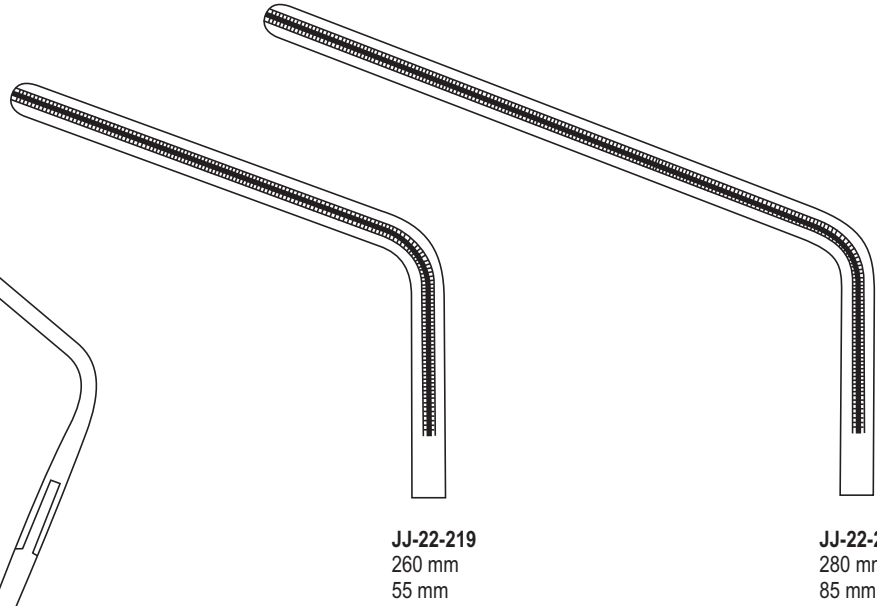
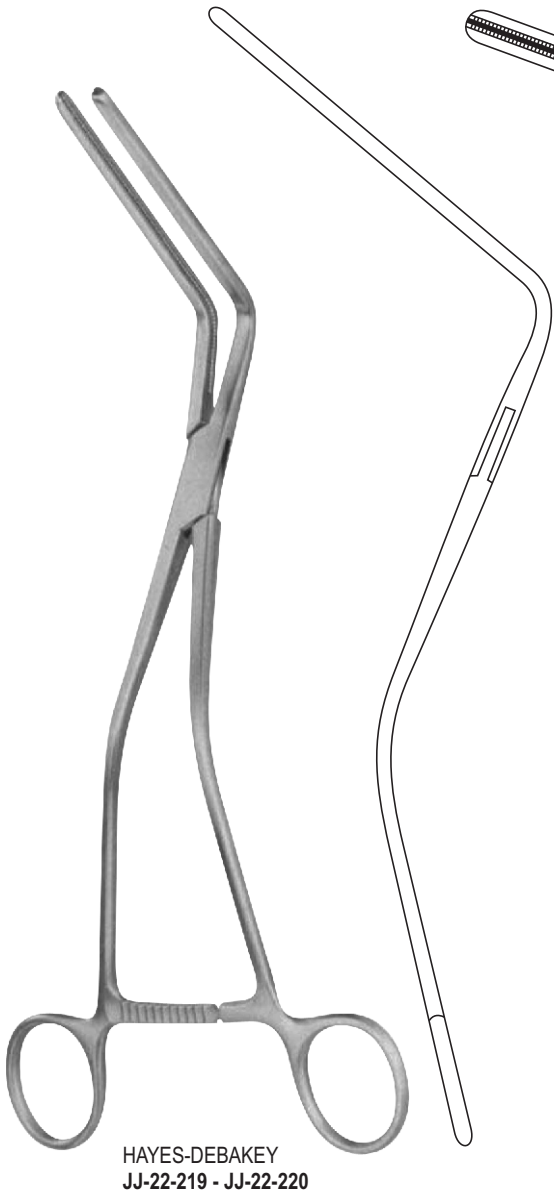

SIGMOID ANASTOMOSIS FORCEPS

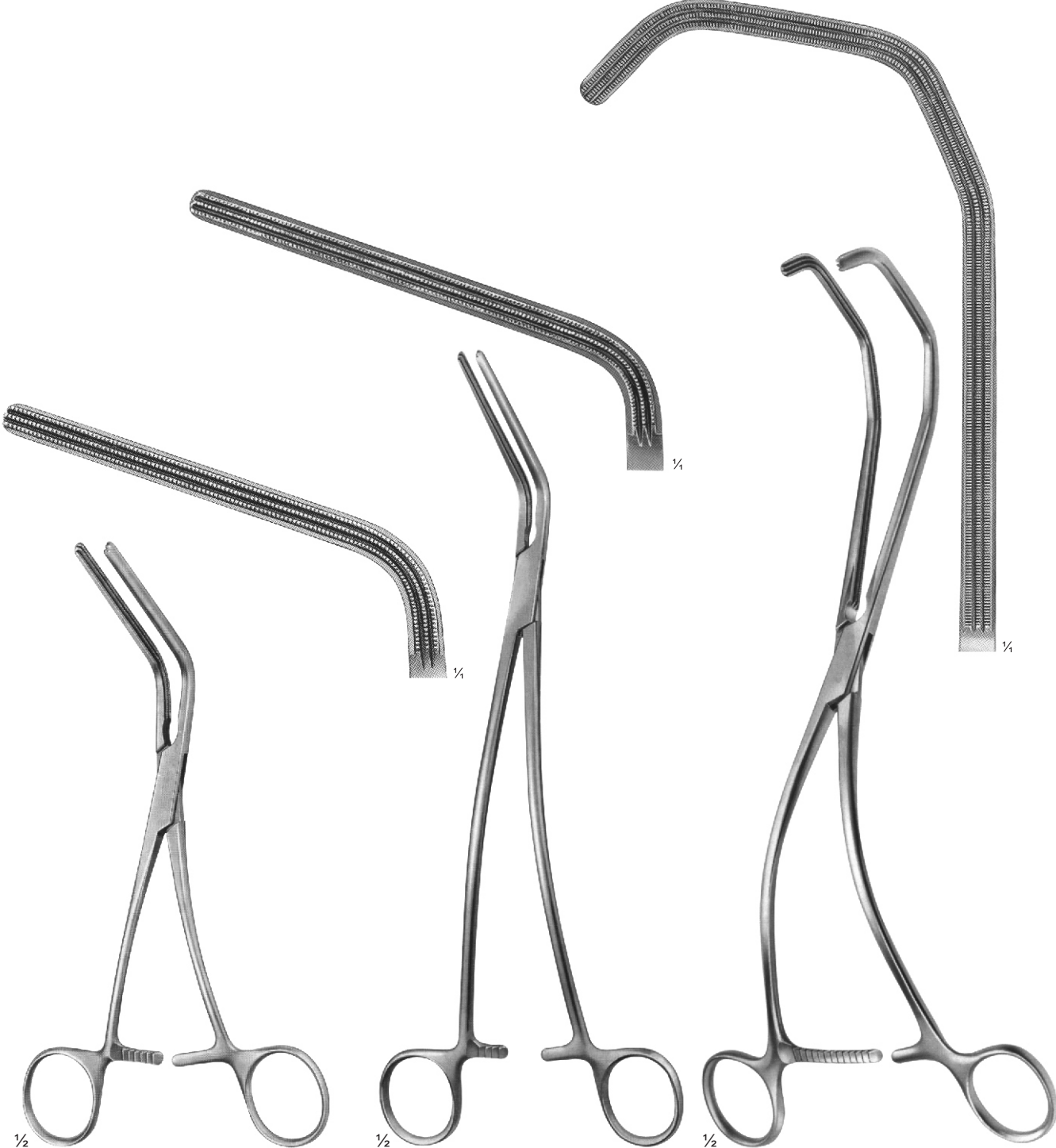

JJ-22-222
MORRIS
175 mm

JJ-22-223
DE BAKEY
(MORRIS modif.)
240 mm

JJ-22-224
KERSTING
270 mm

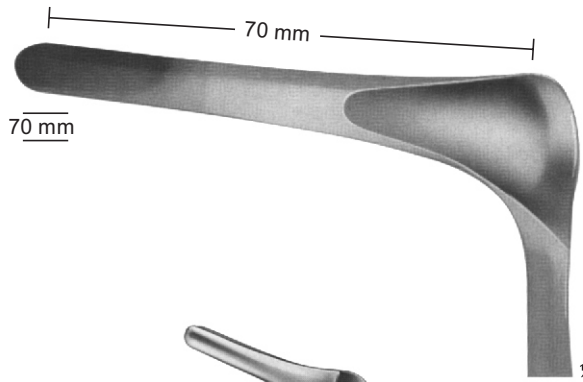

JJ-22-225
KILLIAN
for children
145 mm



JJ-22-226
SIMS
160 mm



JJ-22-227
SIMS
160 mm

INTESTINAL AND PYLORUS CLAMPS



CZERNY
JJ-22-228
220 mm



ROSCHKE
JJ-22-229
with fibre optic

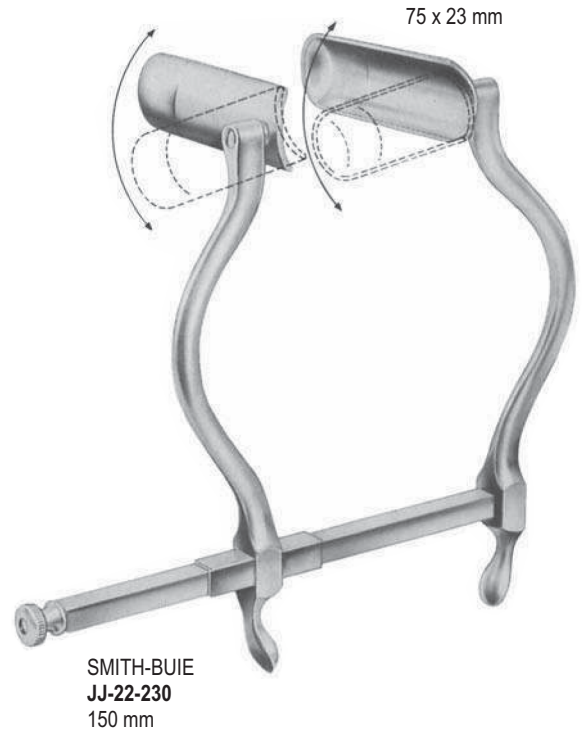

SMITH-BUIE
JJ-22-230
150 mm



BARR
JJ-22-231
170 mm

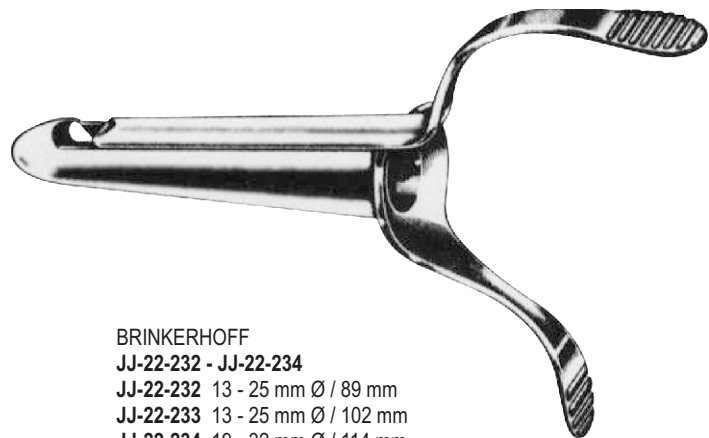

BRINKERHOFF
JJ-22-232 - JJ-22-234
JJ-22-232 13 - 25 mm Ø / 89 mm
JJ-22-233 13 - 25 mm Ø / 102 mm
JJ-22-234 19 - 32 mm Ø / 114 mm

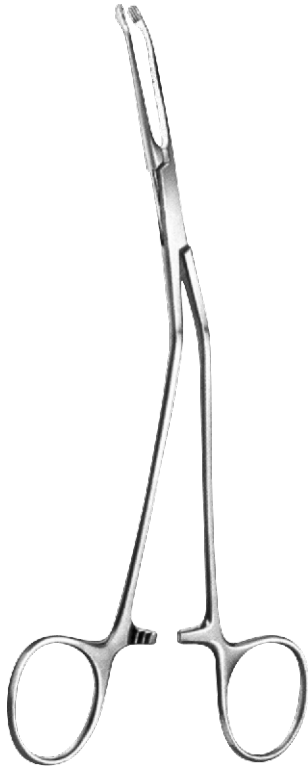

MCGIVNEY
JJ-22-235
190 mm

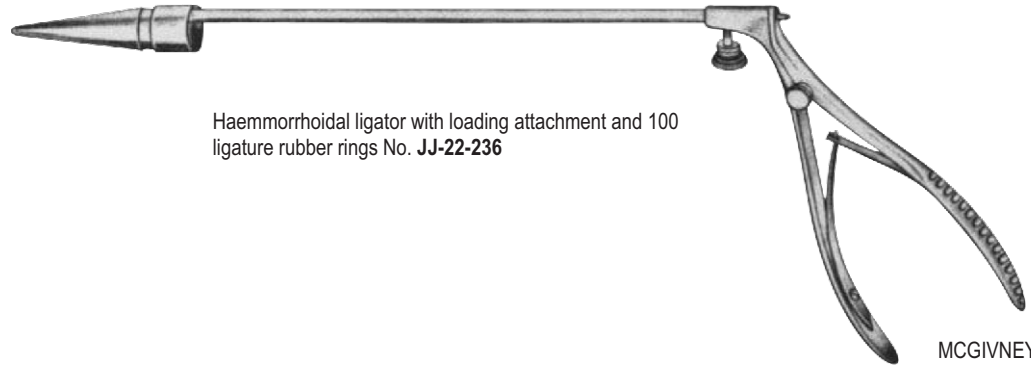

Haemorrhoidal ligator with loading attachment and 100 ligature rubber rings No. JJ-22-236

MCGIVNEY
JJ-22-236

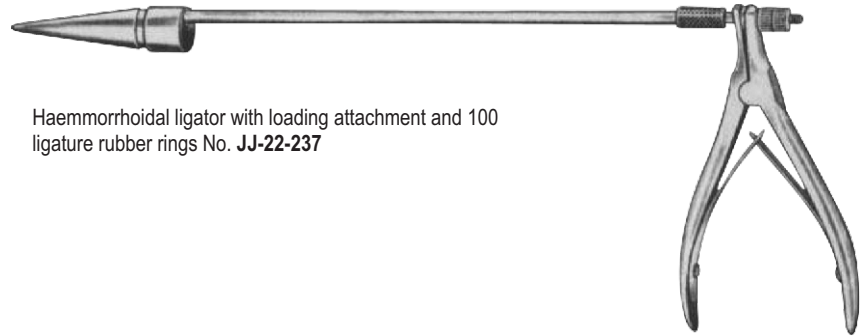

Haemorrhoidal ligator with loading attachment and 100 ligature rubber rings No. JJ-22-237

FORD-DIXON
JJ-22-237

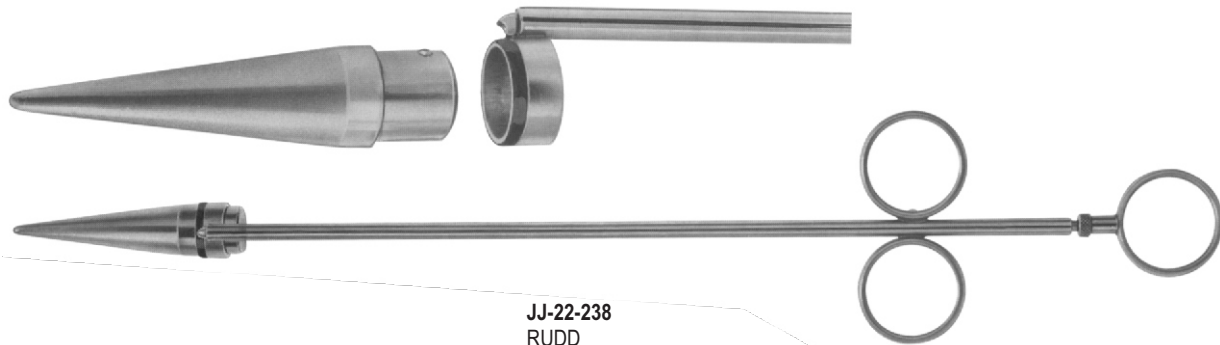

JJ-22-238
RUDD
Haemorrhoidal ligator
with loading
attachment and 100
ligature rubber rings
315 mm



RUDD
JJ-22-239
100 pieces

BIOPSY FORCEPS AND SWAB HOLDERS

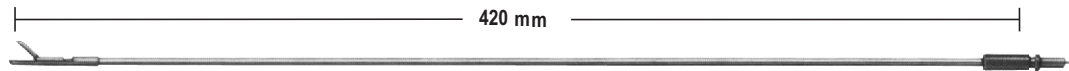

3.5 mm



3.5 mm



4 mm

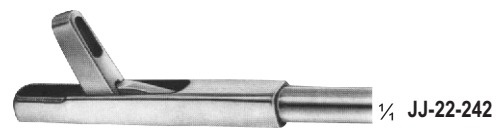
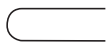

4 mm

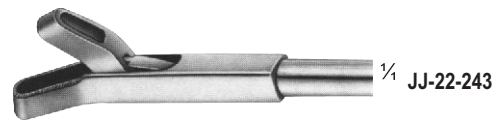

JJ-22-240 - JJ-22-243
Handle for 265 - 266 - 267 - 268

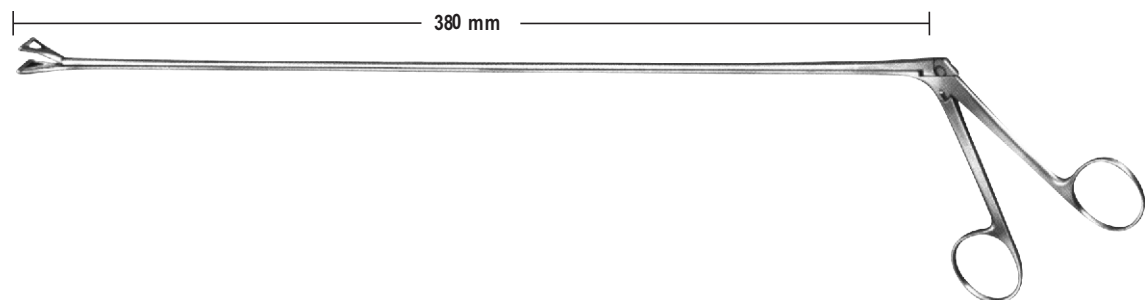

MAULBREITE
JAW WIDTH
JJ-22-244
380 mm
15 mm



BUIE
JJ-22-245
160 mm



PRATT
JJ-22-246 - JJ-22-248
215 mm

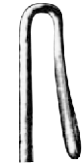

Fig. 1
JJ-22-246

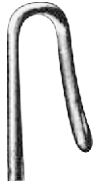

Fig. 2
JJ-22-247

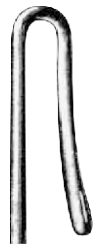
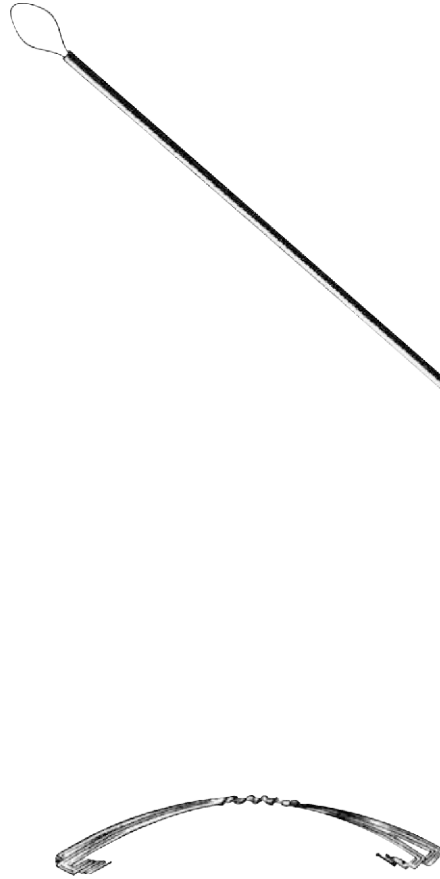

Fig. 3
JJ-22-248



JJ-22-249
12 pieces / 12 piezas



WESTON
JJ-22-250
300 mm

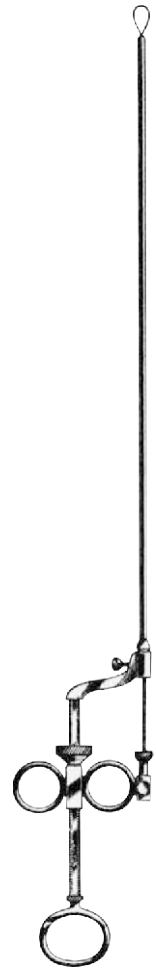

NORWOOD
JJ-22-251
300 mm



BUIE
JJ-22-252
300 mm

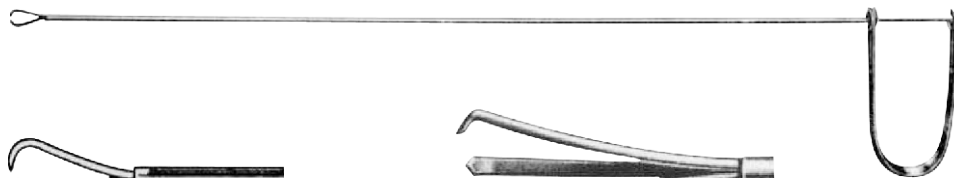

JJ-22-253
380 mm

JJ-22-254
380 mm



KATZENSTEIN
JJ-22-255
90 mm

RECTAL SPECULA



1/2 JJ-22-256 - JJ-22-259

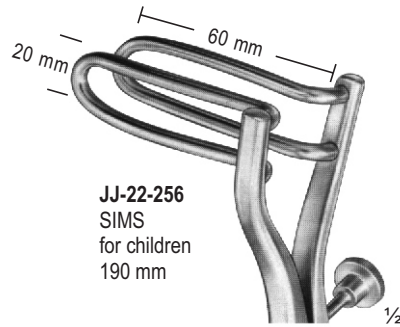

JJ-22-256
SIMS
for children
190 mm

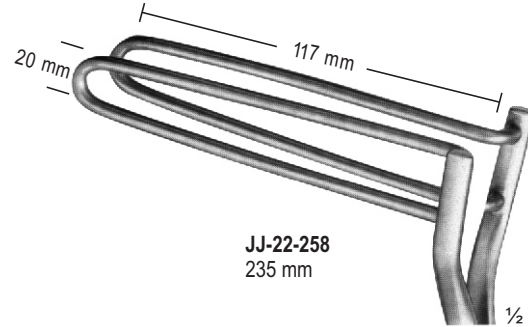

JJ-22-258
235 mm

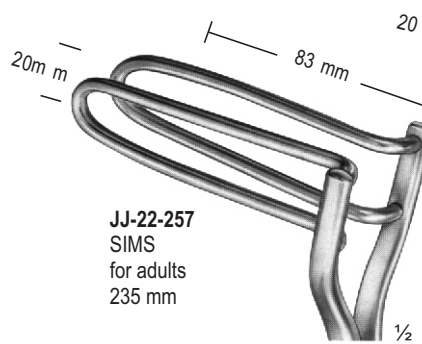

JJ-22-257
SIMS
for adults
235 mm

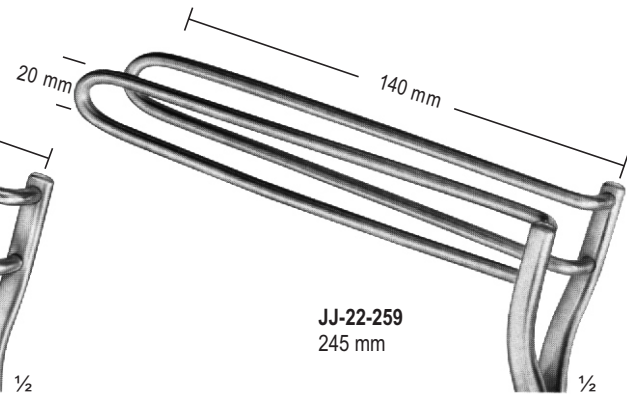

JJ-22-259
245 mm



1/2

JJ-22-260
PRATT
205 mm

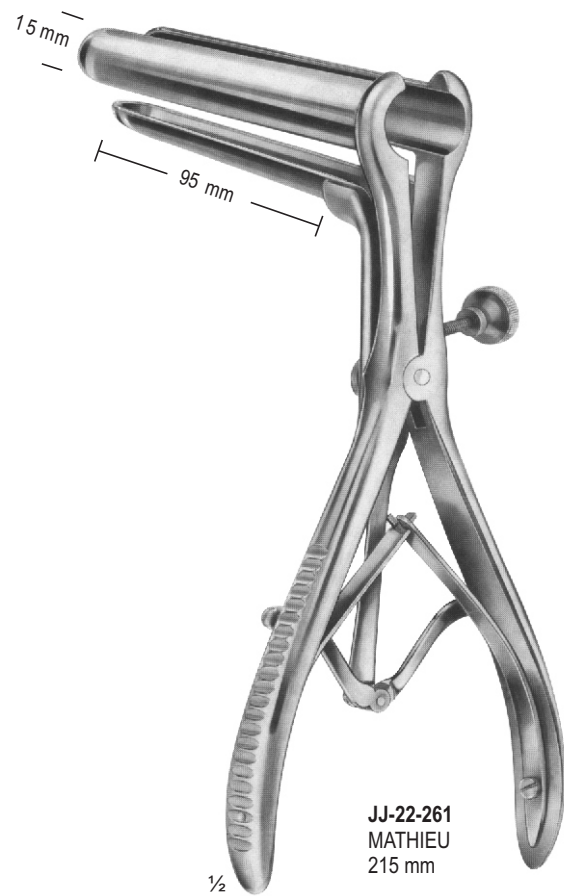

1/2

JJ-22-261
MATHIEU
215 mm

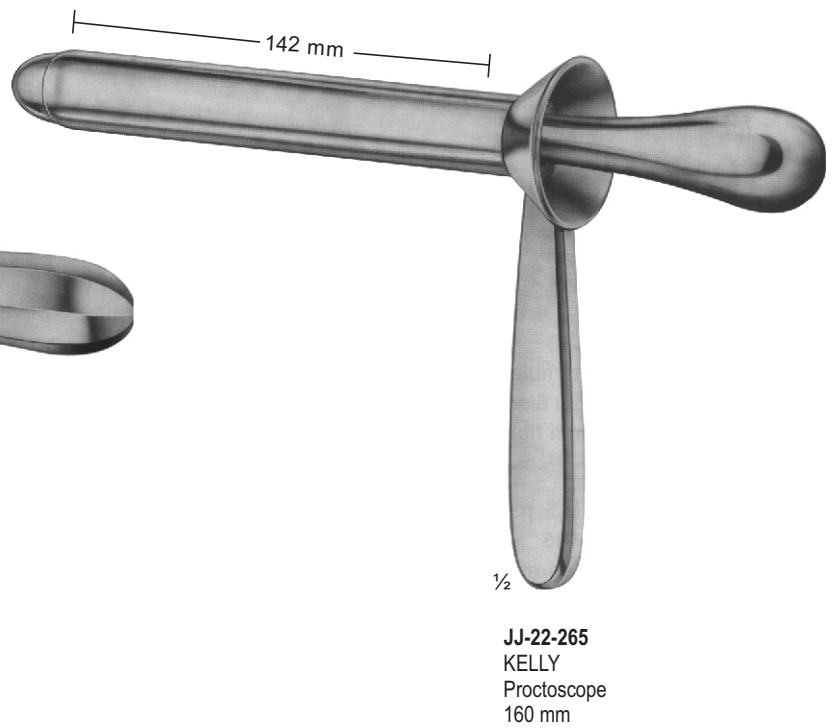
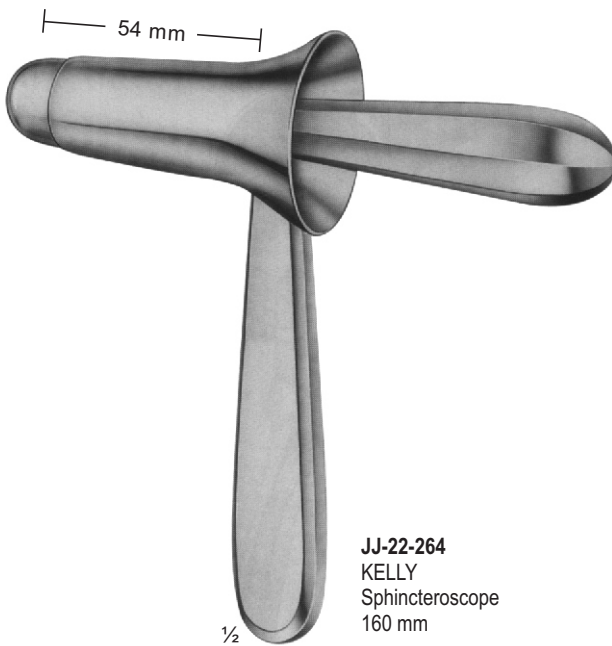
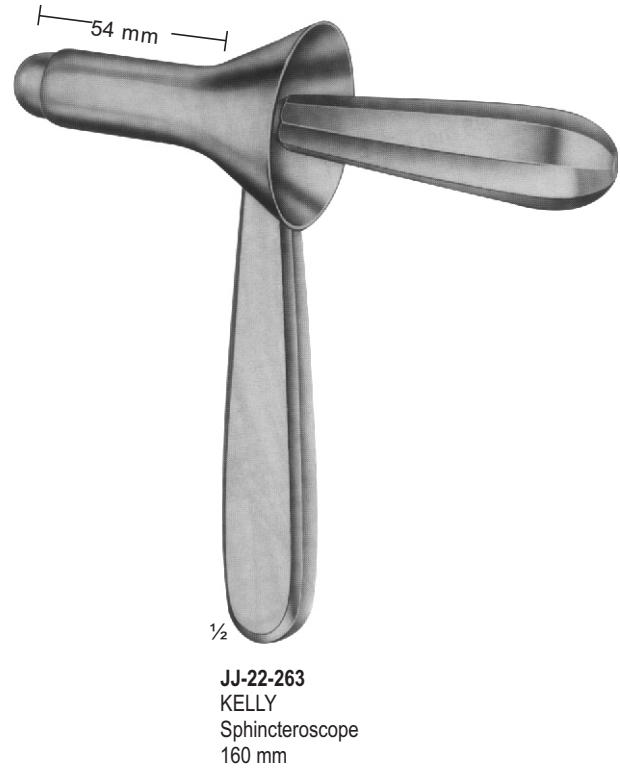

BIOPSY FORCEPS FOR RECTUM

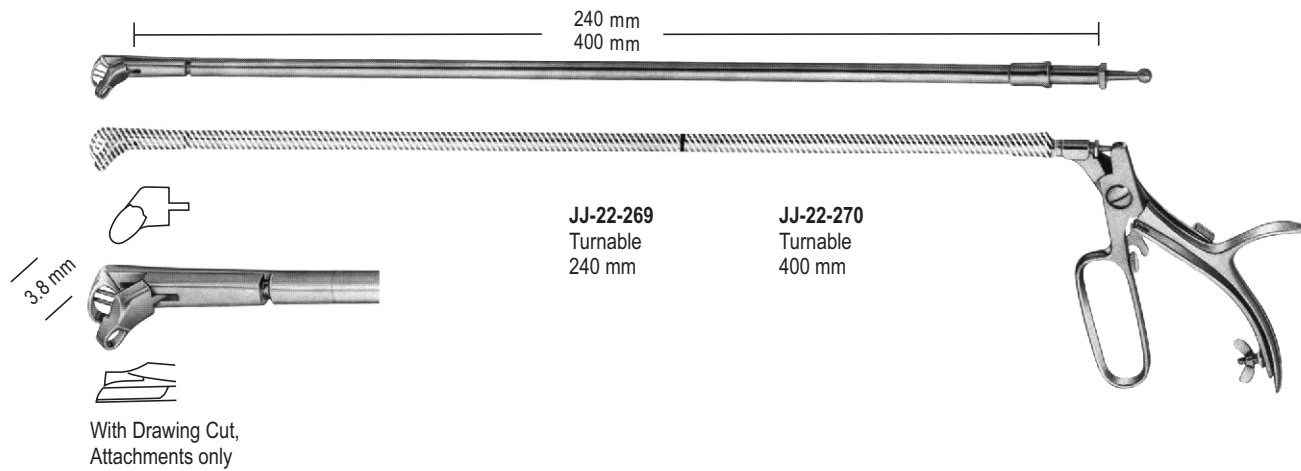
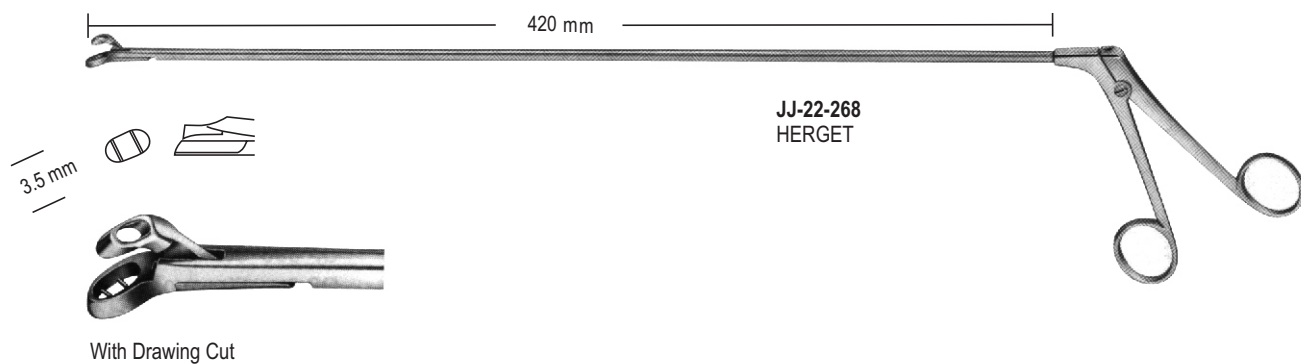
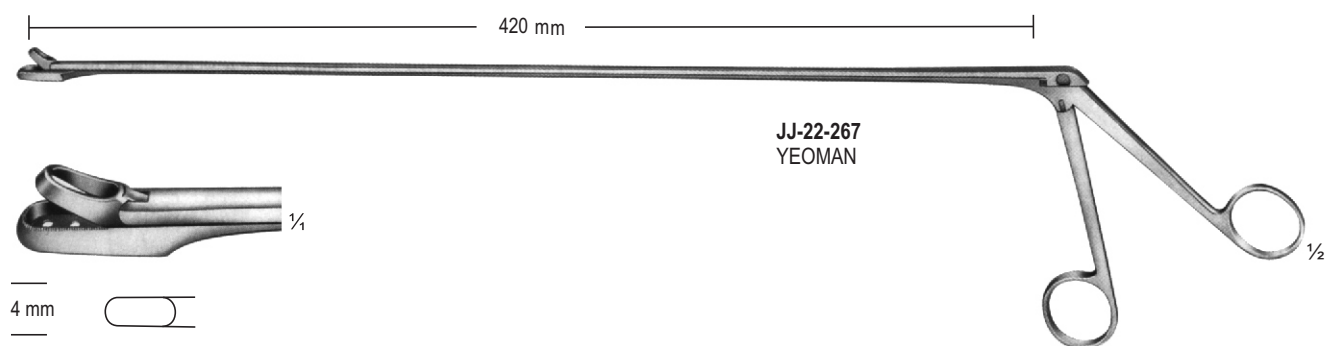
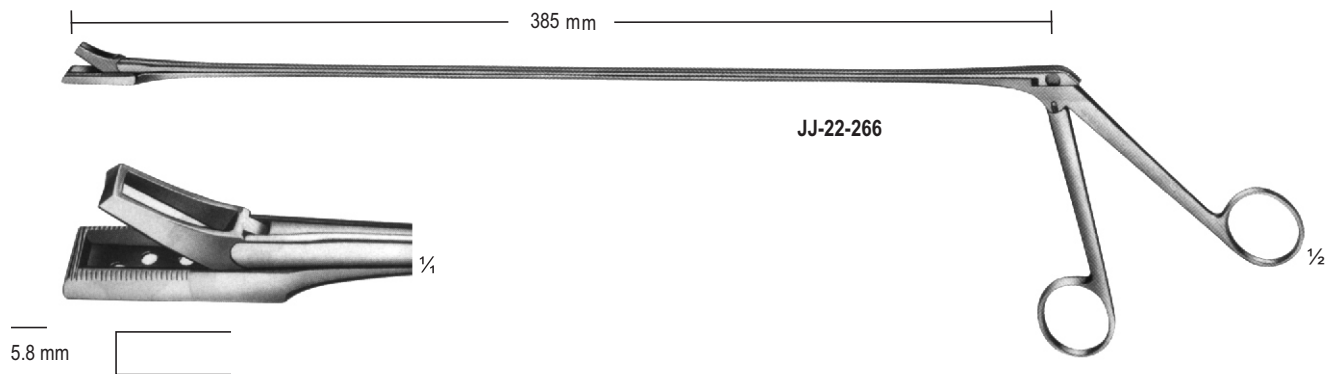



JJ-22-271
LOWER
180 mm



JJ-22-272
LAHEY (SWEET)
190 mm



JJ-22-273
LAHEY
220 mm

GALL DUCT FORCEPS



JJ-22-274
DESJARDINS
Gall duct-and cystic forceps
210 mm

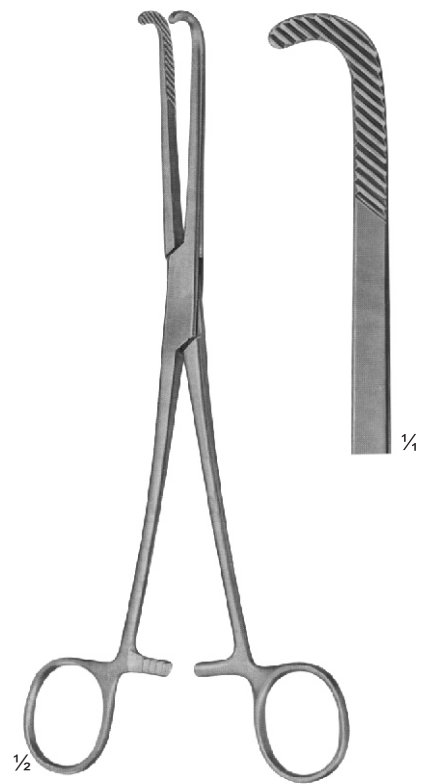

JJ-22-275
NISSEN
Gall duct-and cystic forceps
215 mm



JJ-22-276 - JJ-22-277
GRAY
180 mm

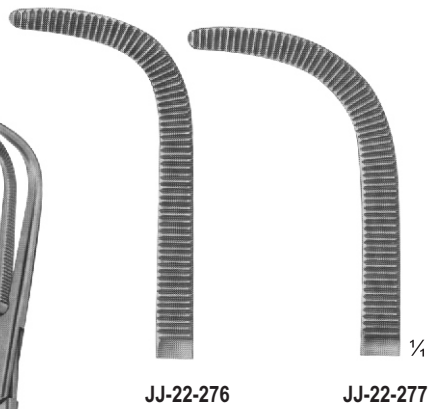

JJ-22-278 - JJ-22-279
MIXTER
Gall duct-and cystic forceps
230 mm

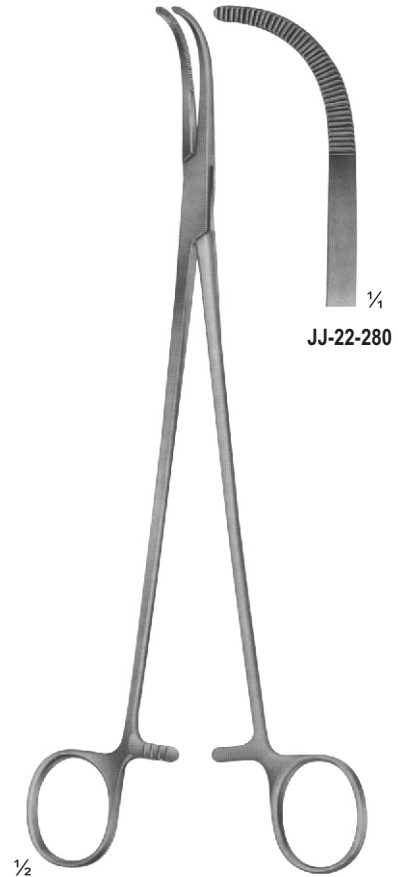
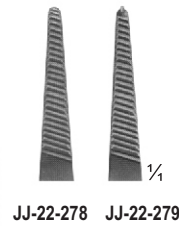

JJ-22-280
FOERSTER-BALLENGER
240 mm



KIDNEY CLAMPS

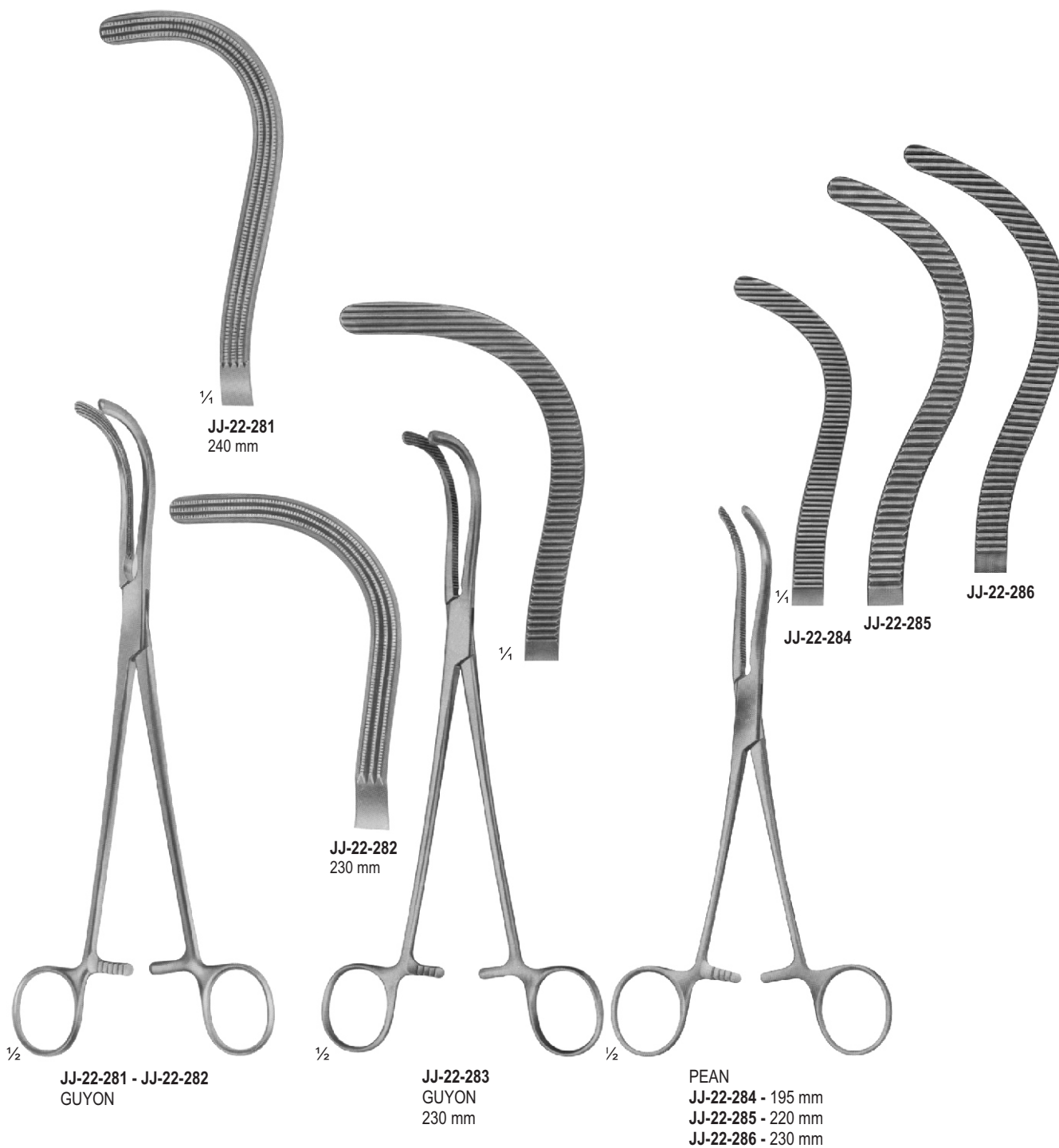

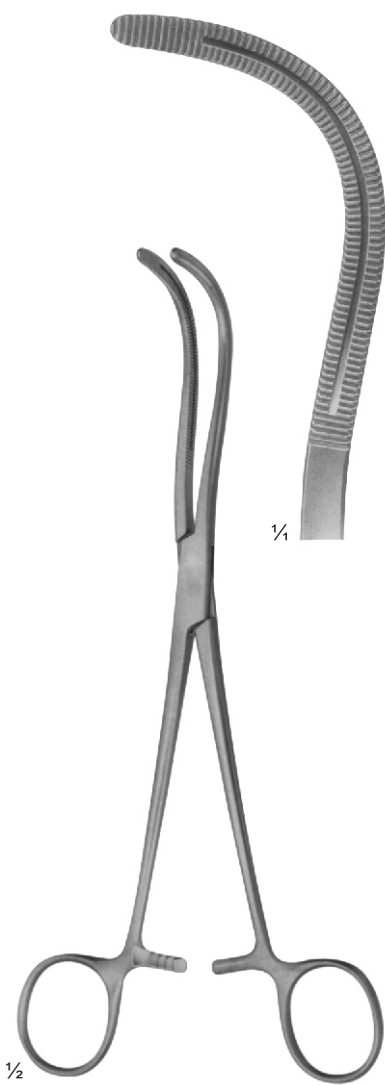

JJ-22-287
STILLE
220 mm

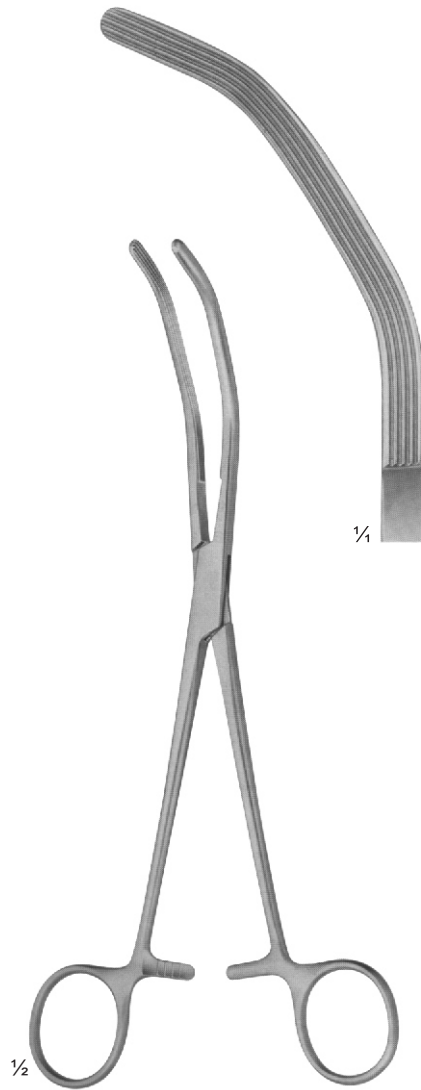

JJ-22-288
HERRICK
225 mm

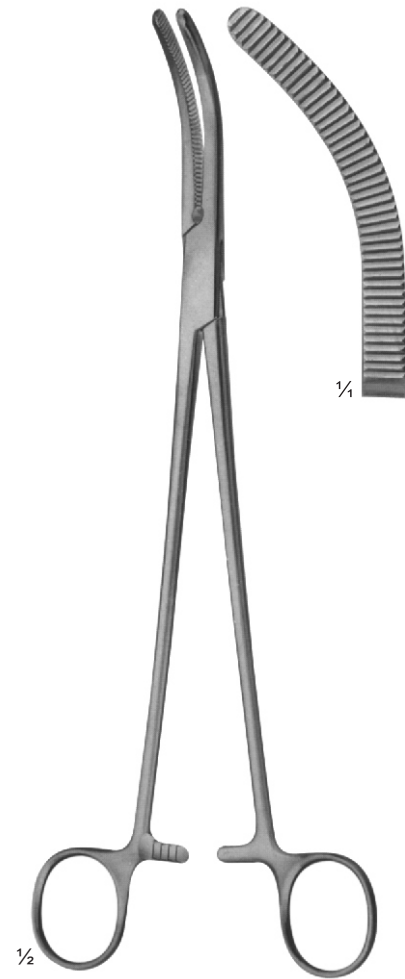

JJ-22-289
WERTHEIM
225 mm

Page
535–551

▪ Micro Instruments

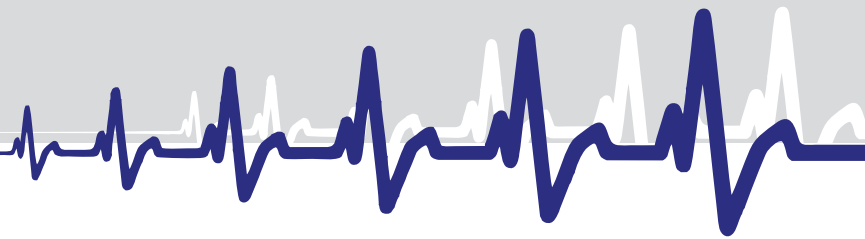

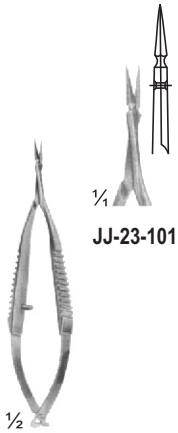

JJ-23-101



JJ-23-102



JJ-23-103



JJ-23-104

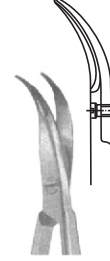

JJ-23-105



1/2

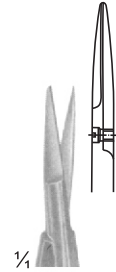

1/4

JJ-23-101 - JJ-23-103
VANNAS
85 mm

JJ-23-104 - JJ-23-105
CASTROVIEJO
95 mm

JJ-23-106
NOYES
125 mm

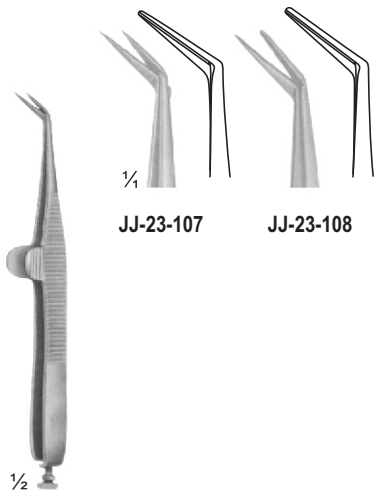

JJ-23-107

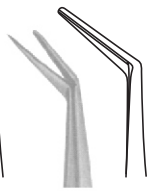

JJ-23-108

1/2

JJ-23-107 - JJ-23-108
WECKER
Eye Scissor
110 mm

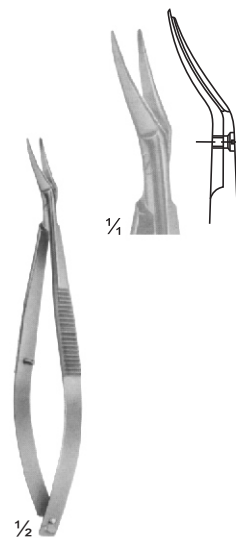

1/4

1/2

JJ-23-109
CASTROVIEJO
Eye Scissor
115 mm

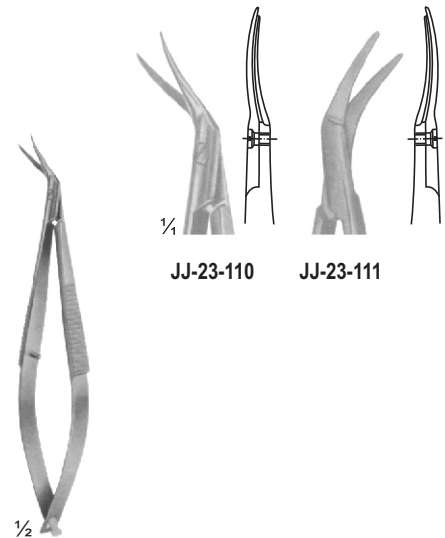

1/4

1/2

JJ-23-110 - JJ-23-111
CASTROVIEJO
Eye Scissor
110 mm

JJ-23-110

JJ-23-111

MICRO SCISSORS "SPRING TYPE" FLAT HANDLES

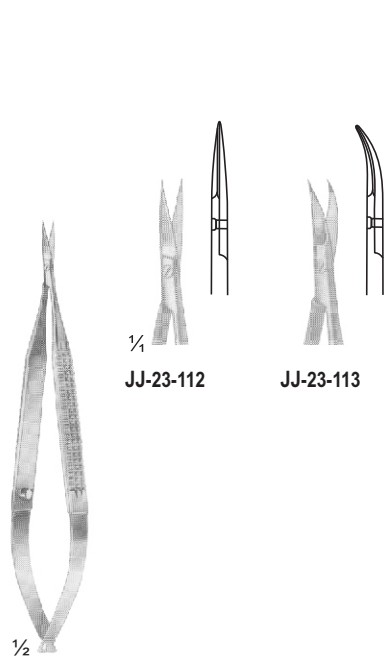

JJ-23-112 - JJ-23-113
120 mm

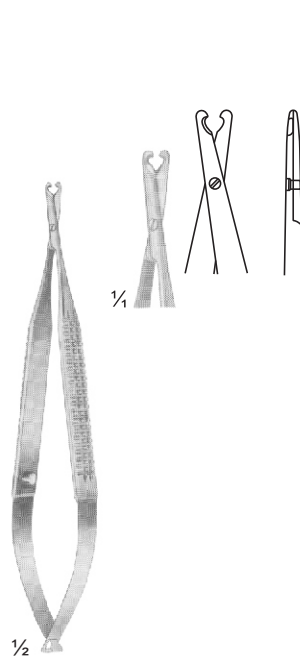

JJ-23-114
BIEMER
Vein Scissor
130 mm

JJ-23-115
160 mm

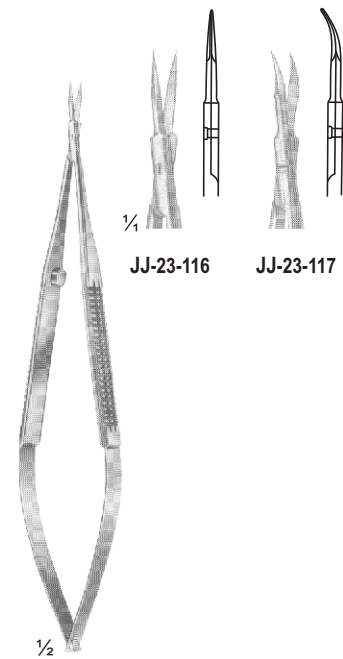

JJ-23-116 - JJ-23-117
VANNAS
160 mm

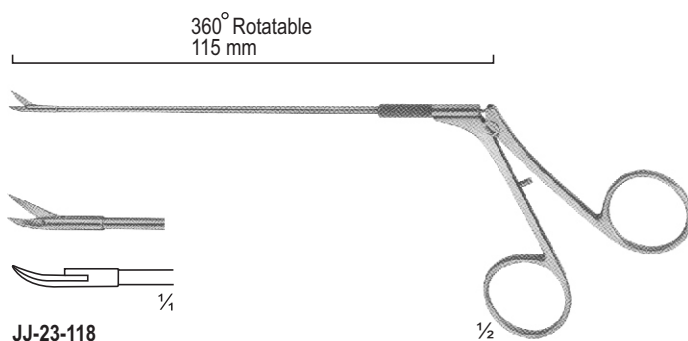

JJ-23-118
CASPAR
Micro Scissor Curved
115 mm

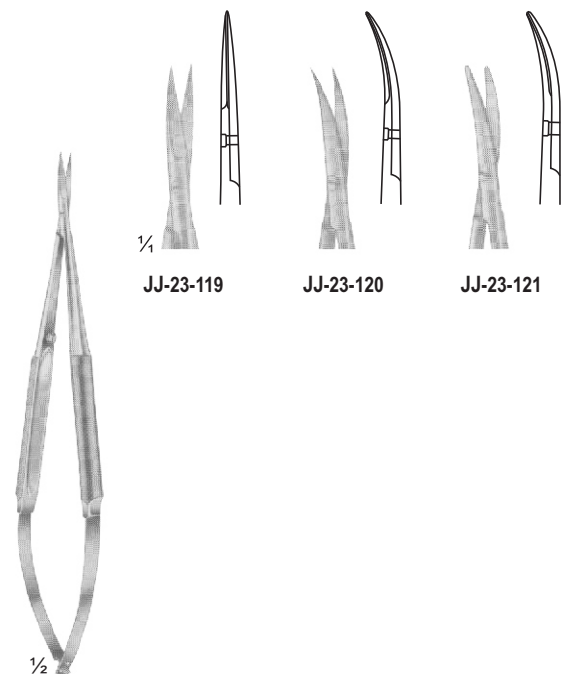

JJ-23-119 - JJ-23-121
Micro Dissecting Scissor
145 mm

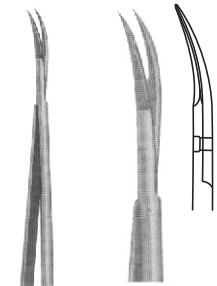

1/2
JJ-23-122
YASARGIL
245 mm

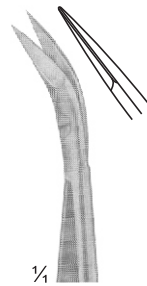

1/4
JJ-23-123

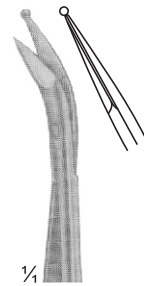

1/4
JJ-23-124

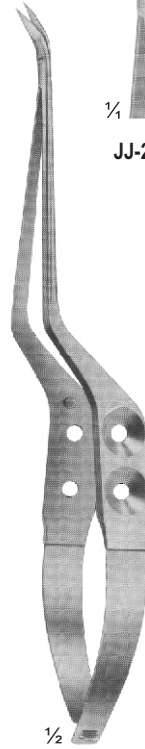

1/2
JJ-23-123 - JJ-23-124
Laterally Angled
200 mm

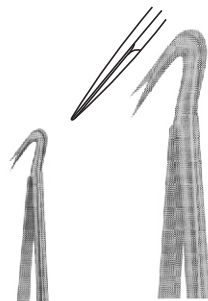

1/2
JJ-23-125
Laterally Angled
190 mm

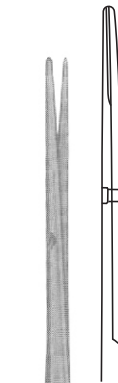

1/4
JJ-23-126

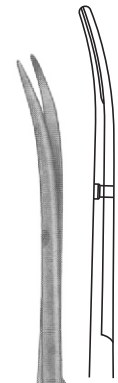

1/4
JJ-23-127



1/2
JJ-23-126 - JJ-23-127
YASARGIL
225 mm

MICRO SPRING SCISSORS



JJ-23-128

JJ-23-128 - JJ-23-129
CASTROVIEJO
Spring Scissors
15, 18 cm



JJ-23-129



JJ-23-130

JJ-23-130 - JJ-23-132
STREAMLINE
Micro Coronary
Scissors
15, 18, 21, 23 cm



JJ-23-131



JJ-23-132



JJ-23-133

JJ-23-133
STREAMLINE
Spring Scissors
23 cm



JJ-23-134

JJ-23-134 - JJ-23-135
STREAMLINE
Spring Scissors
23 cm



JJ-23-135



JJ-23-136

JJ-23-136 - JJ-23-137
TOLEDO
Spring Scissors
16.5 cm



JJ-23-137

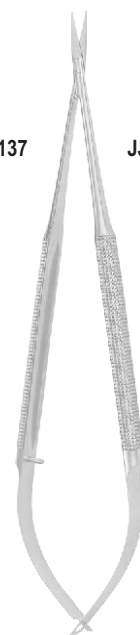

JJ-23-138

JJ-23-138 - JJ-23-139
BARRAQUER
Spring Scissors
12, 15, 18 cm



JJ-23-139

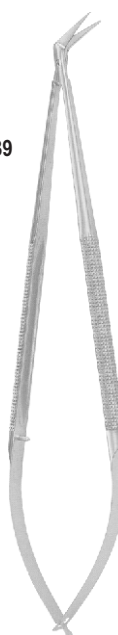

JJ-23-140

JJ-23-140 - JJ-23-144
BARRAQUER
Spring Scissors
18 cm

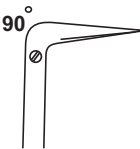

JJ-23-143

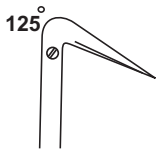
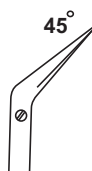

JJ-23-144

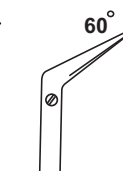

JJ-23-142



JJ-23-145

JJ-23-145 - JJ-23-147
BARRAQUER
Spring Scissors
Bayonet
22 cm



JJ-23-146



JJ-23-147

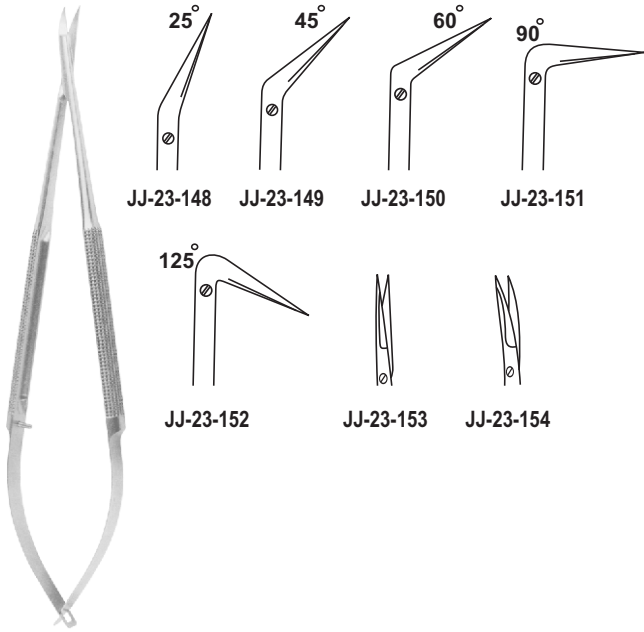

JJ-23-148 - JJ-23-154
STREAMLINE
Spring Scissors
18, 21 cm



JJ-23-155
ONG-TREUMER
Capsulotomy Scissors
8 cm



JJ-23-156
VANNAS-TUBINGEN
After-Cataract Scissors
8 cm
8 mm

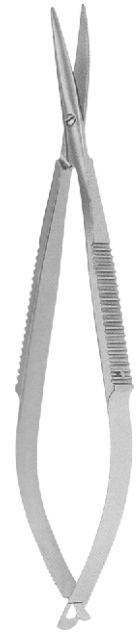

JJ-23-157
WESTCOTT
Tenotomy Scissors
11 cm



JJ-23-158
WESTCOTT
Micro-Tenotomy
Scissors
10.5 cm



JJ-23-159
Micro Spring
Scissors
10.5 cm
12 mm



JJ-23-160
CASTROVIEJO
Corneal Scissors
10.5 cm



JJ-23-161
TROUTMAN
Corneal Scissors
10 cm

SCISSORS AND MICRO FORCEPS



JJ-23-162
BONN
 Eye Scissors
 9 cm



JJ-23-163
 Eye Scissors
 10.6 cm

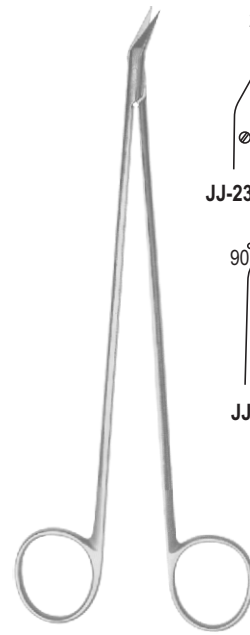

JJ-23-164 - JJ-23-168
HEGEMANN
 Ring Scissors
 18 cm

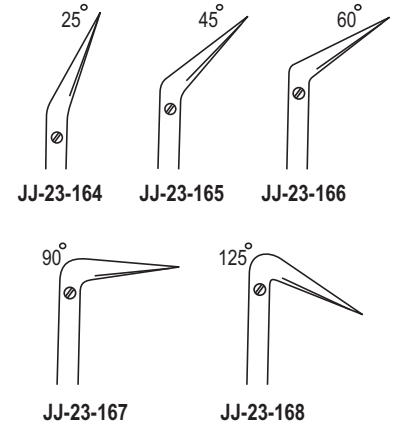

JJ-23-169 - JJ-23-173
TOLEDO
 Forceps Heavy
 18, 21 cm

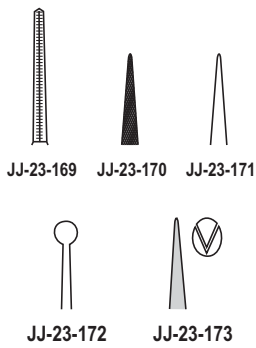

JJ-23-174 - JJ-23-178
 Forceps
 15, 18 cm

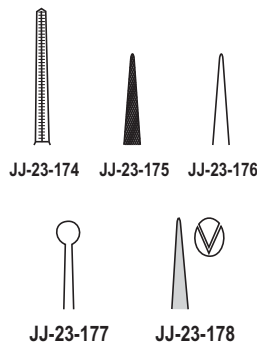

JJ-23-179 - JJ-23-183
TOLEDO
 Forceps
 18, 21 cm

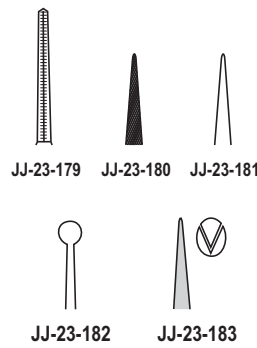

JJ-23-184 - JJ-23-188
 15, 18, 21 cm

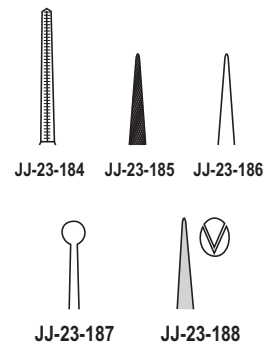

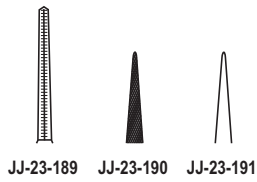

JJ-23-189 JJ-23-190 JJ-23-191

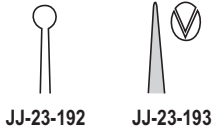

JJ-23-192 JJ-23-193

JJ-23-189 - JJ-23-193
Forceps
15, 18, 21 cm

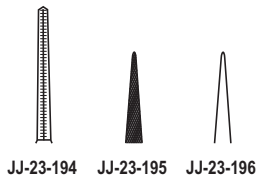

JJ-23-194 JJ-23-195 JJ-23-196

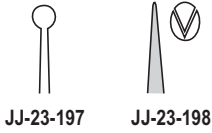

JJ-23-197 JJ-23-198

JJ-23-194 - JJ-23-198
15, 18, 21 cm

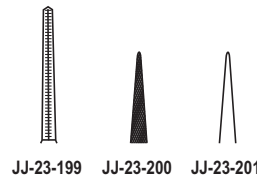

JJ-23-199 JJ-23-200 JJ-23-201

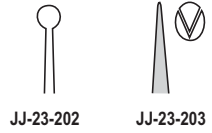

JJ-23-202 JJ-23-203

JJ-23-199 - JJ-23-203
Forceps
15, 18, 21 cm

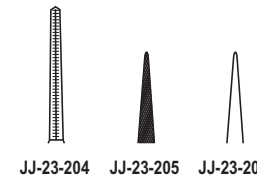
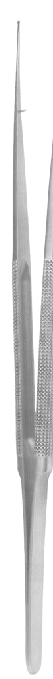

JJ-23-204 JJ-23-205 JJ-23-206



JJ-23-207 JJ-23-208

JJ-23-204 - JJ-23-208
Forceps
15, 18, 21 cm

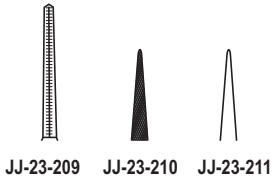

JJ-23-209 JJ-23-210 JJ-23-211

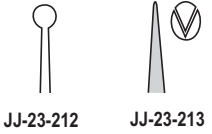

JJ-23-212 JJ-23-213

JJ-23-209 - JJ-23-213
Forceps Counter
Balance
15, 18, 21 cm

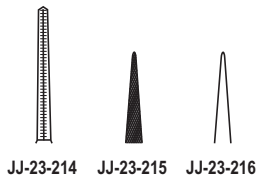

JJ-23-214 JJ-23-215 JJ-23-216

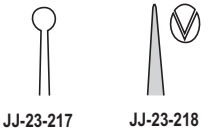

JJ-23-217 JJ-23-218

JJ-23-214 - JJ-23-218
Forceps Counter
Balance
15, 18, 21,
23, 25 cm

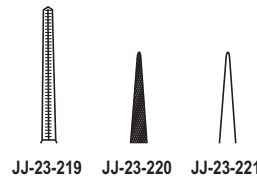

JJ-23-219 JJ-23-220 JJ-23-221

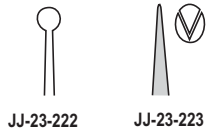

JJ-23-222 JJ-23-223

JJ-23-219 - JJ-23-223
Forceps
15, 21, 23 cm

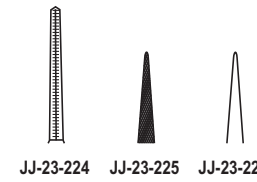

JJ-23-224 JJ-23-225 JJ-23-226

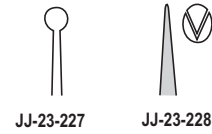

JJ-23-227 JJ-23-228

JJ-23-224 - JJ-23-228
Forceps
18, 21 cm

DELICATE TISSUE FORCEPS

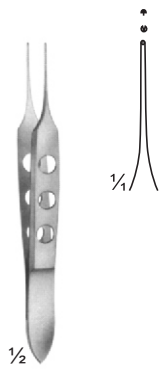

BISHOP-HARMON
JJ-23-229
 8.5 cm

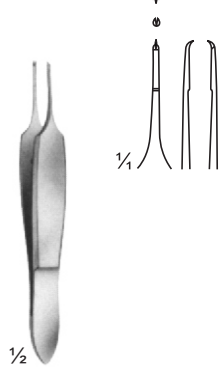

ST. MARTIN
JJ-23-230
 8 cm

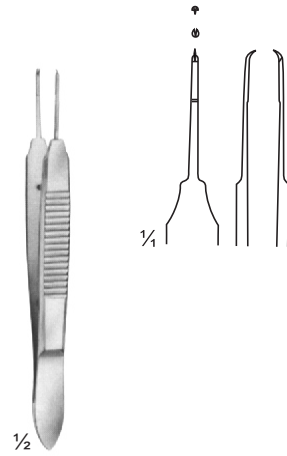

CASTROVIEJO
JJ-23-231
 teeth 0.9 mm
 10 cm

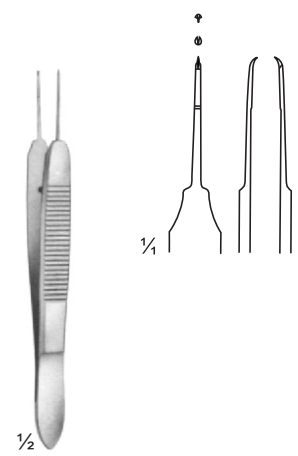

CASTROVIEJO
JJ-23-232
 teeth 0.5 mm
 10 cm

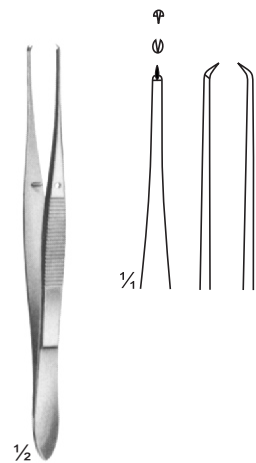

ELSCHING
JJ-23-233
 11 cm

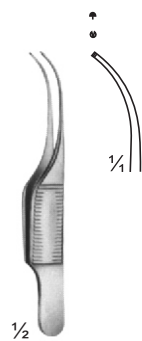

GILL
JJ-23-234
 7.5 cm

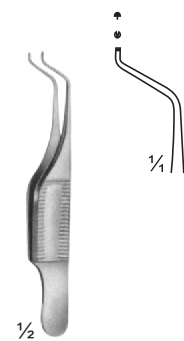

GILL - HESS
JJ-23-235
 7.5 cm

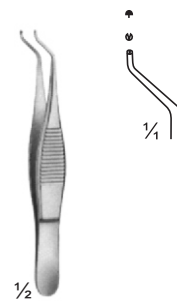

HESS
JJ-23-236
 7 cm

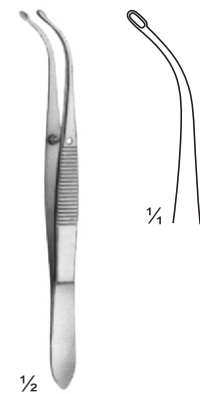

ARRUGA
JJ-23-237
 10 cm

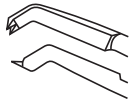

JJ-23-238

JJ-23-238
Colibri Forceps With
Tying Platform
8 cm



JJ-23-239
Utility Forceps
10 cm

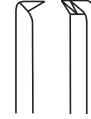

JJ-23-240

JJ-23-240 - 141
TUBINGEN
Suture Forceps
8.5, 11 cm

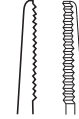

JJ-23-241



JJ-23-242
BONN
Suture Forceps
7.5 cm



JJ-23-243
BONN
Iris Forceps
8 cm

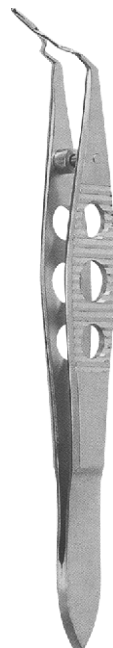

JJ-23-244
McDonalds-Spaleck
Lense Implantation
Forceps Crossaction
10 cm
5, 6 mm

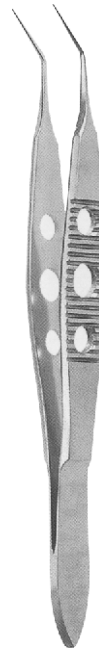

JJ-23-245
FAULKNER
Holding Forceps
10 cm
5, 6, 11 mm



JJ-23-246
Spaleck-microma
Lense Implantation
Forceps
10 cm
5.6, 6.6 mm

MICRO HOOKS, SHARP INSTRUMENTS AND EYE RETRACTOR



JJ-23-247
Hook



JJ-23-248
JAMESON
Strabismus Hook



JJ-23-249
GRAEFE
Strabismus Hook
13, 14 cm



JJ-23-250
GRAEFE
Iris Hook



JJ-23-251
GILLES
Skin Hook



JJ-23-252
GUTHRIE
Fixation Hook,
double



JJ-23-253
MEYHOFER
Spoon



JJ-23-254
KUHN
Corneal Scarifier



JJ-23-255
GRAEFE
Scarifier



JJ-23-256
Foreign Body
Needle



JJ-23-257
HAMBURG
Air Keratome

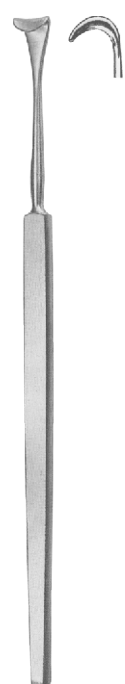

JJ-23-258
DESMARRES
Eye Retractor



JJ-23-259
BOWMAN
Lachrymal
Probes



JJ-23-260
WILDER
Lachrymal
Probes



JJ-23-261
WEISS
Eye Speculum



JJ-23-262
CASTROVIEJO
Eye Speculum

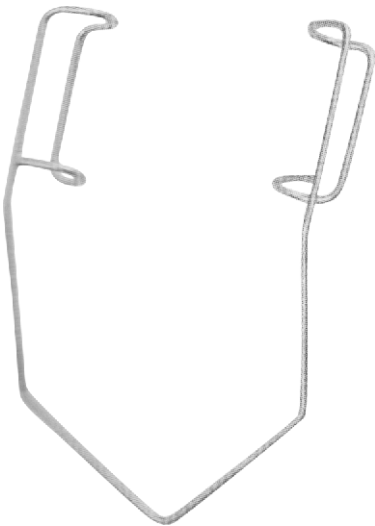

JJ-23-263
BARRAQUER
Eye Speculum

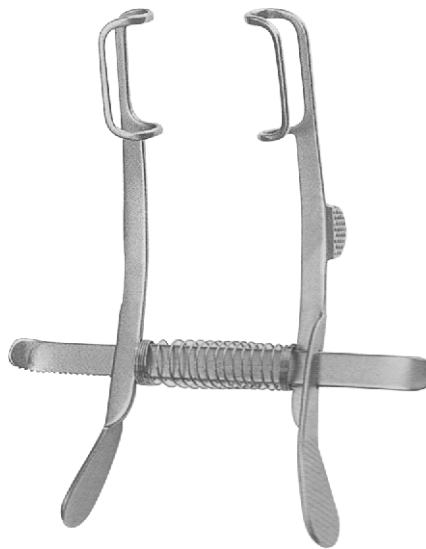

JJ-23-264
MELLINGER
Eye Speculum

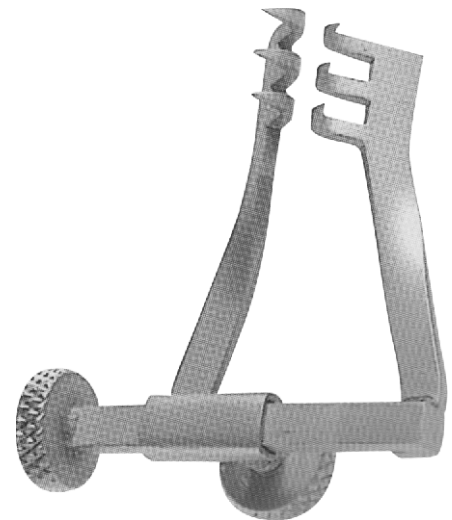

JJ-23-265
MINIGOLDSTEIN
Self-Retaining Retractors
3 Teeth
2 cm

SELF RETAINING RETRACTORS

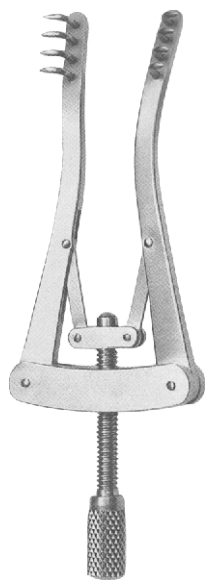

JJ-23-266
ALM
Self-Retaining Retractors
4 Teeth
7 cm

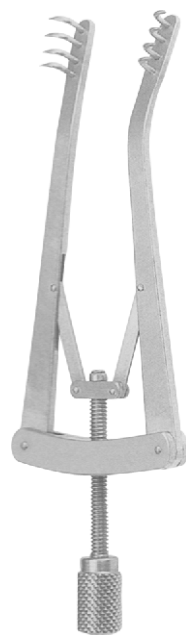

JJ-23-267
ALM
Self-Retaining Retractors
4 Teeth
10 cm

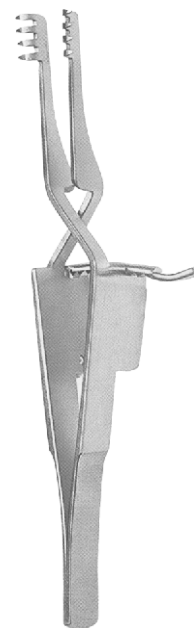

JJ-23-268
HOLTZHEIMER
Self-Retaining Retractors
4 Teeth
10 cm



JJ-23-269
HOLTZHEIMER
Self-Retaining Retractors
4 Teeth
10 cm

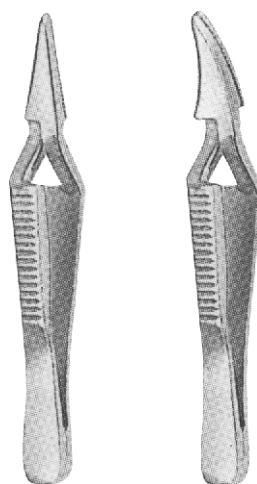

JJ-23-270
Cross Action
Forceps
28 mm

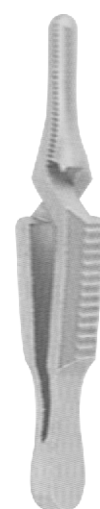

JJ-23-271
Cross Action
Forceps
35 mm

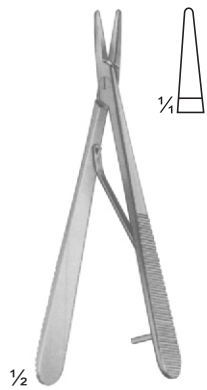

JJ-23-272
ROHRSCHEIDER
With copper inserts
100 mm



JJ-23-273
KALT
With catch
135 mm

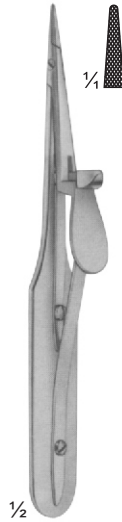

JJ-23-274
ARRUGA
With catch
135 mm



JJ-23-275 - 176
CASTROVIEJO
With catch
145 mm



JJ-23-277 - 178
CASTROVIEJO
Without Catch
160 mm

NEEDLE HOLDERS FOR MICRO SURGERY

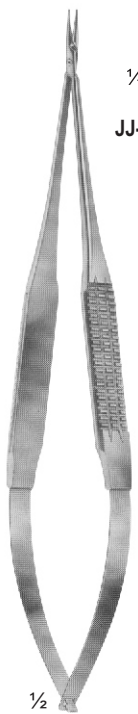

$\frac{1}{4}$
JJ-23-279

$\frac{1}{4}$
JJ-23-280

JJ-23-279 - JJ-23-280
 Without catch
 185 mm

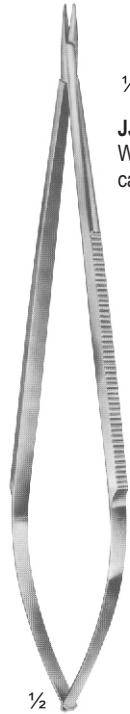

$\frac{1}{4}$
JJ-23-281
 Without catch

$\frac{1}{4}$
JJ-23-282
 With catch

JJ-23-281 - JJ-23-282
 JACOBSON
 185 mm

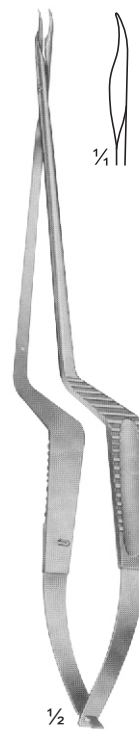

JJ-23-283
 Without catch
 195 mm



$\frac{1}{4}$
JJ-23-284

$\frac{1}{4}$
JJ-23-285

JJ-23-284 - JJ-23-285
 YASARGIL
 With catch
 200 mm



JJ-23-286
115 mm



JJ-23-287
135 mm

JJ-23-286 - JJ-23-287
BARRAQUER
Without catch



JJ-23-288



JJ-23-289

JJ-23-288 - JJ-23-289
BARRAQUER
Without catch
120 mm



JJ-23-290



JJ-23-291

JJ-23-290 - JJ-23-291
BARRAQUER
Without catch
120 mm



JJ-23-292



JJ-23-293

JJ-23-292 - JJ-23-293
BARRAQUER
Without Catch
150 mm

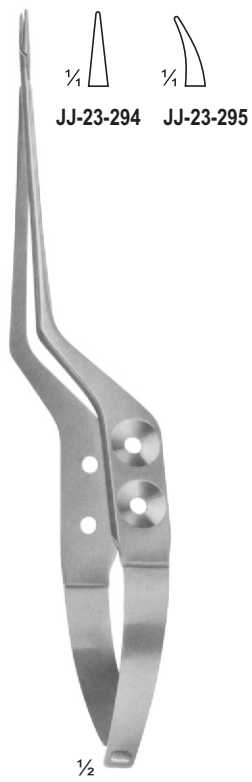

JJ-23-294 - JJ-23-295
YASARGIL
200 mm



JJ-23-296 - JJ-23-297
YASARGIL
225 mm



JJ-23-298
YASARGIL
245 mm



JJ-23-299



JJ-23-300



JJ-23-301



JJ-23-302



CASTROVIEJO
JJ-23-299 - JJ-23-302
145 mm



JJ-23-303



JJ-23-304



JJ-23-305



JJ-23-306

CASTROVIEJO
JJ-23-303 - JJ-23-306
180 mm



JJ-23-307



JJ-23-308



JJ-23-309



JJ-23-310

BARRAQUER
JJ-23-307 - JJ-23-310
145 mm



HEPP SCHEIDEL
JJ-23-311
180 mm

Page
552–564

▪ Suction Instruments

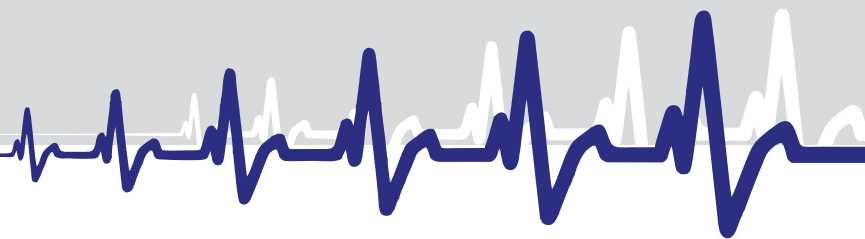

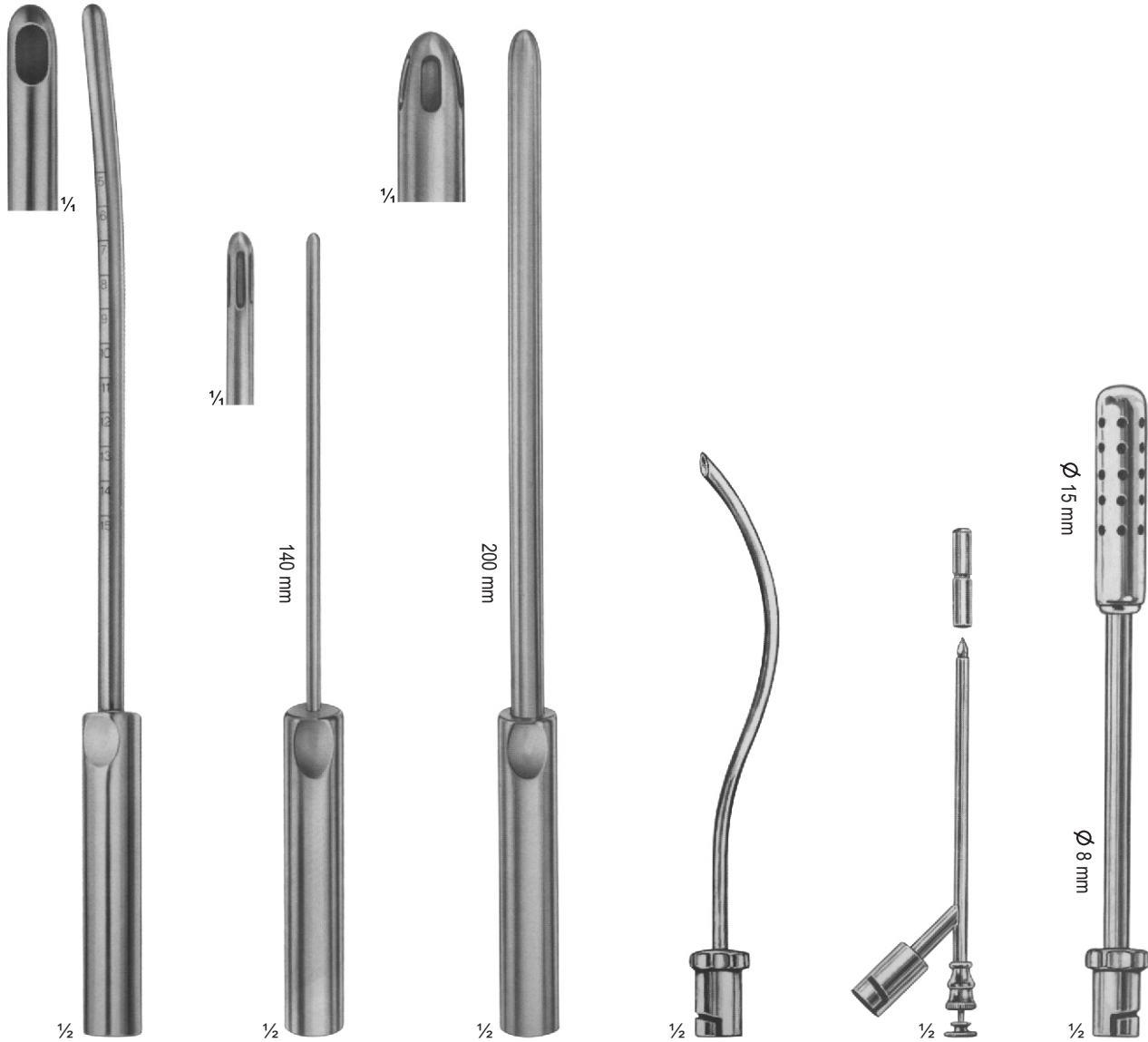

JJ-24-101 - JJ-24-106
BIEMER
JJ-24-101 ø 4 mm
JJ-24-102 ø 6 mm
JJ-24-103 ø 8 mm
JJ-24-104 ø 10 mm
JJ-24-105 ø 12 mm
JJ-24-106 ø 14 mm
 Currettes for aspiration lipectomy, graduated, slightly curved

JJ-24-107 - JJ-24-108
BIEMER
JJ-24-107 ø 4 mm
JJ-24-108 ø 6 mm
 Currettes for aspiration lipectomy, with three apertures, slightly curved malleable

JJ-24-109 - JJ-24-111
BIEMER
JJ-24-109 ø 8 mm
JJ-24-110 ø 10 mm
JJ-24-111 ø 12 mm
 Currettes for aspiration lipectomy, with three apertures, slightly curved malleable

JJ-24-112
For aspirating fluid from the excretory ducts of large glands and for keeping the operating area clear
170 mm

JJ-24-113
Trocar
For puncturing
150 mm

JJ-24-114
For clearing large quantities of fluid
190 mm

SUCTION INSTRUMENTS



JJ-24-115
Trocar
For puncturing
170 mm

JJ-24-116
Hollow needle,
sharp
150 mm

JJ-24-117
double curved
For general
surgery
230 mm

JJ-24-118
For tonsillectomy,
oral and laryngeal
operations
190 mm

JJ-24-119
For tonsillectomy,
oral and laryngeal
operations
220 mm

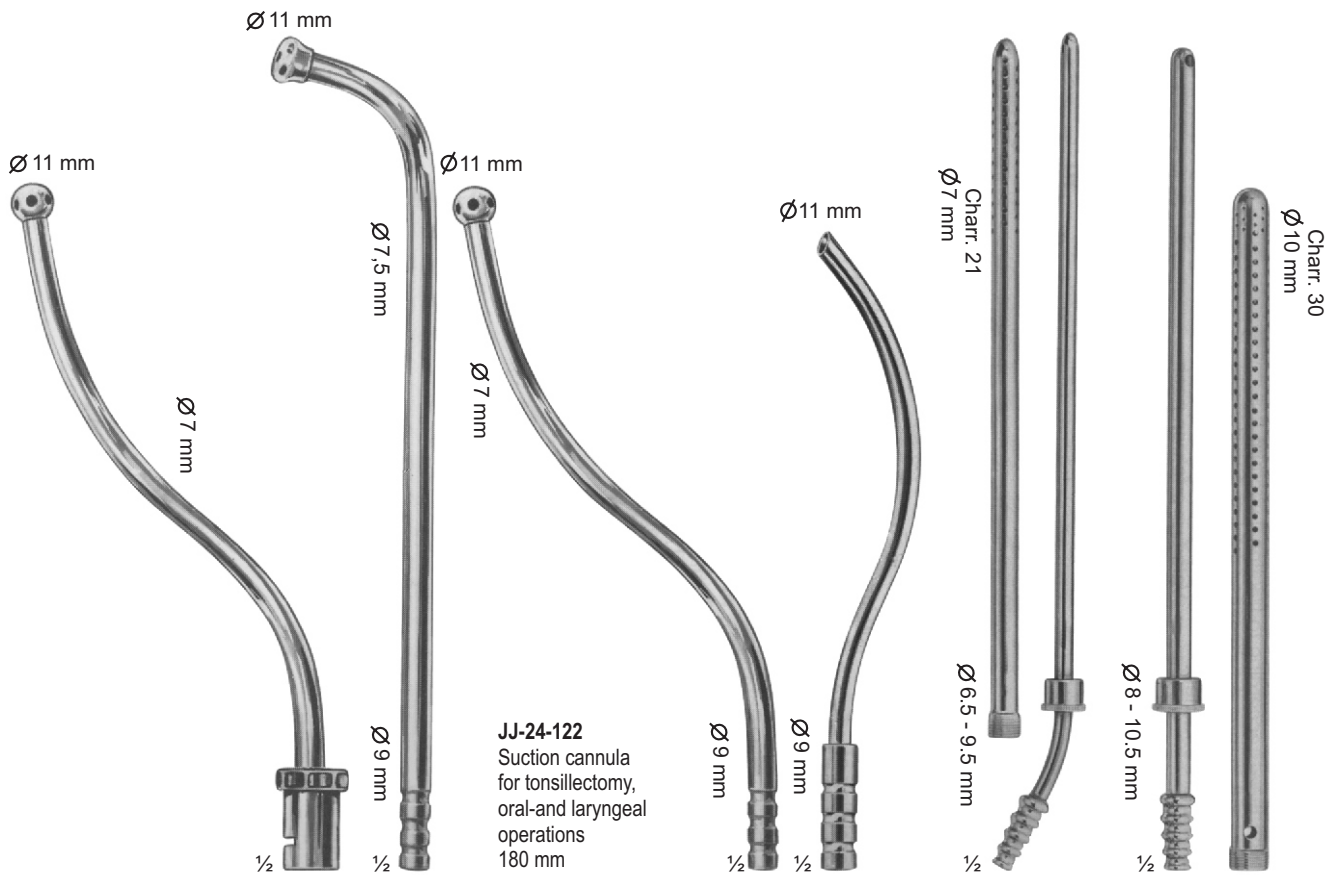

JJ-24-120
For tonsillectomy,
oral-and laryngeal
operations
180 mm

JJ-24-121
Suction cannula
for tonsillectomy,
oral-and laryngeal
operations
220 mm

JJ-24-122
Suction cannula
for tonsillectomy,
oral-and laryngeal
operations
180 mm

JJ-24-123
S-shaped blunt cannula
for aspirating fluid from
the excretory ducts of
large glands and for
keeping the operations
area clear
170 mm

JJ-24-124
POOL
Suction cannula,
with outer tube
to be screwed of
225 mm

JJ-24-125
POOL
Suction cannula,
with outer tube
to be screwed of
225 mm

SUCTION INSTRUMENTS

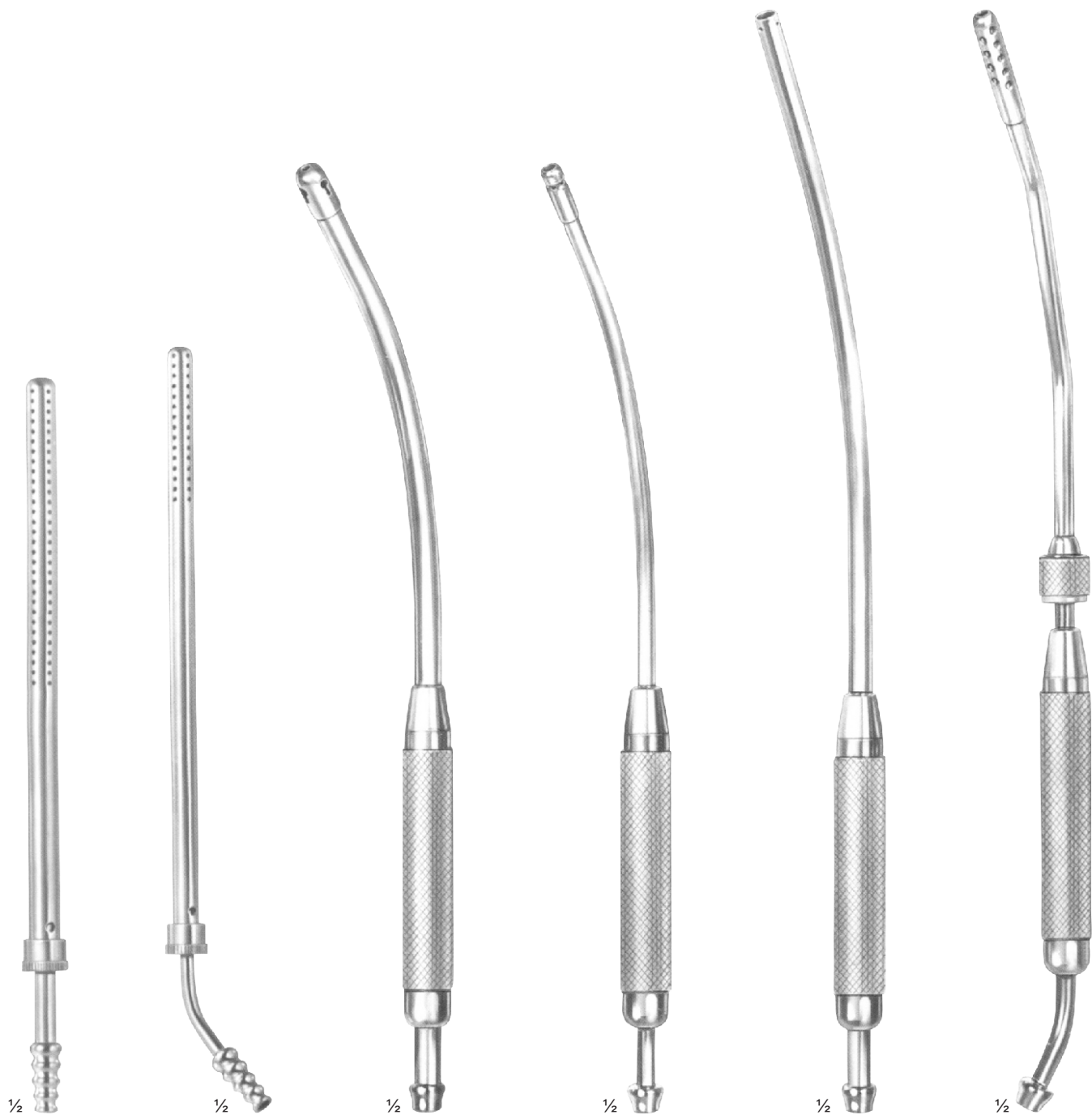

POOLE
JJ-24-126
24 cm
Ø10 mm

POOLE
JJ-24-127
25 cm
Ø 8 mm

COLLEY
JJ-24-128
with perforated screw tip
31 cm
Ø10 mm

COLLEY
JJ-24-129
with perforated screw tip
31 cm
Ø7 mm

COLLEY
JJ-24-130
36 cm
Ø 8 mm

COLLEY
JJ-24-131
with perforated
screw tip
36 cm
Ø 8 mm



DE-BAKEY
JJ-24-132
with finger cut-off
and stylet
16 cm



NUBOER
JJ-24-133
round opening
21 cm
Ø 10 mm
½



NUBOER
JJ-24-134
oval opening
21 cm
Ø 6 mm
½

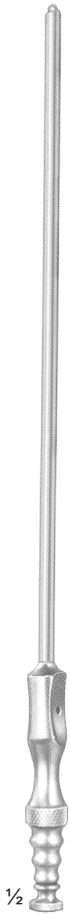

FRAZIER
JJ-24-135
24 cm
Ø 3.3 mm



ADSON
JJ-24-136
20 cm
Ø 4 mm



○
JJ-24-137
9 cm
Ø 1.5 mm



○
JJ-24-138
9 cm
Ø 2 mm

○
JJ-24-139
9 cm
Ø 2.5 mm

¼ ○
JJ-24-140
9 cm
Ø 3.5 mm

COUPLAND
JJ-24-137 - JJ-24-140
with tube connector
17 cm



○
JJ-24-141
9 cm
Ø 3 mm

○
JJ-24-142
9 cm
Ø 3.5 mm

¼ ○
JJ-24-143
9 cm
Ø 4.3 mm

BYRD
JJ-24-141 - JJ-24-143
with tube connector
17 cm



COGSWELL
JJ-24-144
with finger cut-off
24.5 cm
Ø 3.8 mm

SUCTION INSTRUMENTS

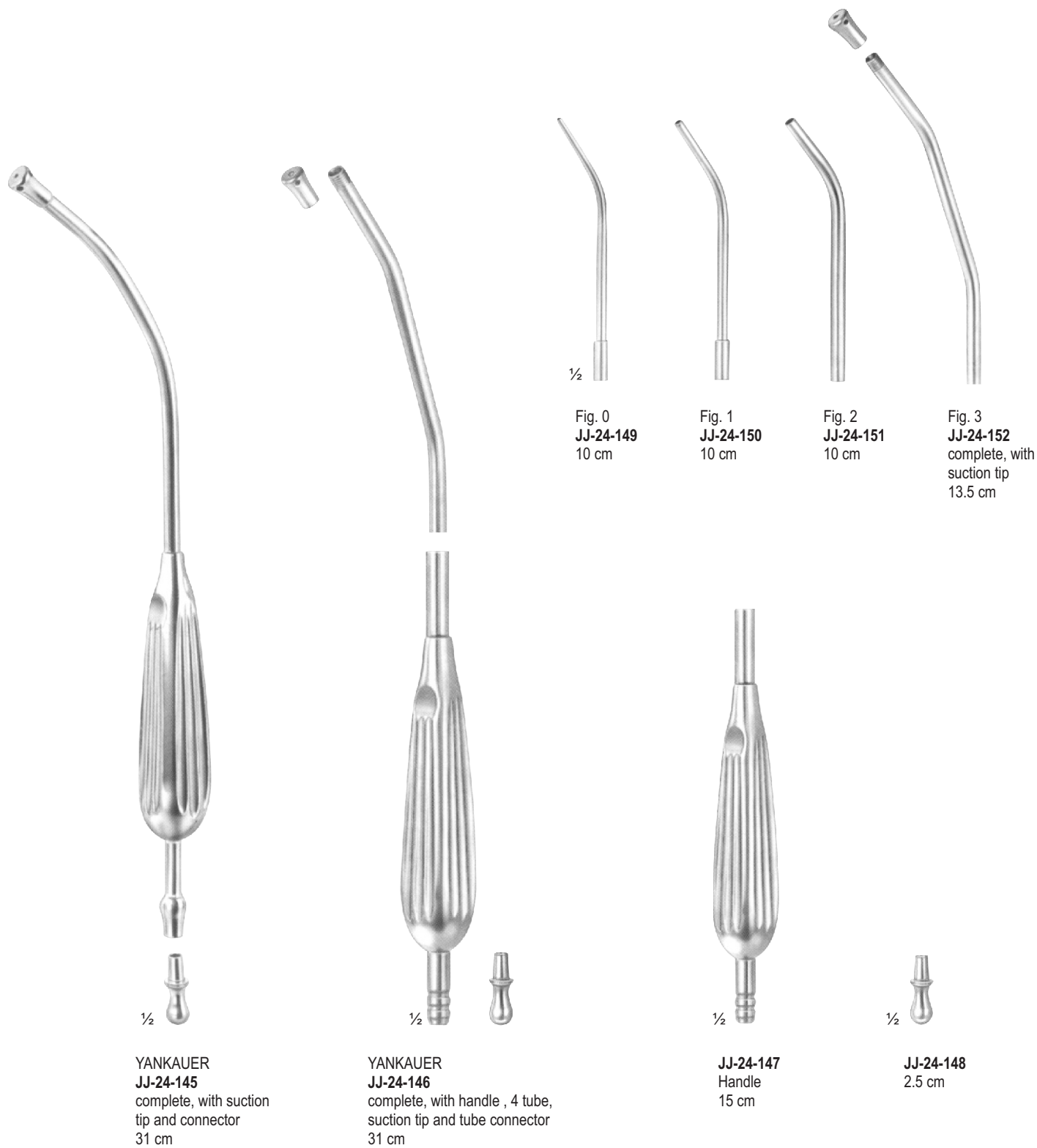

**YANKAUER
JJ-24-145**
complete, with suction
tip and connector
31 cm

**YANKAUER
JJ-24-146**
complete, with handle , 4 tube,
suction tip and tube connector
31 cm

JJ-24-147
Handle
15 cm

JJ-24-148
2.5 cm

**Fig. 0
JJ-24-149**
10 cm

**Fig. 1
JJ-24-150**
10 cm

**Fig. 2
JJ-24-151**
10 cm

**Fig. 3
JJ-24-152**
complete, with
suction tip
13.5 cm

WULLSTEIN
JJ-24-153
Suction tube, conical, silver, oliver
with LUER hub
16 cm

Ø1,75 mm

Ø3 mm
1/2
Ø8 mm

WULLSTEIN
JJ-24-154 1.5 mm
JJ-24-155 2 mm
Suction tube, cylindrical, silver, with
stylet with LUER hub
16 cm

1/2
Ø8 mm

Usable length

YASARGIL usable length diam.

JJ-24-156	13 cm	1.5 mm
JJ-24-157	15 cm	1.5 mm
JJ-24-158	18 cm	1.5 mm
JJ-24-159	22 cm	1.5 mm
JJ-24-160	13 cm	2 mm
JJ-24-161	15 cm	2 mm
JJ-24-162	18 cm	2 mm
JJ-24-163	22 cm	2 mm

YASARGIL usable length diam.

JJ-24-164	13 cm	2.5 mm
JJ-24-165	15 cm	2.5 mm
JJ-24-166	18 cm	2.5 mm
JJ-24-167	22 cm	2.5 mm
JJ-24-168	13 cm	3.5 mm
JJ-24-169	15 cm	3.5 mm
JJ-24-170	18 cm	3.5 mm
JJ-24-171	22 cm	3.5 mm

Ø6.5-9 mm
with LUER hub

LANDOLT
JJ-24-172 - JJ-24-174
15 cm
diam Ø 3 mm

JJ-24-172 8 mm / curved
JJ-24-173 11mm / curved
JJ-24-174 15mm / curved

Ø3.5 mm

Ø2.0 mm

JJ-24-175 5 cm
JJ-24-176 35 cm
with rubber tip,
with LUER hub

Ø9 mm

JJ-24-177 2 mm diam
JJ-24-178 2.5 mm diam
JJ-24-179 3 mm diam
with finger cut-off,
thumb piece 90° to
curved, with LUER hub
25 cm

Ø6-9 mm

COMBINED SUCTION AND IRRIGATION CANNULA

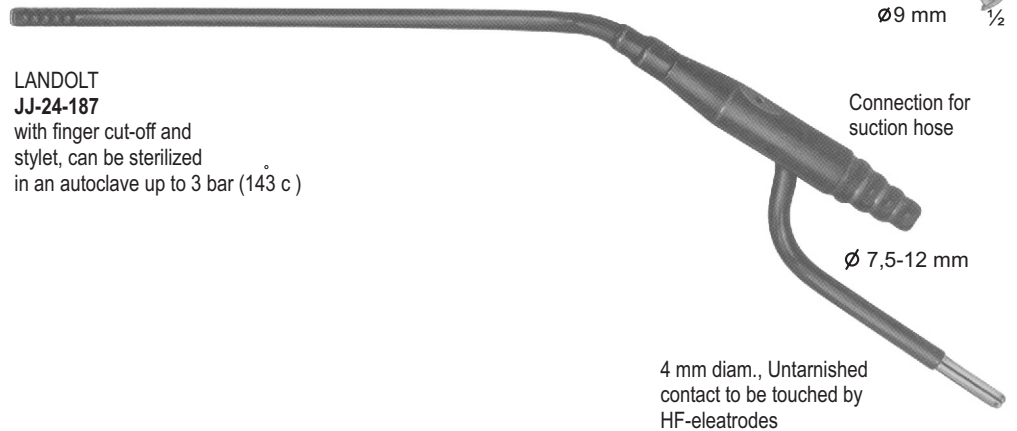
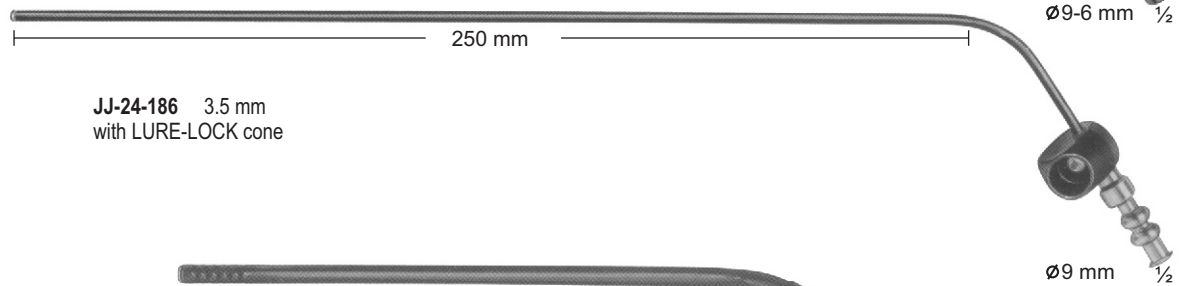
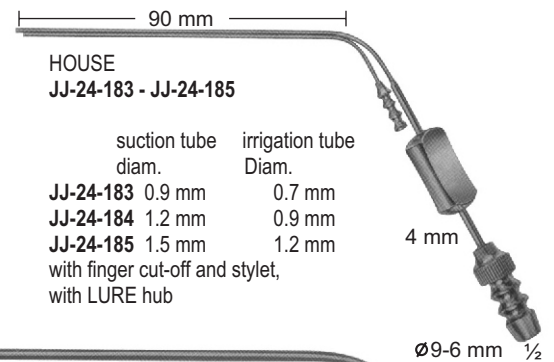
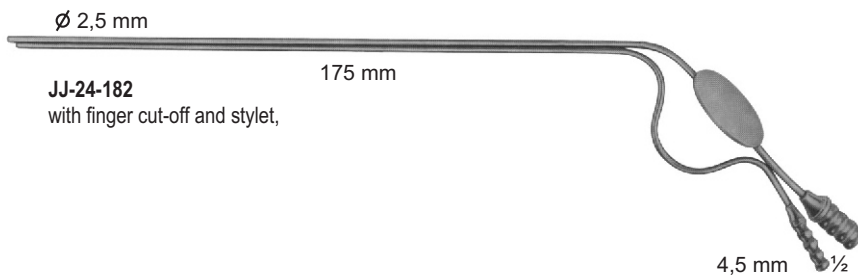
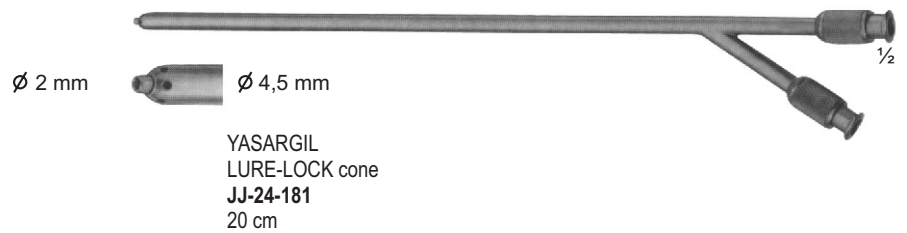
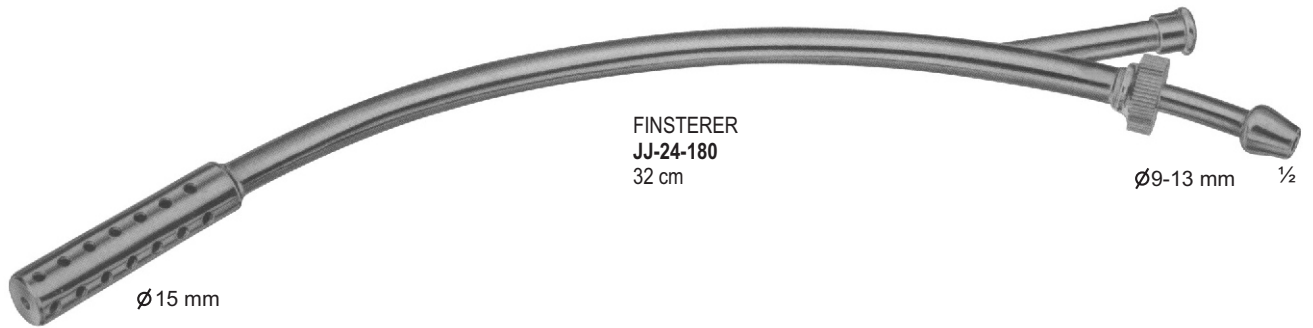



WULLSTEIN
JJ-24-188 - JJ-24-190
14 cm
handle with tube, only



WULLSTEIN
JJ-24-188
4.5 cm
Micro Suction Cannula
Complete, with handle and 3 tips
Ø 0.4 mm



WULLSTEIN
JJ-24-189
4.5 cm
Micro Suction Cannula
Complete, with handle and 3 tips
Ø 0.6 mm



WULLSTEIN
JJ-24-190
4.5 cm
Micro Suction Cannula
Complete, with handle and 3 tips
Ø 0.8 mm



BARON-SCHUKNECHT
JJ-24-191 - JJ-24-193
with finer cut-off



JJ-24-191
working length 75 mm
Ø 1 mm



JJ-24-192
working length 75 mm
Ø 1.5 mm



JJ-24-193
working length 75 mm
Ø 2 mm



ZOELLNER
JJ-24-194 - JJ-24-197
Suction Cannula

Suction Tip

- JJ-24-194 Ø0.5 mm
- JJ-24-195 Ø0.7 mm
- JJ-24-196 Ø0.9 mm
- JJ-24-197 Ø1.2 mm

SUCTION INSTRUMENTS

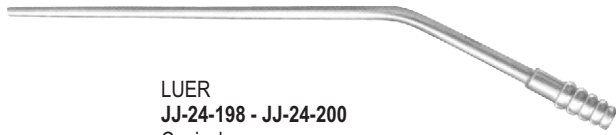

LUER
JJ-24-198 - JJ-24-200
Conical

1/2



JJ-24-198
16.5 cm
Ø 3 mm
working length
110 mm

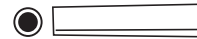

JJ-24-199
16.5 cm
Ø 3.5 mm
working length
110 mm



JJ-24-200
18 cm
Ø 4.5 mm
working length
130 mm

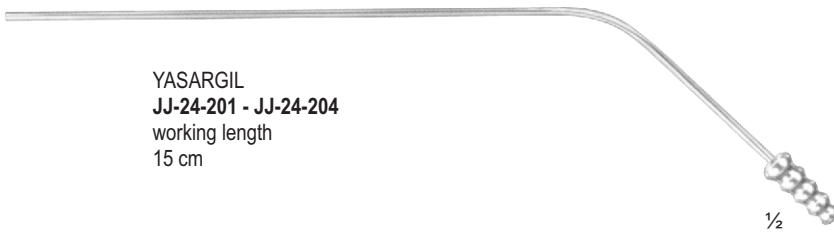

YASARGIL
JJ-24-201 - JJ-24-204
working length
15 cm

1/2



JJ-24-201
17 cm
Ø 1.5 mm

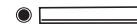

JJ-24-202
17 cm
Ø 2 mm



JJ-24-203
17 cm
Ø 2.5 mm



JJ-24-204
17 cm
Ø 3.5 mm

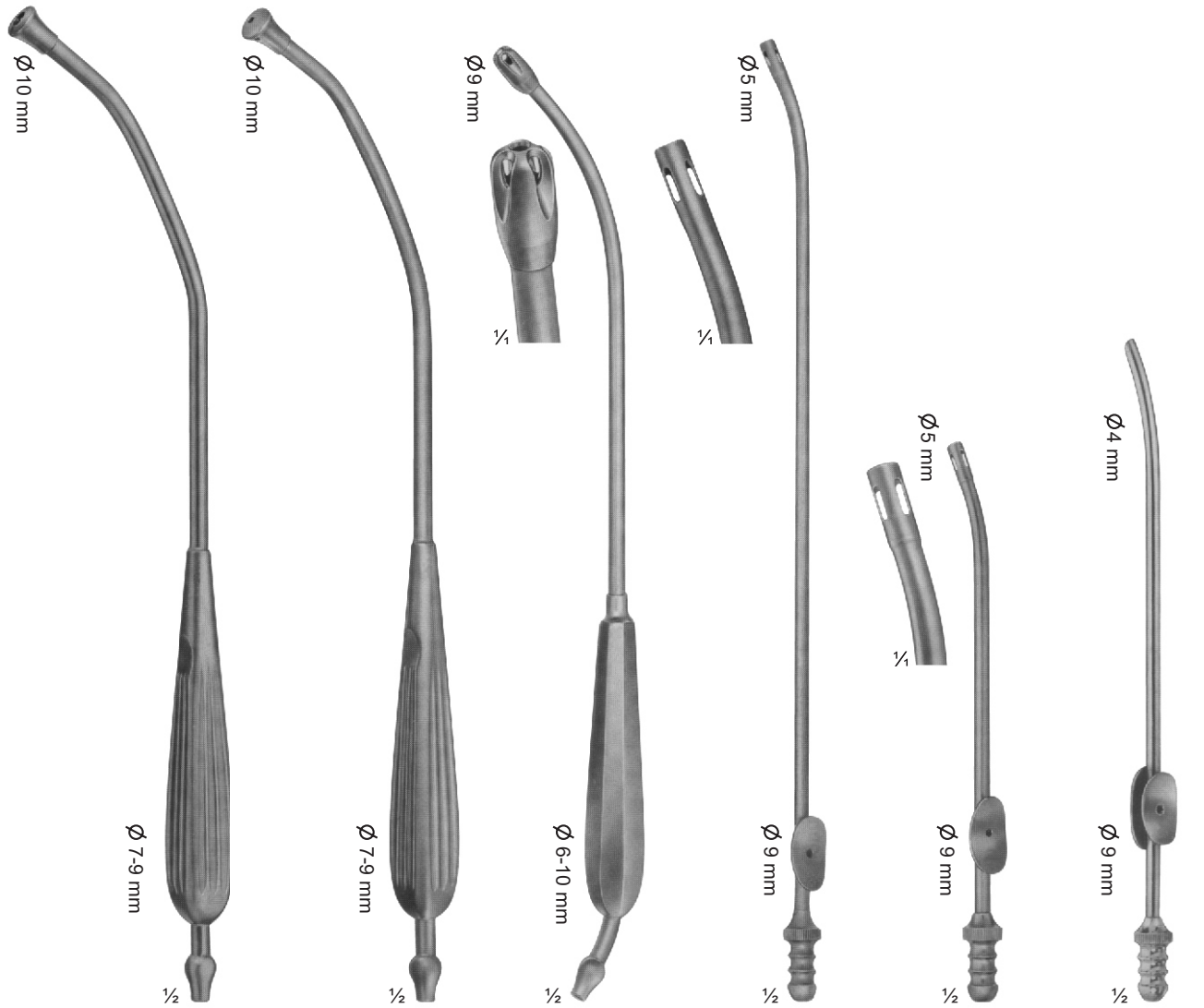

JJ-24-205
YANKAUER
with especially large
central bore, 4,8 mm
diam.
285 mm

JJ-24-206
YANKAUER
with central bore,
2,0 mm diam.
285 mm

JJ-24-207
DE-BAKEY
with central bore,
3,0 mm diam.with
lateral slots
275 mm

JJ-24-208
DE-BAKEY
with finger cut-off
and stylet
270 mm

JJ-24-209
DE-BAKEY
with finger cut-off
and stylet
160 mm

JJ-24-210
with finger
cut-off
190 mm

SUCTION INSTRUMENTS

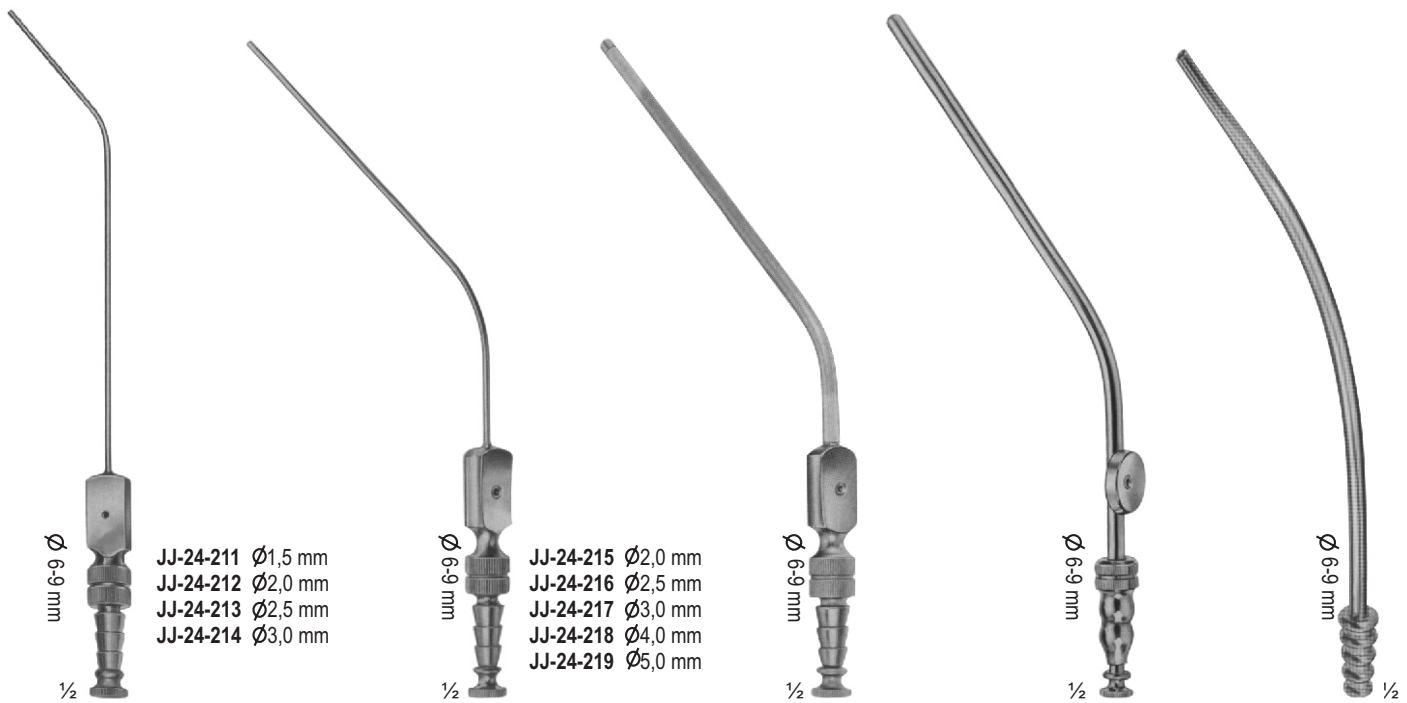

\varnothing 6-9 mm
 1/2
JJ-24-211 \varnothing 1,5 mm
JJ-24-212 \varnothing 2,0 mm
JJ-24-213 \varnothing 2,5 mm
JJ-24-214 \varnothing 3,0 mm

\varnothing 6-9 mm
 1/2
JJ-24-215 \varnothing 2,0 mm
JJ-24-216 \varnothing 2,5 mm
JJ-24-217 \varnothing 3,0 mm
JJ-24-218 \varnothing 4,0 mm
JJ-24-219 \varnothing 5,0 mm

\varnothing 6-9 mm
 1/2
JJ-24-220 \varnothing 4,0 mm
JJ-24-221 \varnothing 3,0 mm
JJ-24-222 \varnothing 5,0 mm

\varnothing 6-9 mm
 1/2
JJ-24-223

JJ-24-211 - JJ-24-214
PLESTER
 with finger cut-off and
 stylet, thumb piece
 parallel to curved, with
 LUER hub
 195 mm

JJ-24-215 - JJ-24-219
FERGUSON
 with finger cut-off and
 stylet, thumb piece
 90° to curved, with
 LUER hub
 180 mm

JJ-24-220 \varnothing 4,0 mm
FERGUSON
 insulated, with finger cut-off
 and stylet, thumb piece 90°
 to curved, with LUER hub
 180 mm

JJ-24-221 \varnothing 3,0 mm
JJ-24-222 \varnothing 5,0 mm
FRAZIER
 insulated, with finger
 cut-off and stylet, thumb
 piece 90° to curved,
 with LUER hub
 180 mm

JJ-24-223
 5,0 mm diam., Tip
 6,5 mm wide, Nasal
 suction tube, with
 LUER hub
 180 mm



JJ-24-224 Ø4,5 mm
JJ-24-225 Ø5,5 mm
Nasal suction tubes
175 mm



JJ-24-226
GORNEY
Suction dissector
180 mm



JJ-24-227 4 mm wide
JJ-24-228 5 mm wide
Suction raspatories, sharp, bayonet-shaped, with styelt
200 mm



JJ-24-229
LOPEZ-REINKE
Tonsil dissector with suction device
235 mm



JJ-24-230
SPACKMAN CANNULA
Surgical and Latexfree
Cone the depth of the uterus and to allow for gentle dilation of the cervix
Length: 360 mm



Jordi & Jamil Instruments

 MachiKhokhar, Marala road,
Sialkot, 51310, Pakistan.

 +92 328 615 6070

 info@jjordiinst.com

 www.jjordiinst.com



Our Certifications:

ISO 9001

CE Certified

EN 13485:2012

ISO 7153-1

ISO 7151

ISO 17664:2004

ISO 13402

ISO 15223

